



Camaro Z/28
1969





The '69 Z/28. So ominous it goes by its code name. Cable Latch: 302. Standard equipment: mechanical lifters, high-performance cam and an aluminum intake manifold under a massive Holley 4-barrel. Underneath, multi-leaf rear springs and heavy-duty shocks. New '69 are special white lettered tires on 15 x 7-inch wide wheels and a Hurst shifter for the 4-speed. To complete the setup, just add the new 'Vette-type 4-wheel power disc brakes. By now you know the mean streak isn't just painted on—it's built in. One more thing. People are bound to ask what the Z stands for. Tell them "Zaps!" **Putting you first, keeps us first.**

LE COUPÉ SPORTIF

Abordables, sportives et élégantes, les voitures compactes, ou « Pony Cars » ont révolutionné l'industrie automobile lorsqu'elles sont apparues au milieu des années 1960. Une nouvelle génération de jeunes conducteurs a été immédiatement attirée par les lignes aérodynamiques, le capot allongé et le moteur puissant de ces modèles. Bien que presque tous les constructeurs automobiles aient lancé leur propre « pony car », peu ont eu autant de succès que Chevrolet avec l'émblématique Camaro.

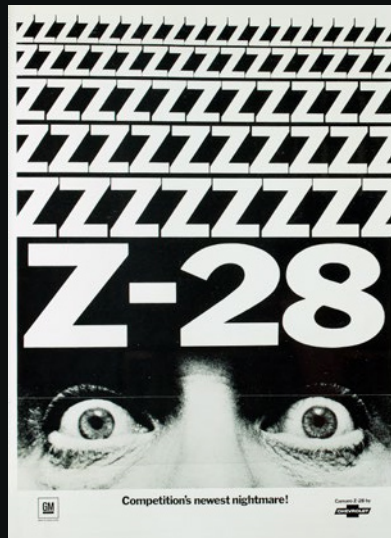

The skier's skier with the Camaro's Camaro.



There are skiers. And then there are skiers. Jean-Claude Killy is one of the latter.

The Camaro Z/28 is a special breed, too. It comes poised on a beefed-up suspension and special road-grabbing wide oval tires.

Under that striped hood is a tough 302 V8 that inhales through a big Holley 4-barrel and exhales through dual exhausts.

Z/28

Add four-on-the-floor with a Hurst shifter plus 4-wheel power disc brakes and you've got the closest thing to a 'Vette yet. Z/28. In our Sports Department. Almost as much fun as skiing.

Putting you first, keeps us first.

See Olympic Gold Medalist Jean-Claude Killy, Sundays, CBS-TV. Check your local TV listings.

69 CH-43 A
Ski February
February
1 page-4 colors
A P 7729-11 21 68-5



UN SUCCÈS RETENTISSANT

La Chevrolet Camaro Z28 de deuxième génération incarne toujours la super voiture parfaite. Lancés en 1969, le capot « cowl induction » et les lignes de vitesse estampées dans les ailes et les portes ont assuré son originalité. Refusant les emprunts à d'autres modèles de l'époque, cette voiture a toujours l'air aussi originale et audacieuse plus de 50 ans plus tard.



camaro

Camaro

CAMARO



1967 – 1969

1970 – 1981

1982 – 1992

UNE ICÔNE AUTOMOBILE

Bien que 55 années se soient écoulées depuis le lancement de la première Chevrolet Camaro, cette célèbre voiture est toujours aussi populaire et actuelle, tandis que la sixième génération de ce véhicule emblématique est en production aujourd'hui. Appréciés par les passionnés de super voitures et présentés dans d'innombrables jeux vidéo, émissions de télévision, films et pop culture, la marque et le nom de ce modèle continuent de fasciner toutes les générations.

CAMARO

CAMARO



1993 - 2002

2010 - 2015

2016 -



LES MOTS DE L'ÉQUIPE DE DESIGN

« Je suis passionné de voitures et je feuillette des magazines auto depuis mon plus jeune âge. Mon rêve s'est donc réalisé lorsque j'ai eu la possibilité de développer ce modèle LEGO® avec de vrais designers de voitures Chevrolet. Nous avons dû recréer le style et la position adéquats du modèle, mais aussi ajouter des détails amusants mais essentiels comme des portes et une direction fonctionnelles. J'ai également beaucoup aimé proposer des options de personnalisation, comme sur la Camaro originale. »

Sven Franic, designer LEGO®



VOTRE MODÈLE. VOTRE CHOIX.

L'une des caractéristiques les plus appréciées de la Camaro originale est la vaste gamme d'options de personnalisation et de moteurs haute performance proposée. Vous avez donc vous aussi la possibilité de décider comment styliser votre version LEGO® de la voiture : s'agit-il d'un coupé à toit rigide ou d'un cabriolet ? Et qu'en est-il des rayures ? Vous les voulez blanc classique, gris subtil ou rouge vif ? Des couvre-phares sont également proposés en option, ainsi que deux plaques d'immatriculation au choix.



Les trois modèles ne peuvent être construits simultanément.

Vous trouverez les instructions pour construire ces modèles en ligne sur [LEGO.com/buildinginstructions](https://www.lego.com/buildinginstructions)



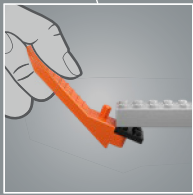
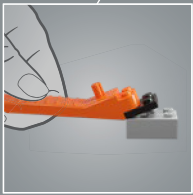
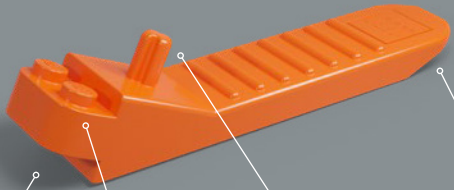
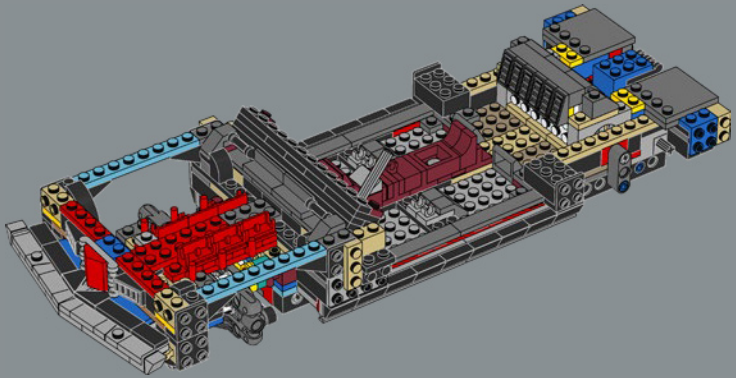
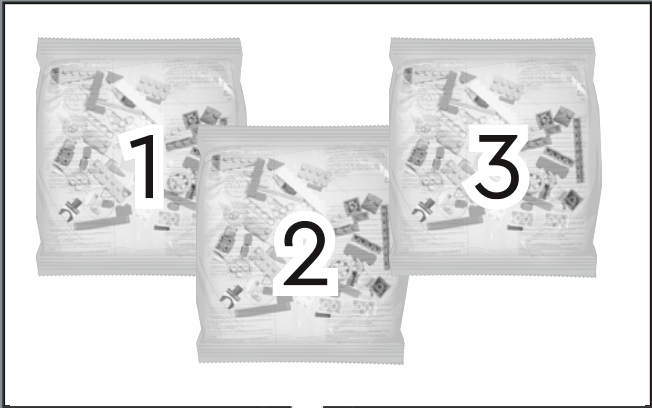

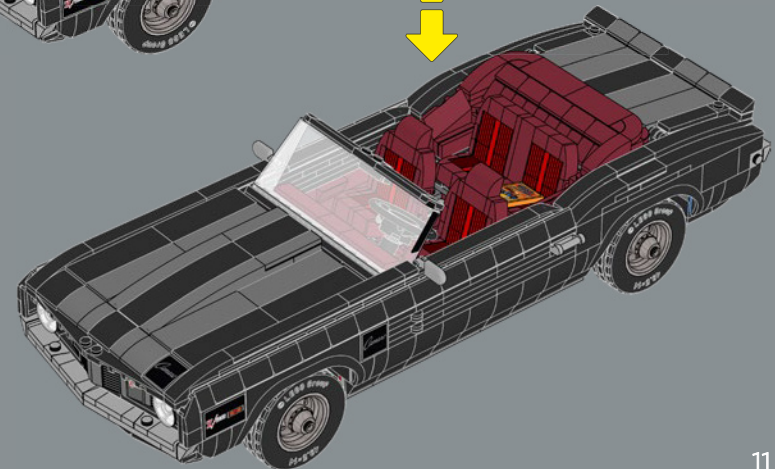
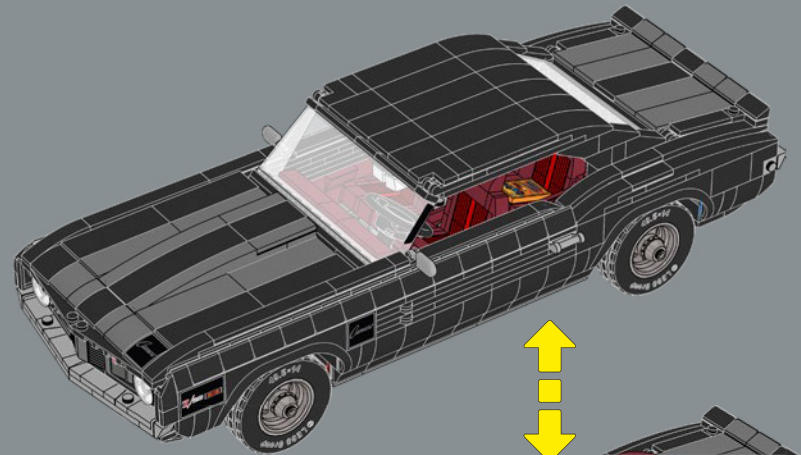
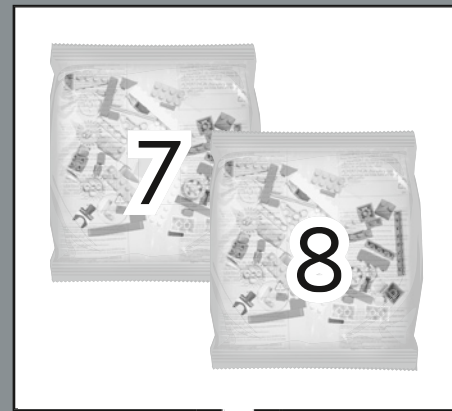
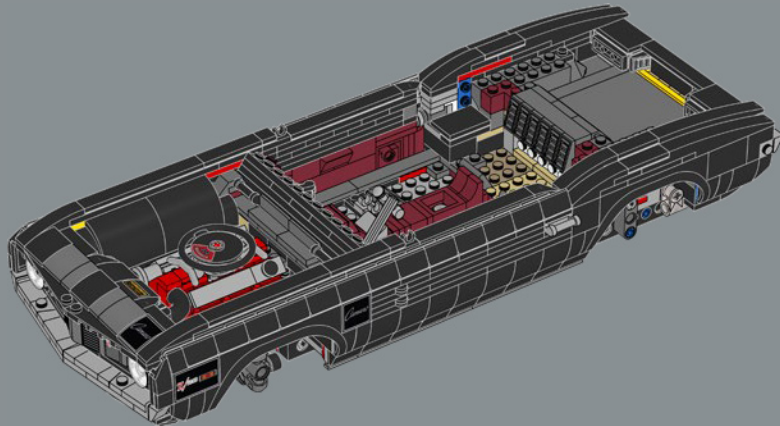
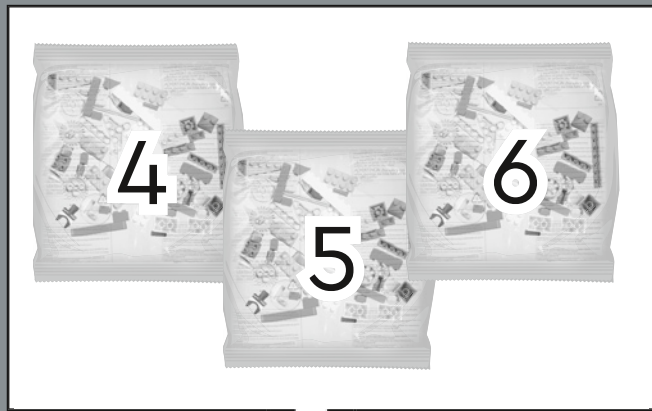

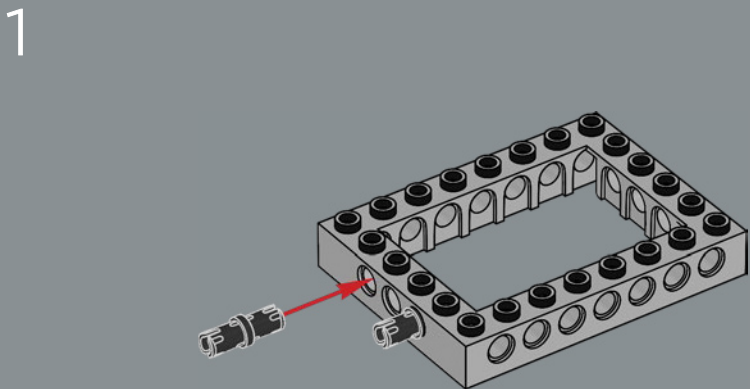
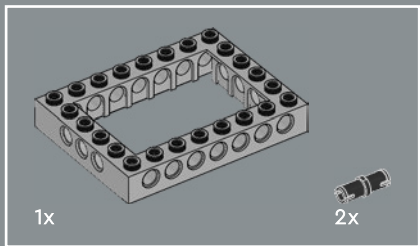

2

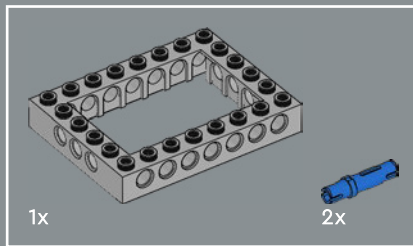
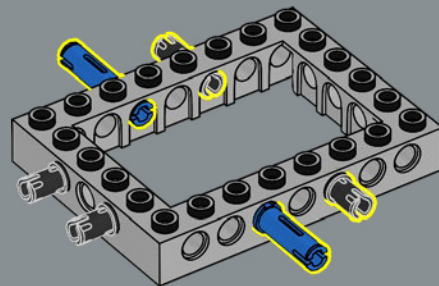

3

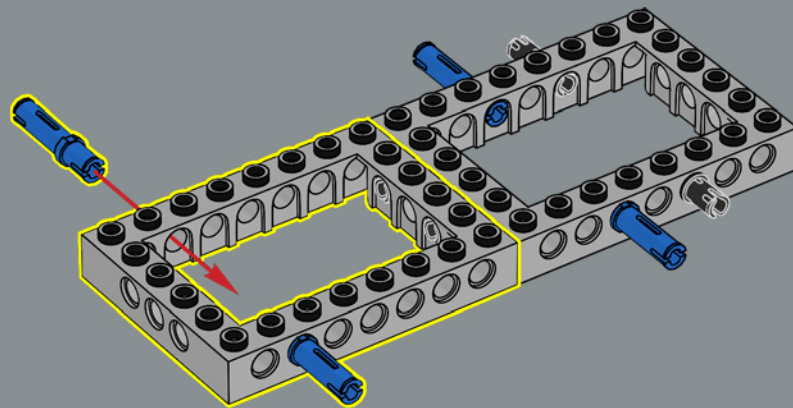

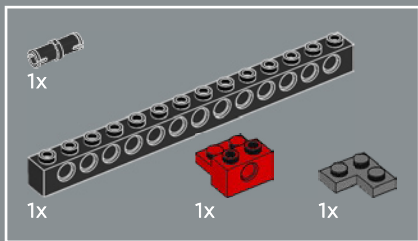

4

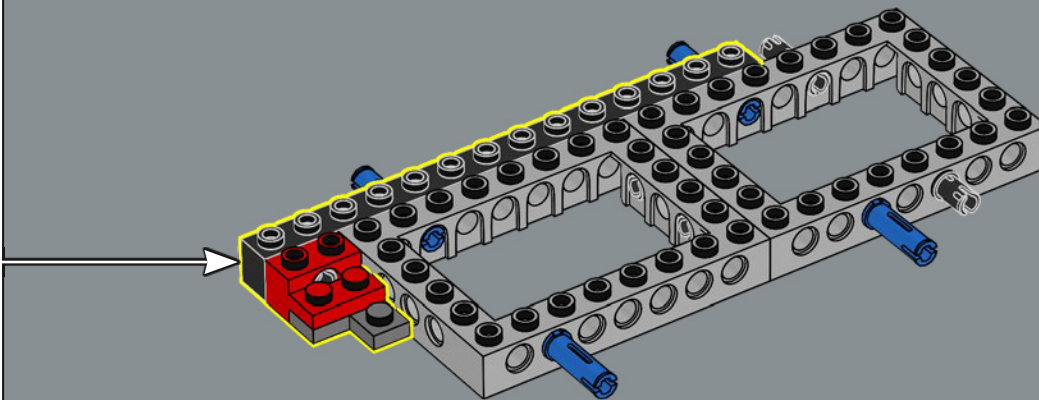
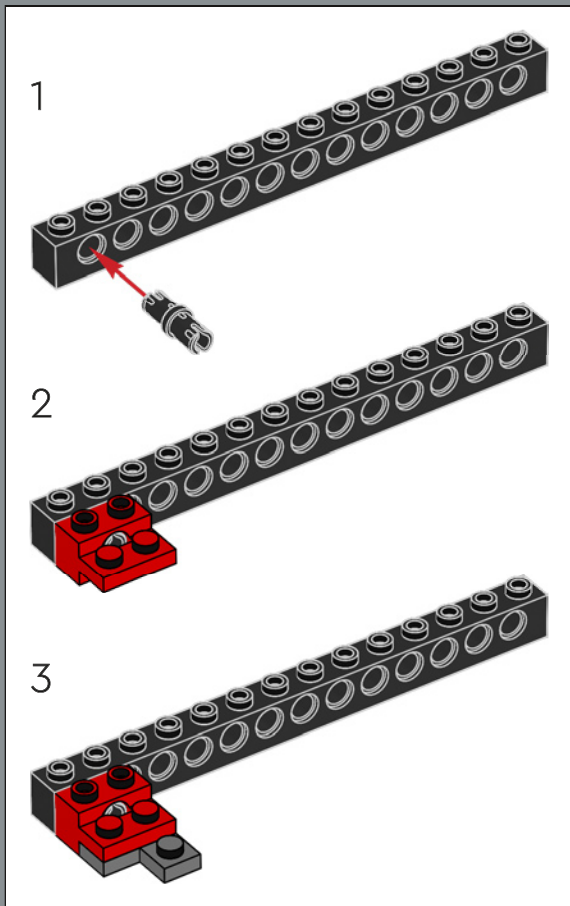

À l'instar de la plupart des modèles
Chevrolet (Corvaire, Corvette, Chevelle, etc.),
Camaro commence par la lettre « C ».

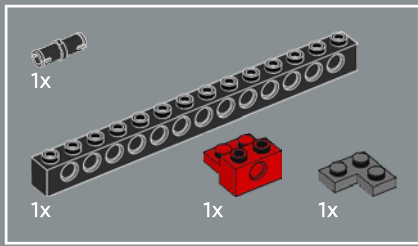

5

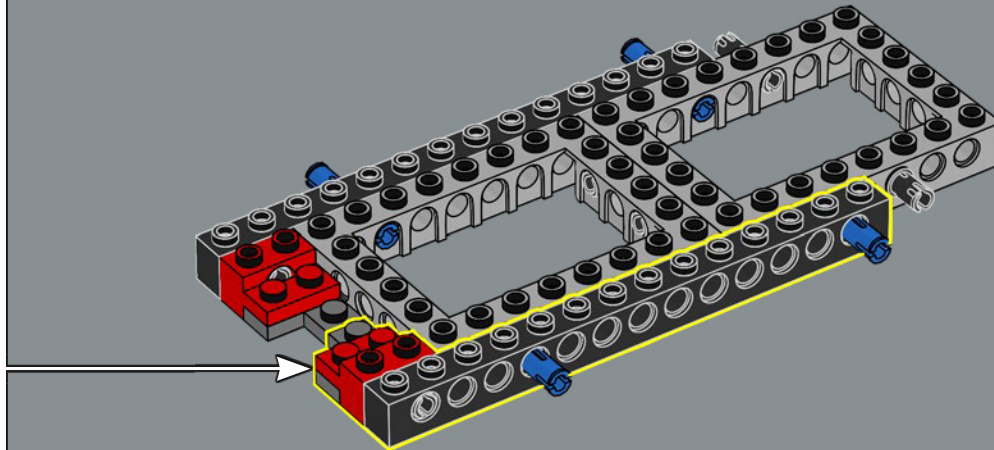
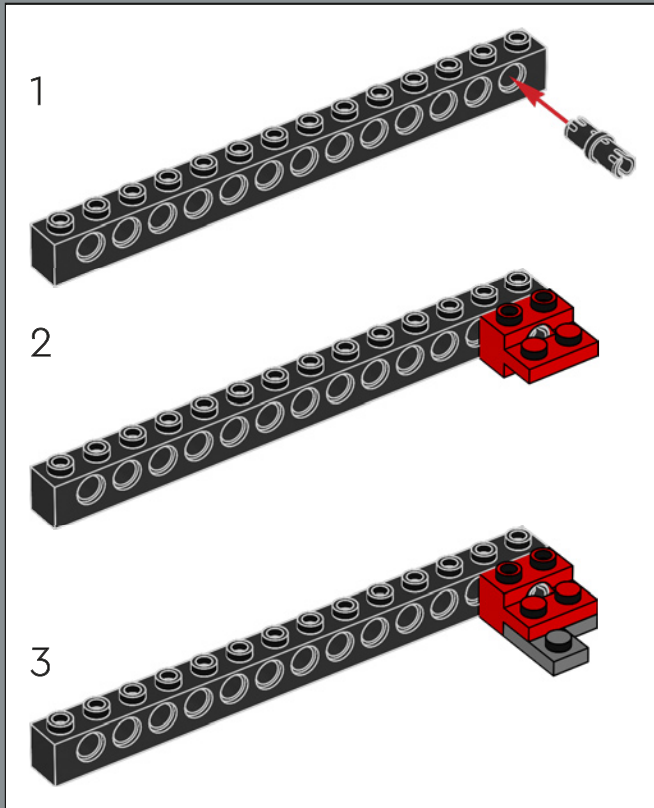

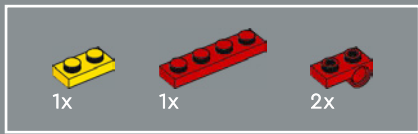

6

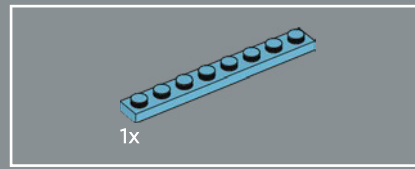
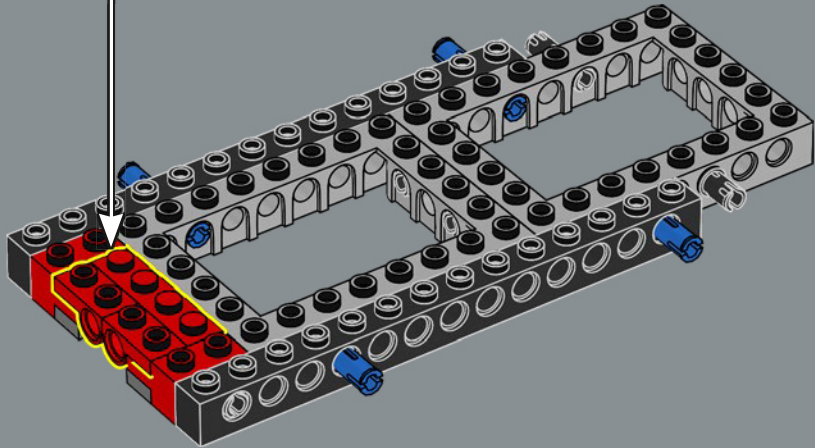
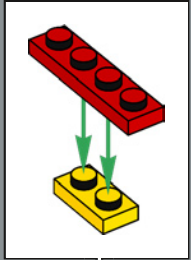

7

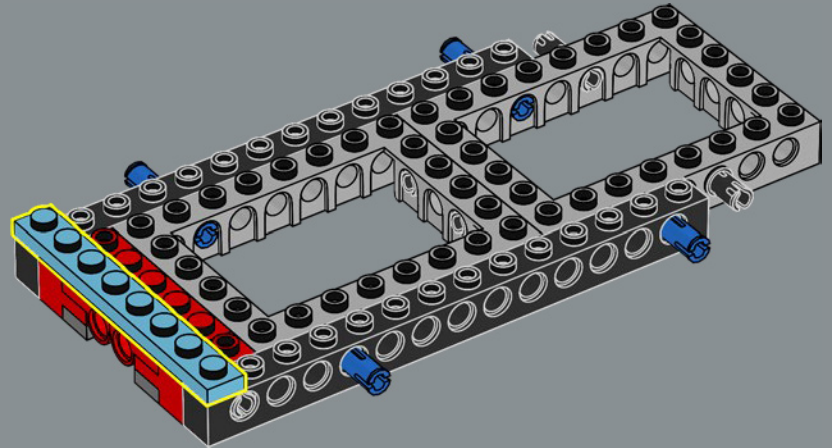

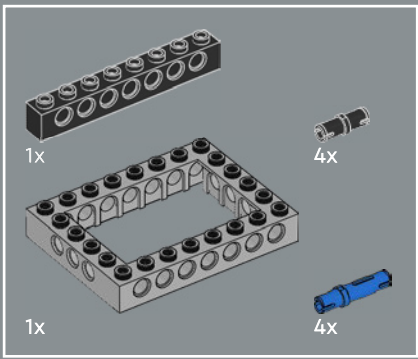

8

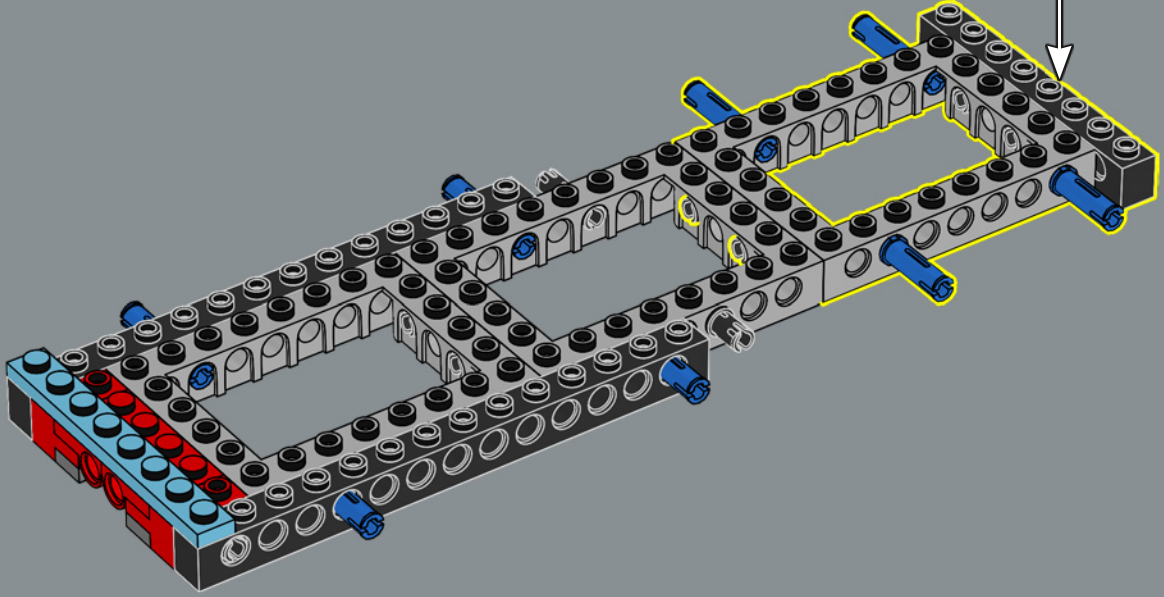
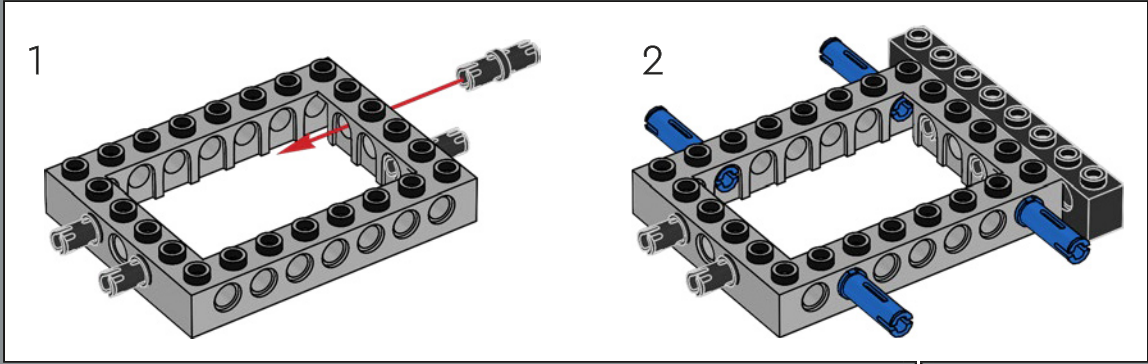

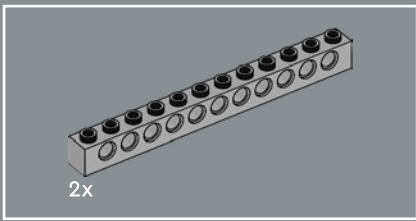

9

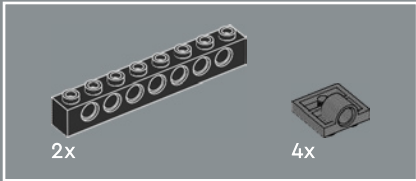
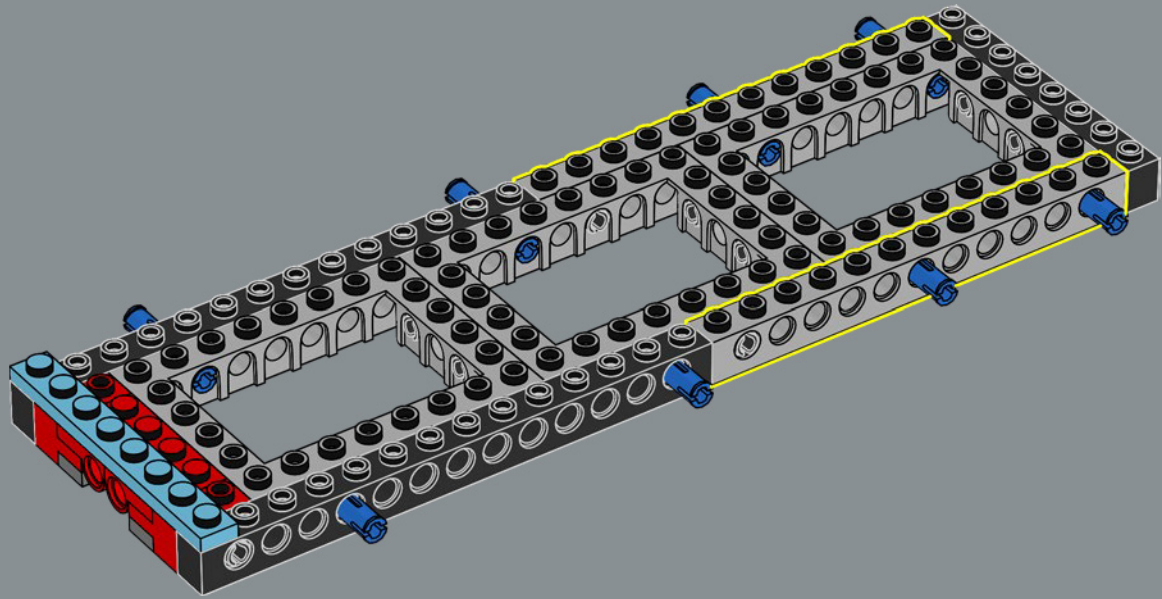

10

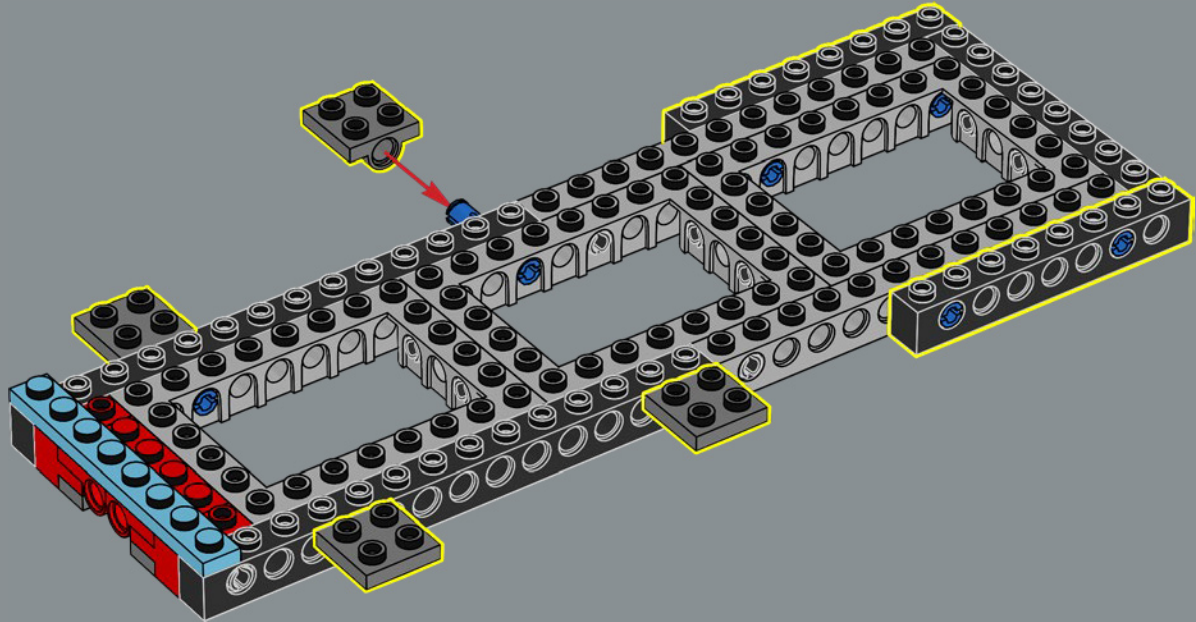

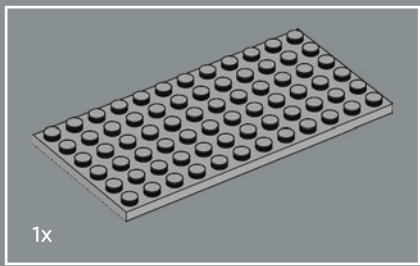

11

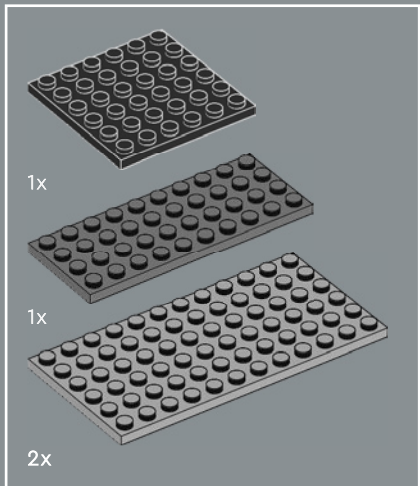
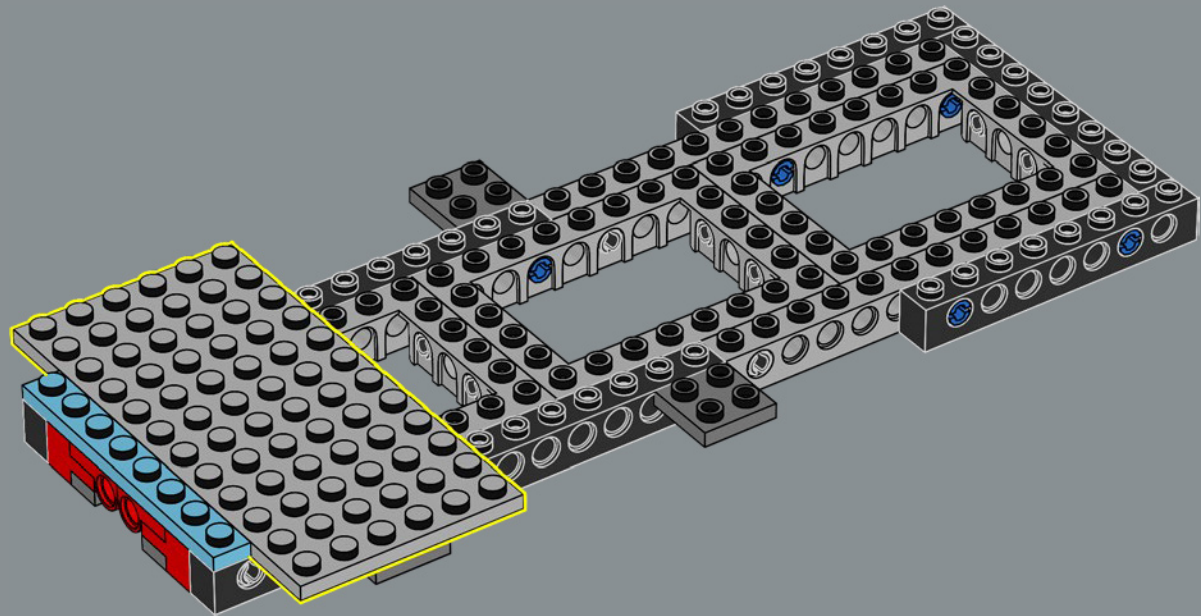

12

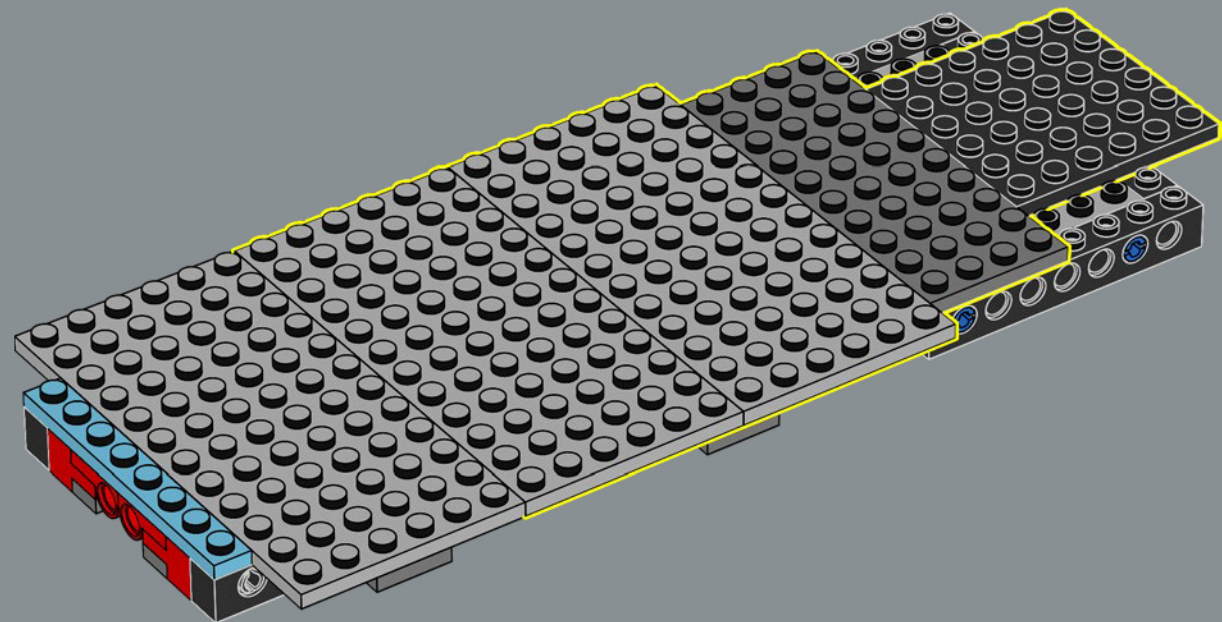



13

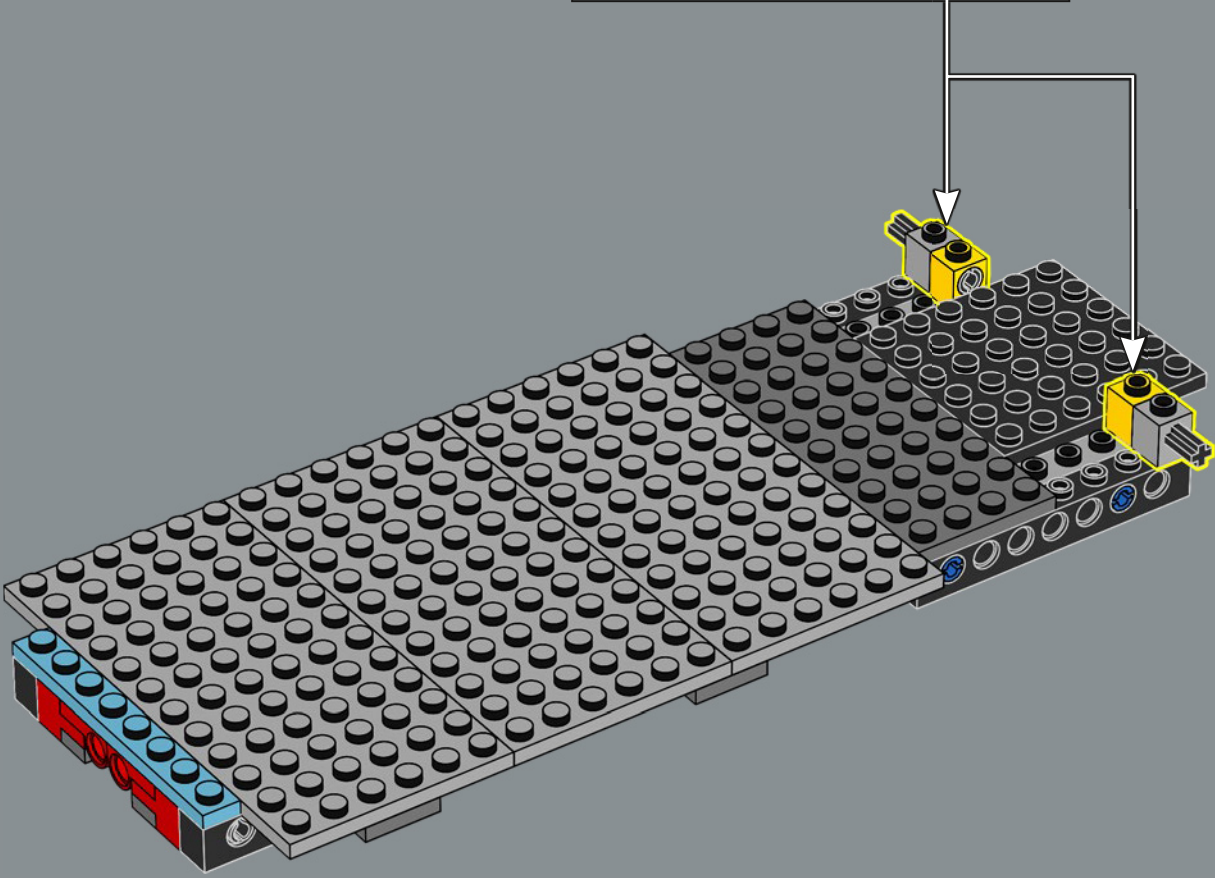
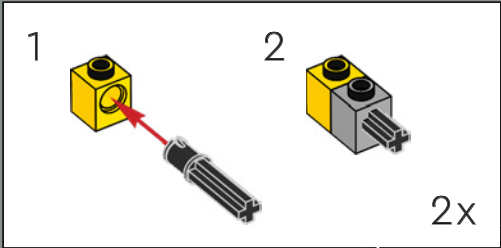

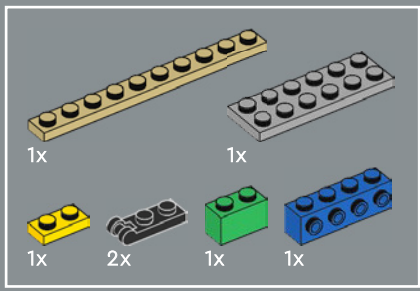

14

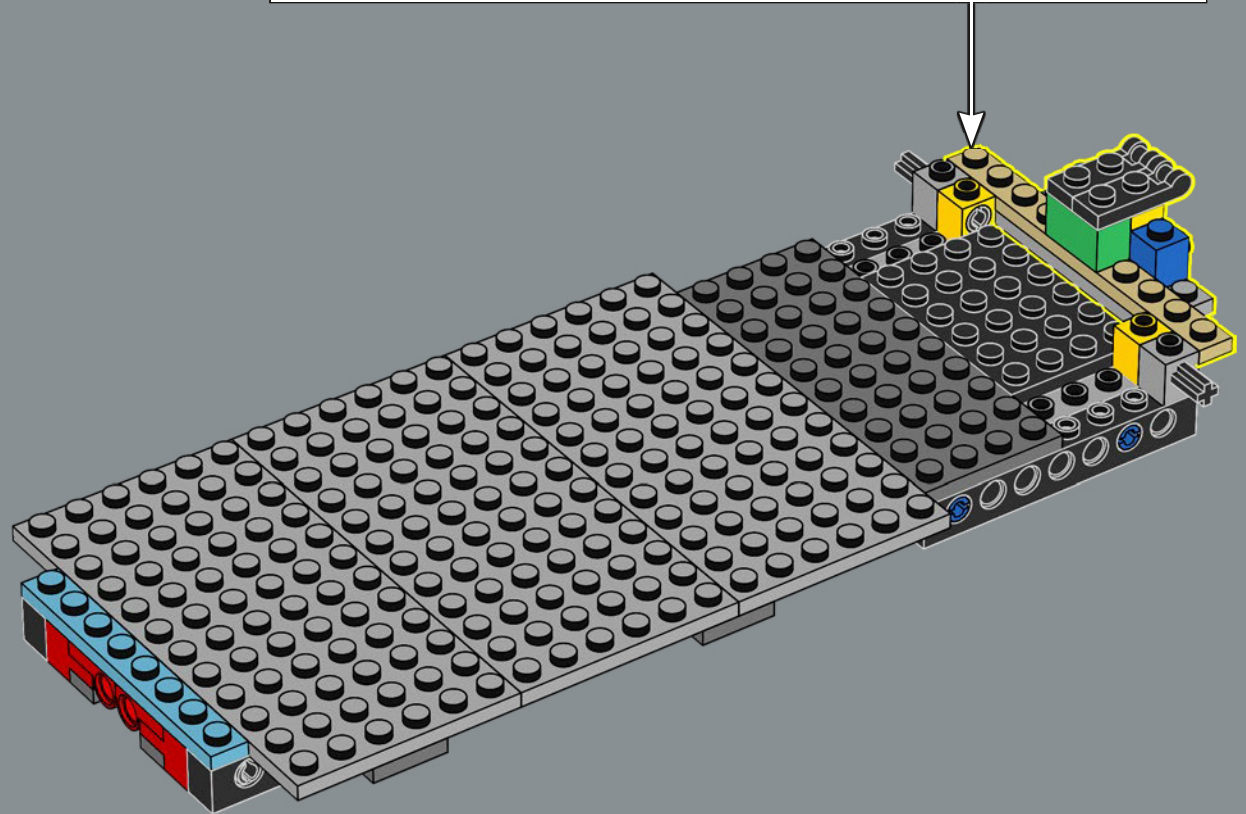
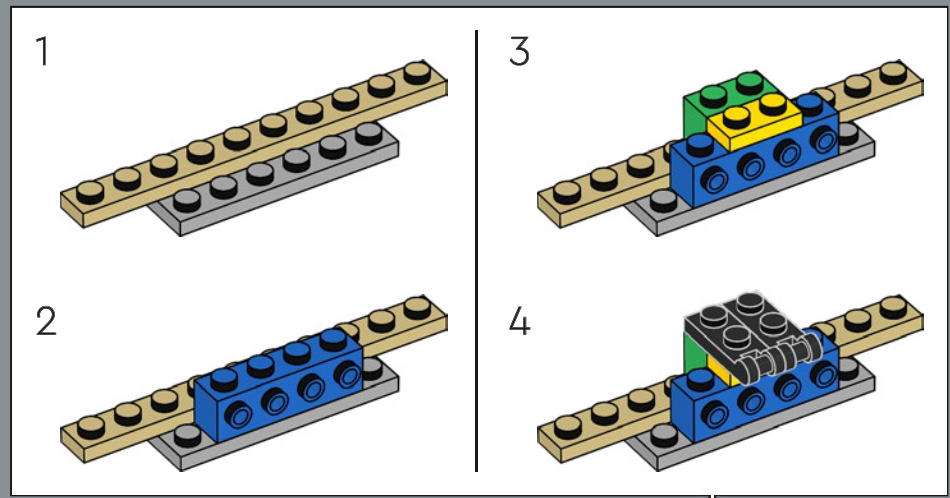

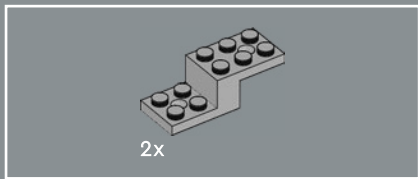

15

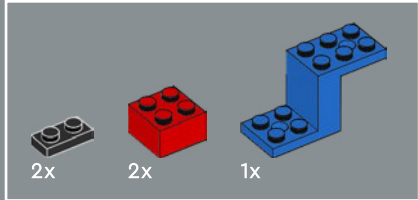
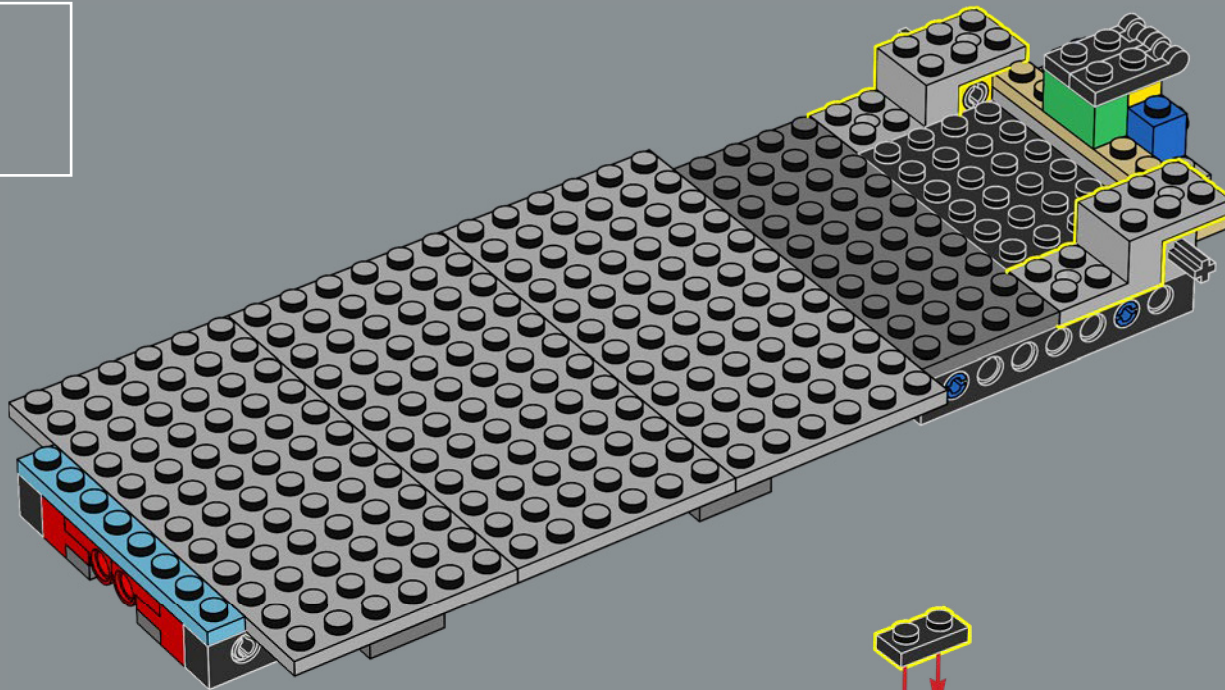

16

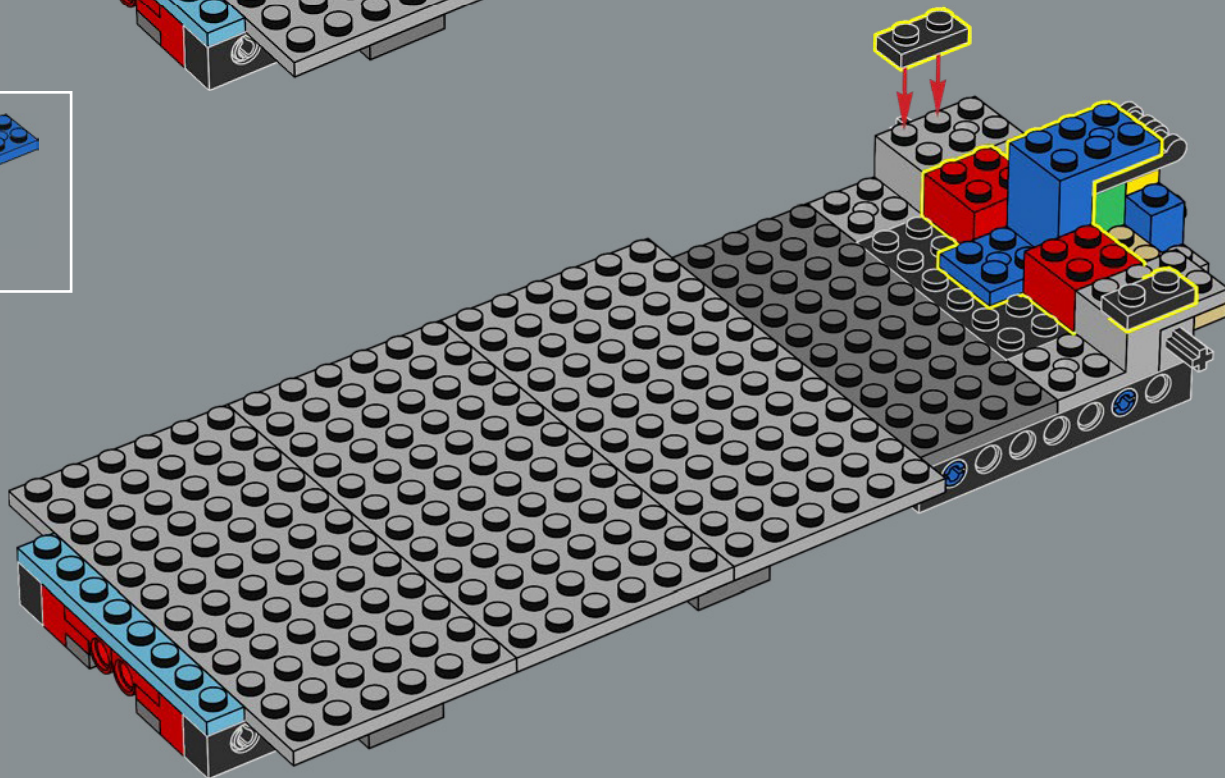

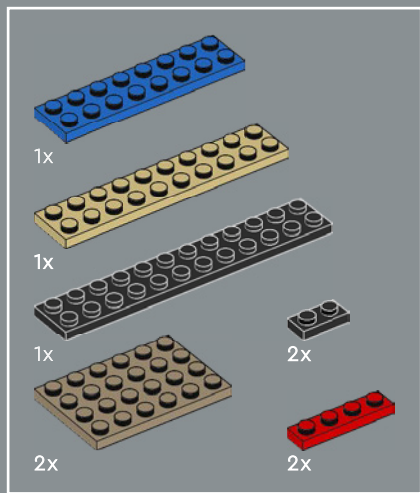

17

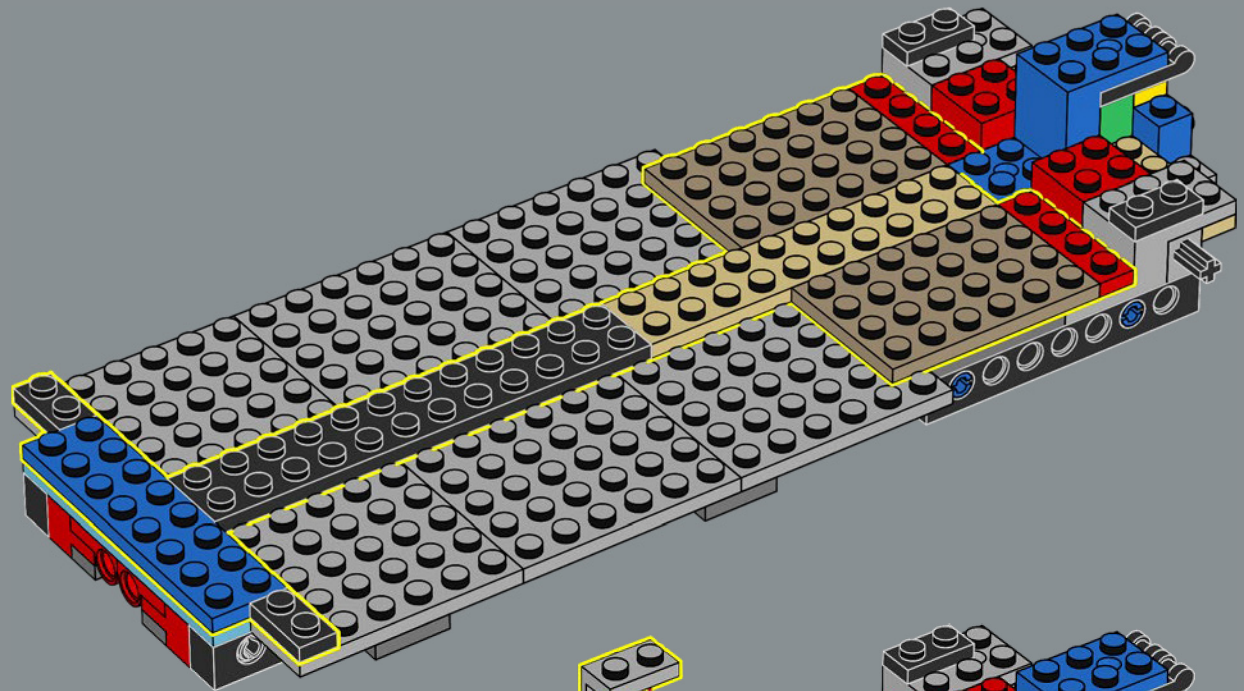

18

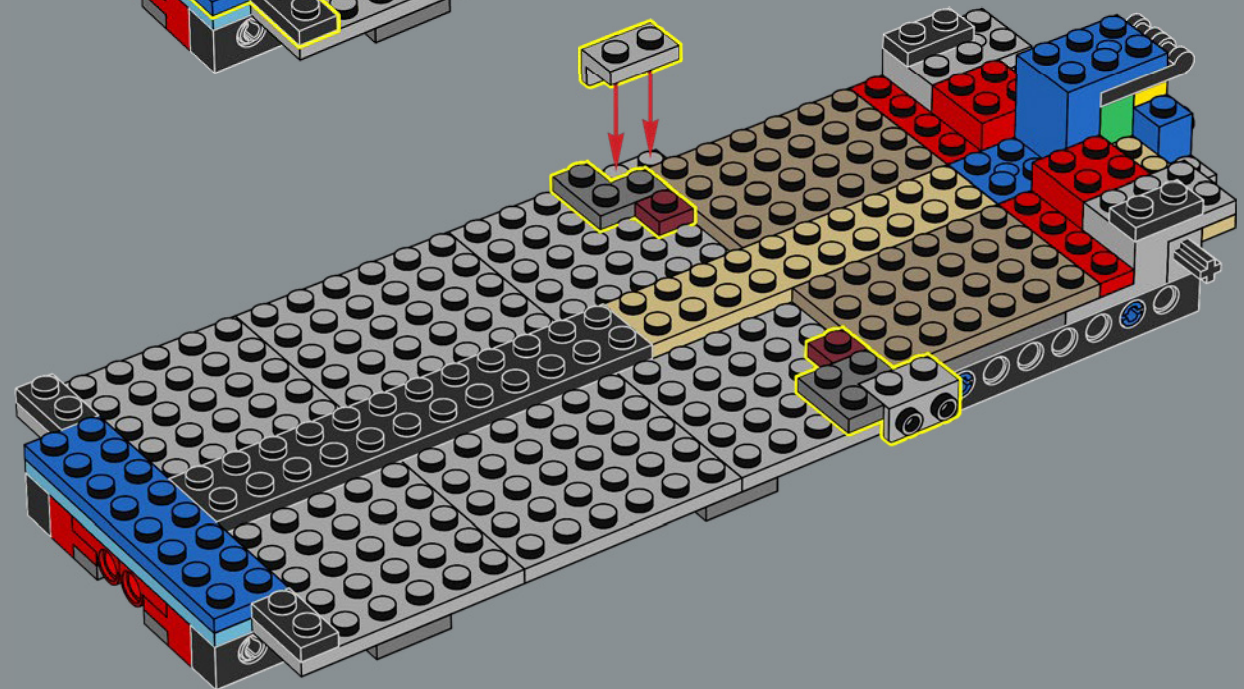



19

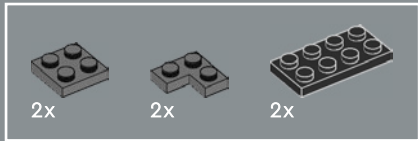
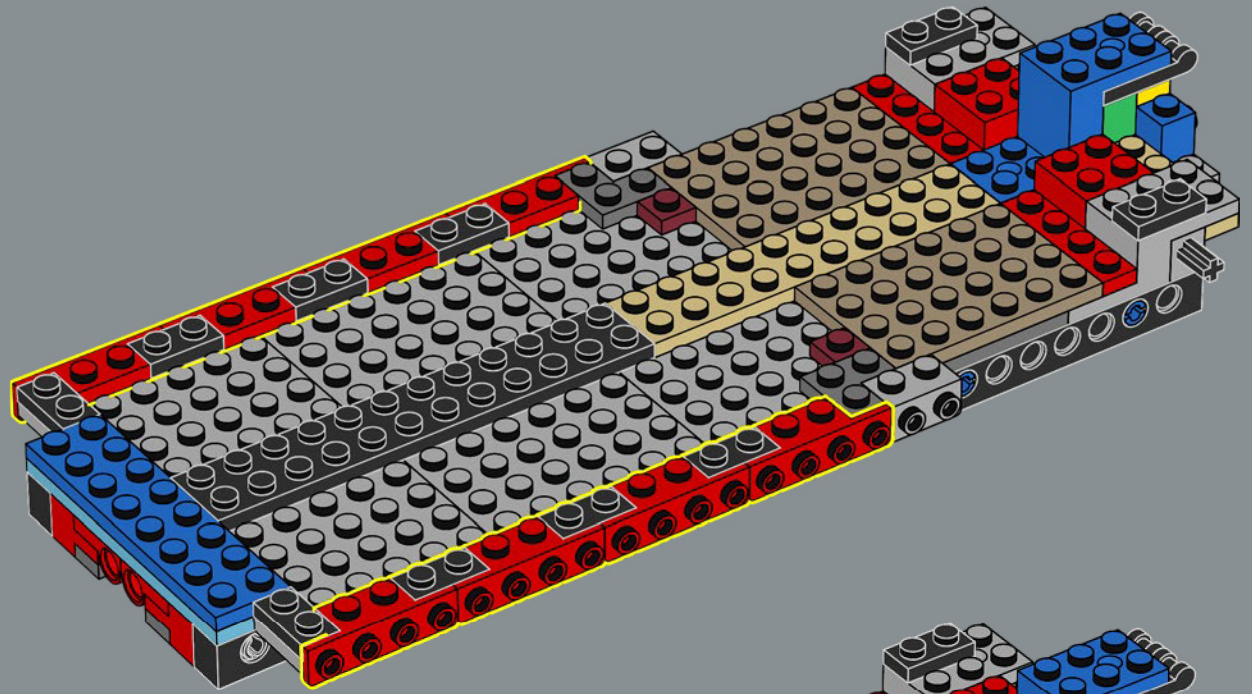

20

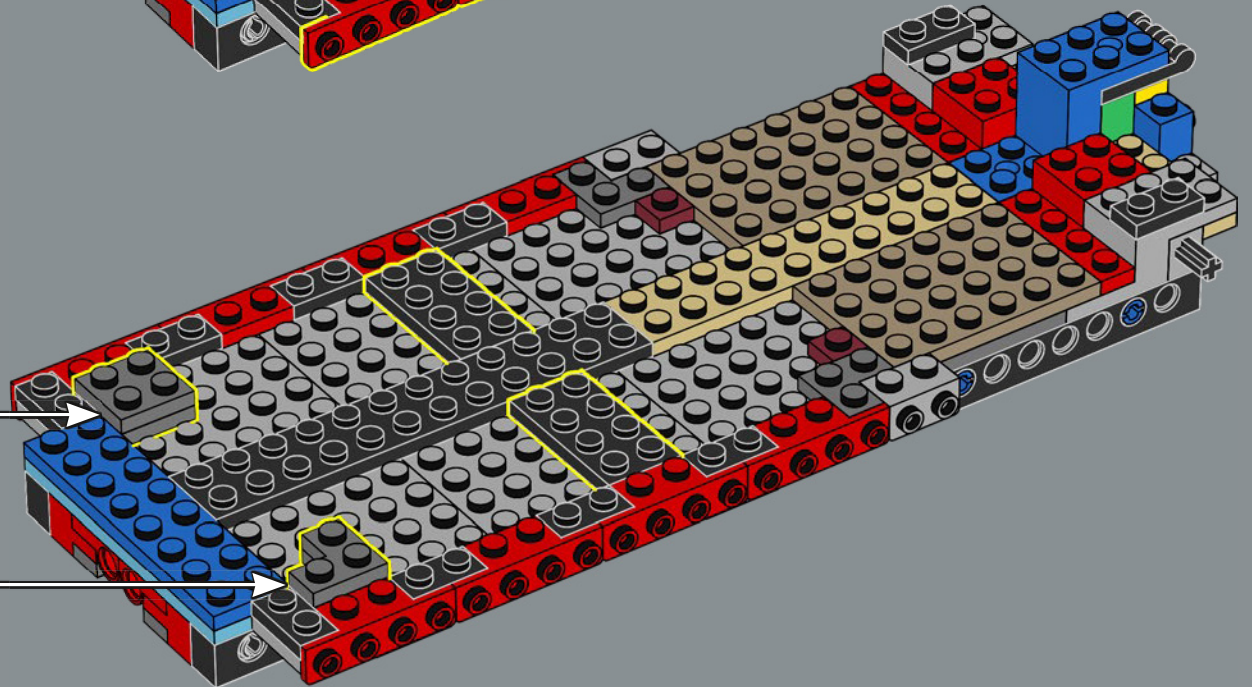
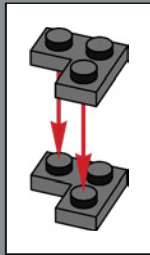
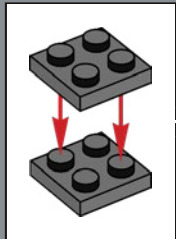

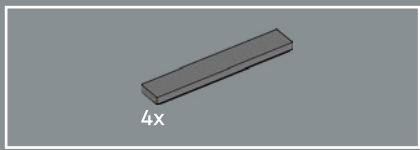

21

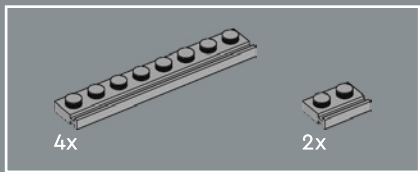
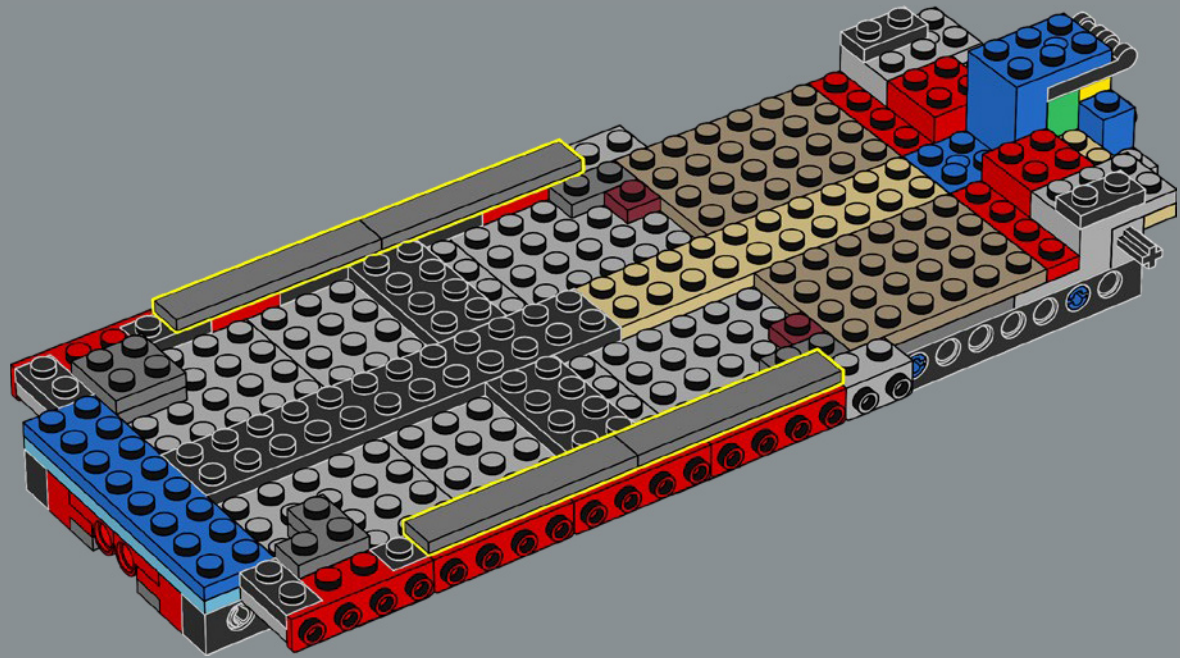

22

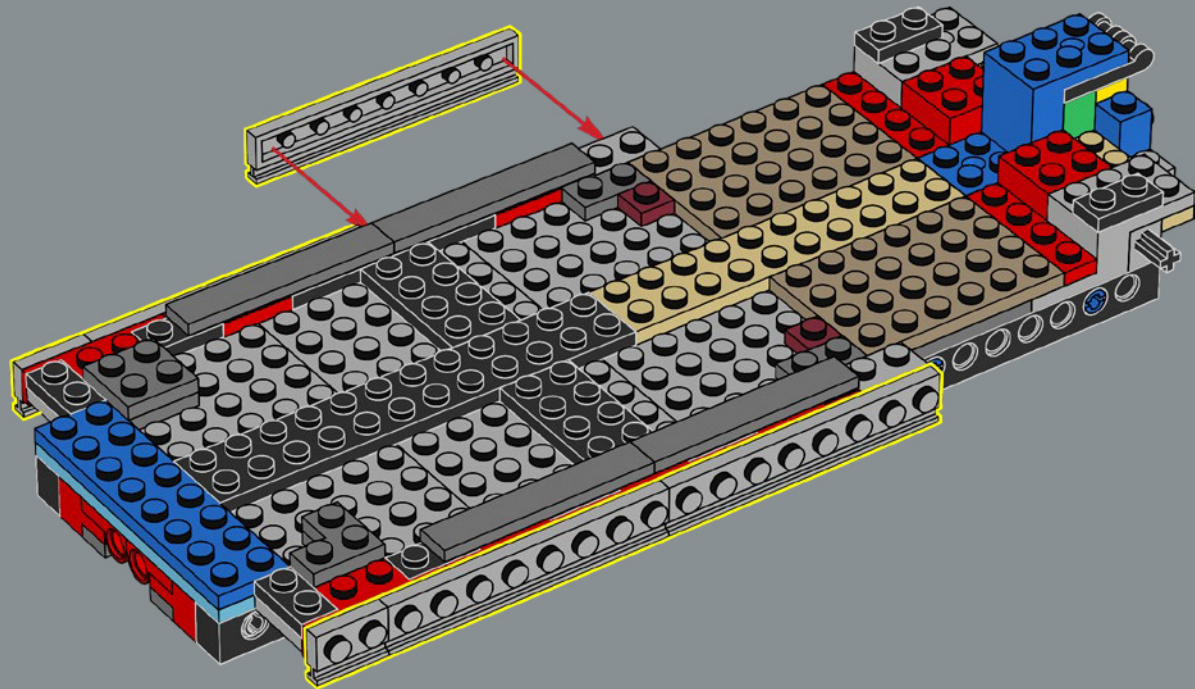



23

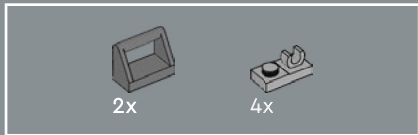
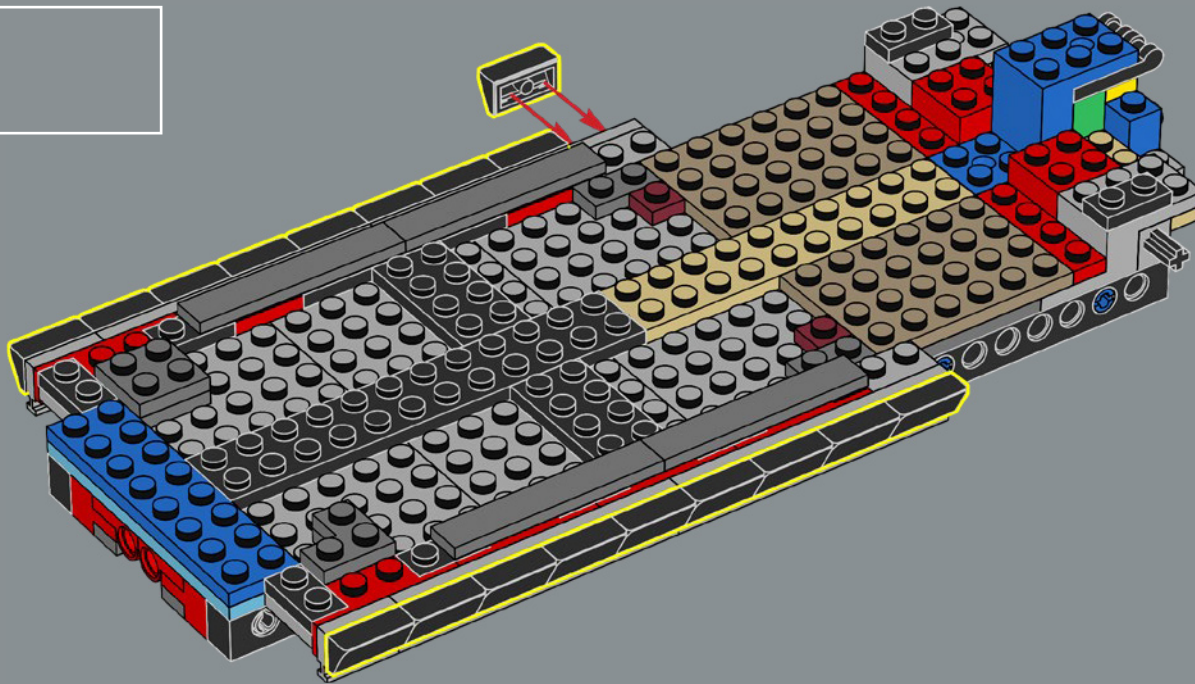

24

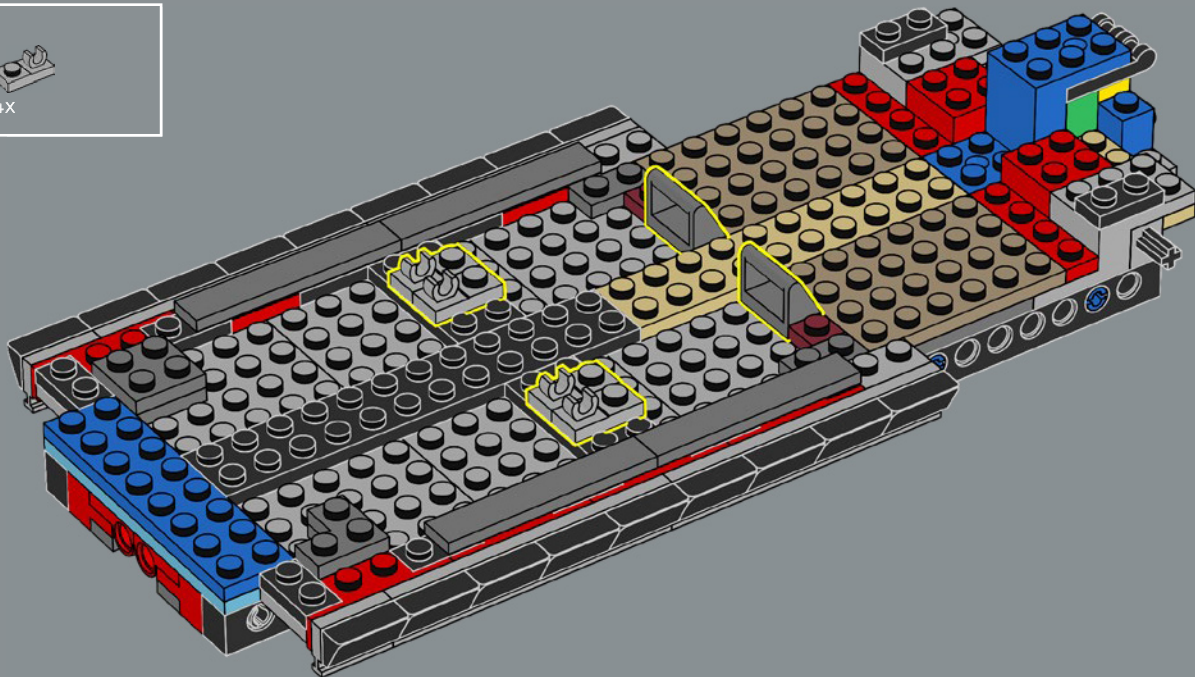



4x

25

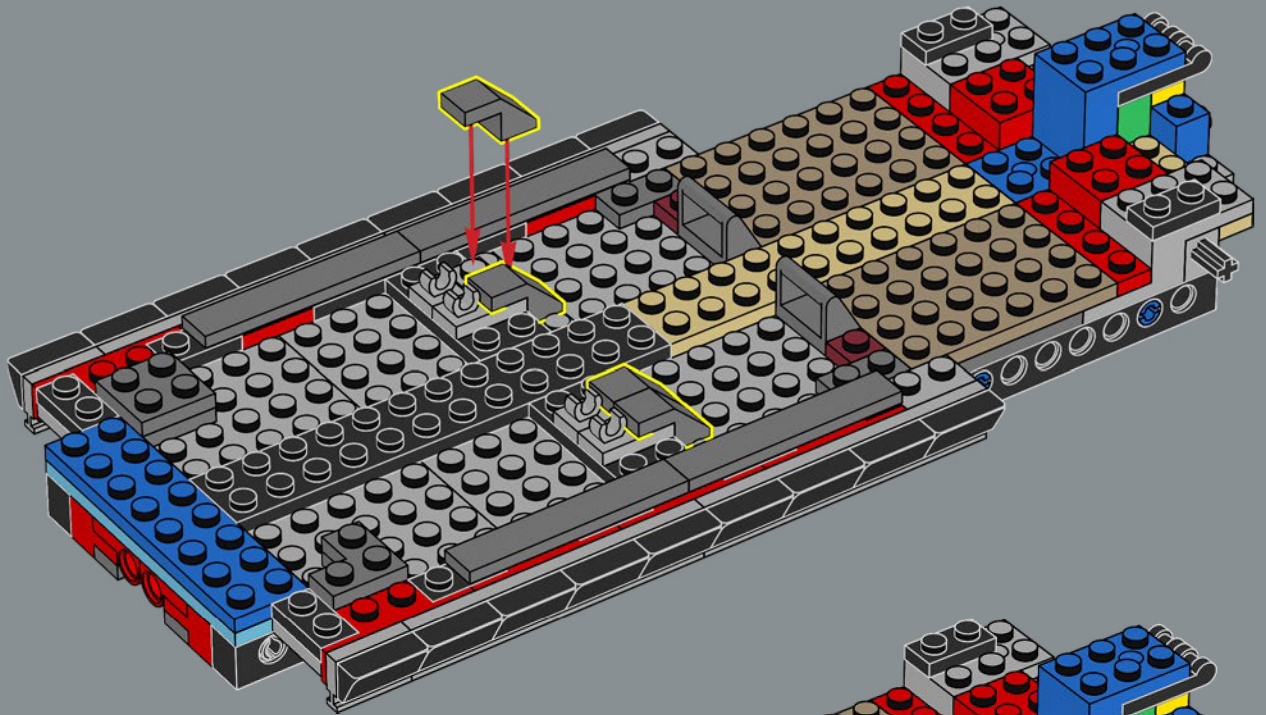

1x



1x



1x

26

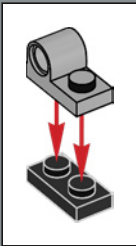
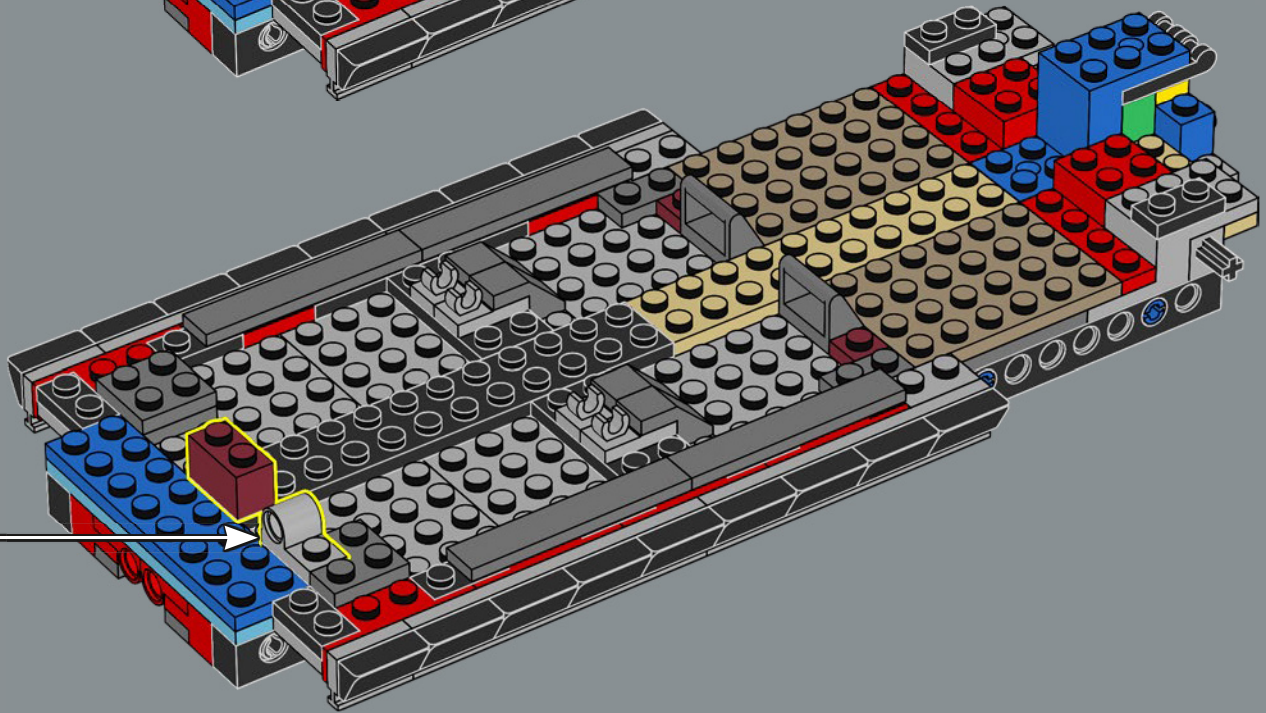

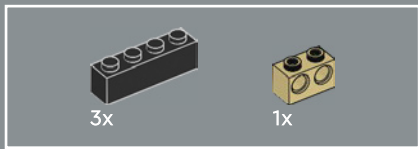

27

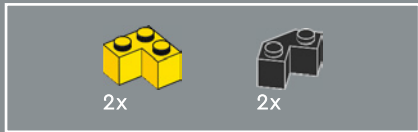
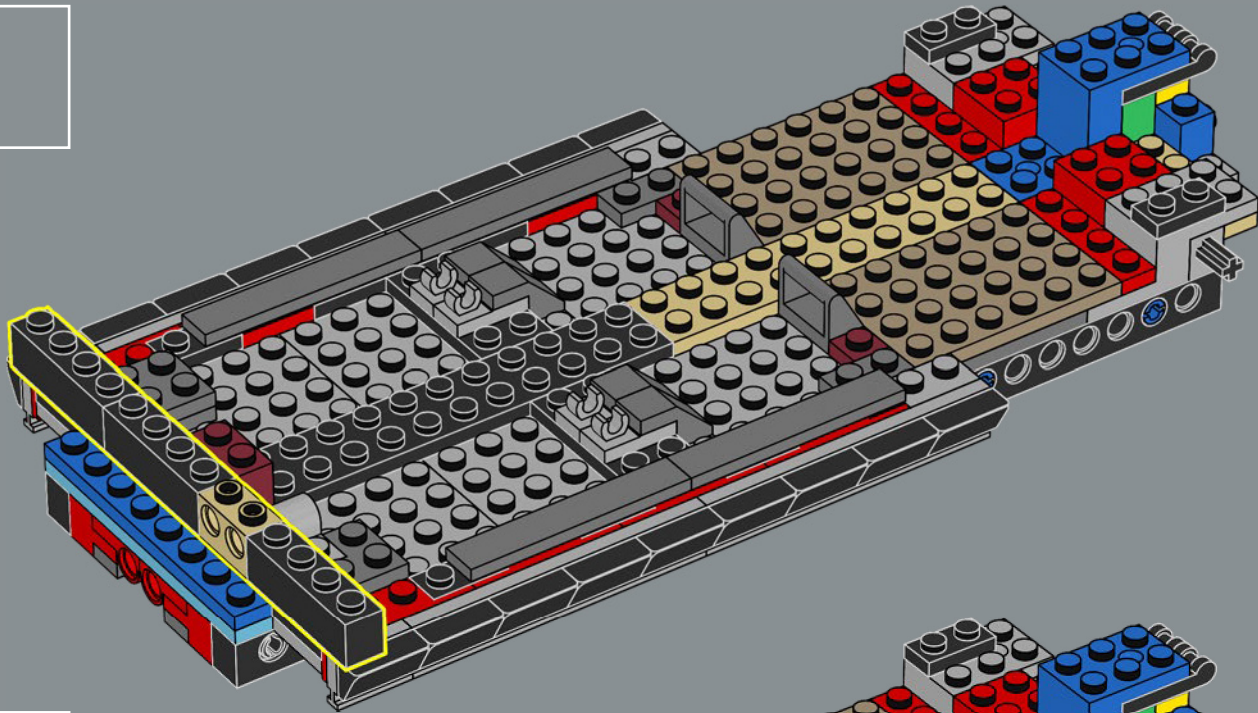

28

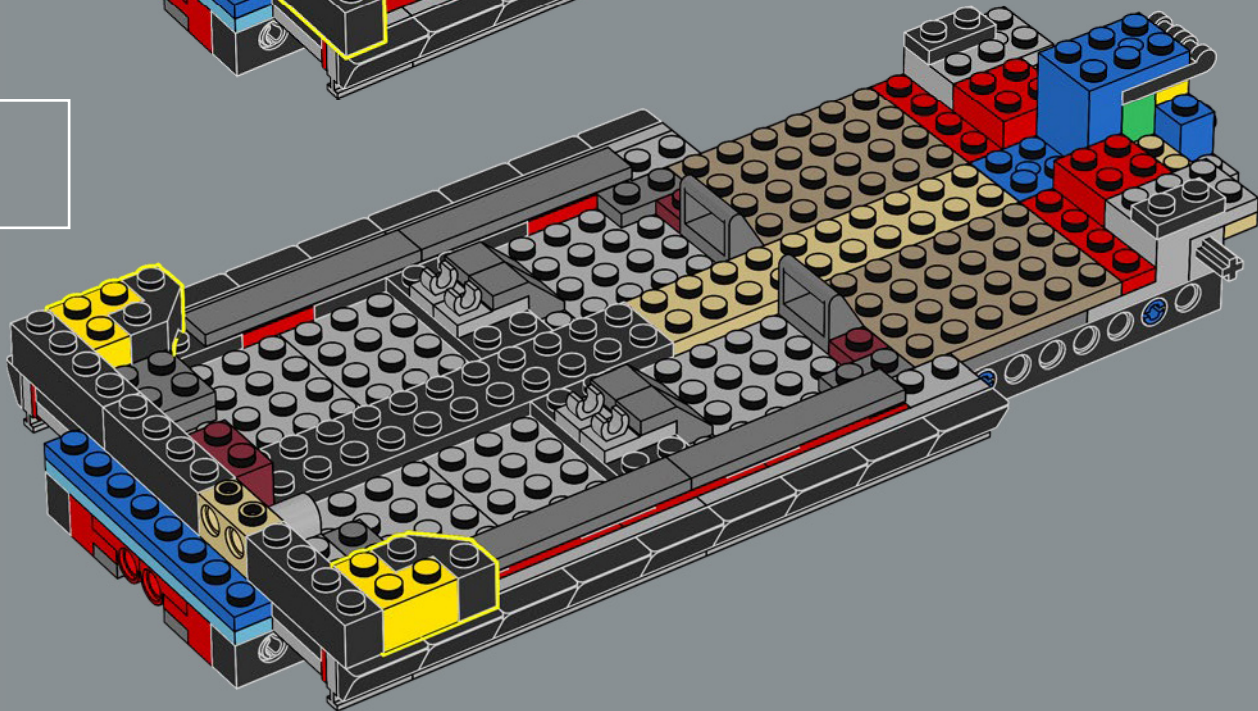



29

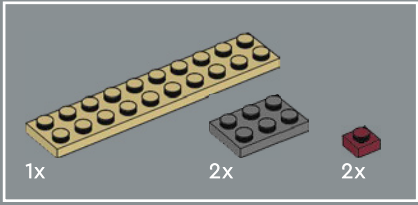
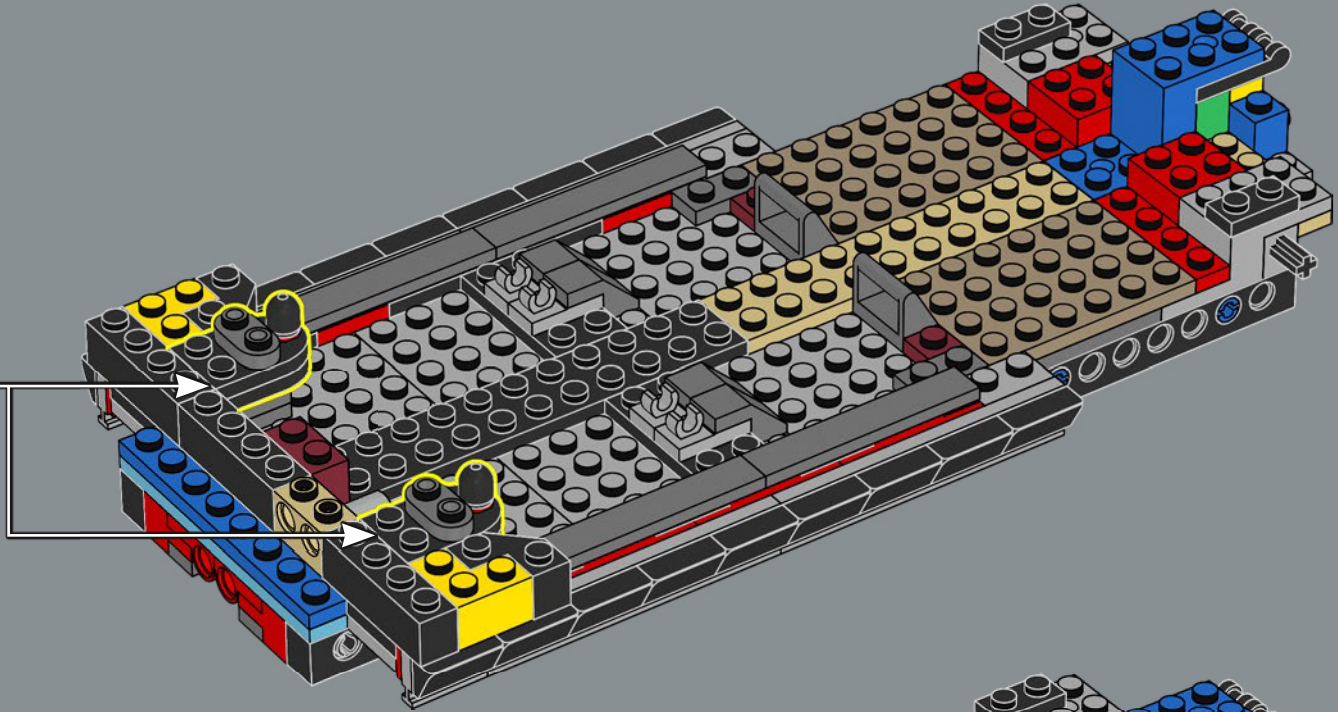
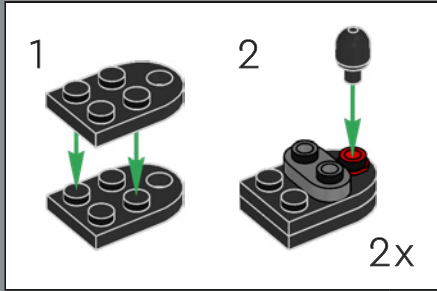

30

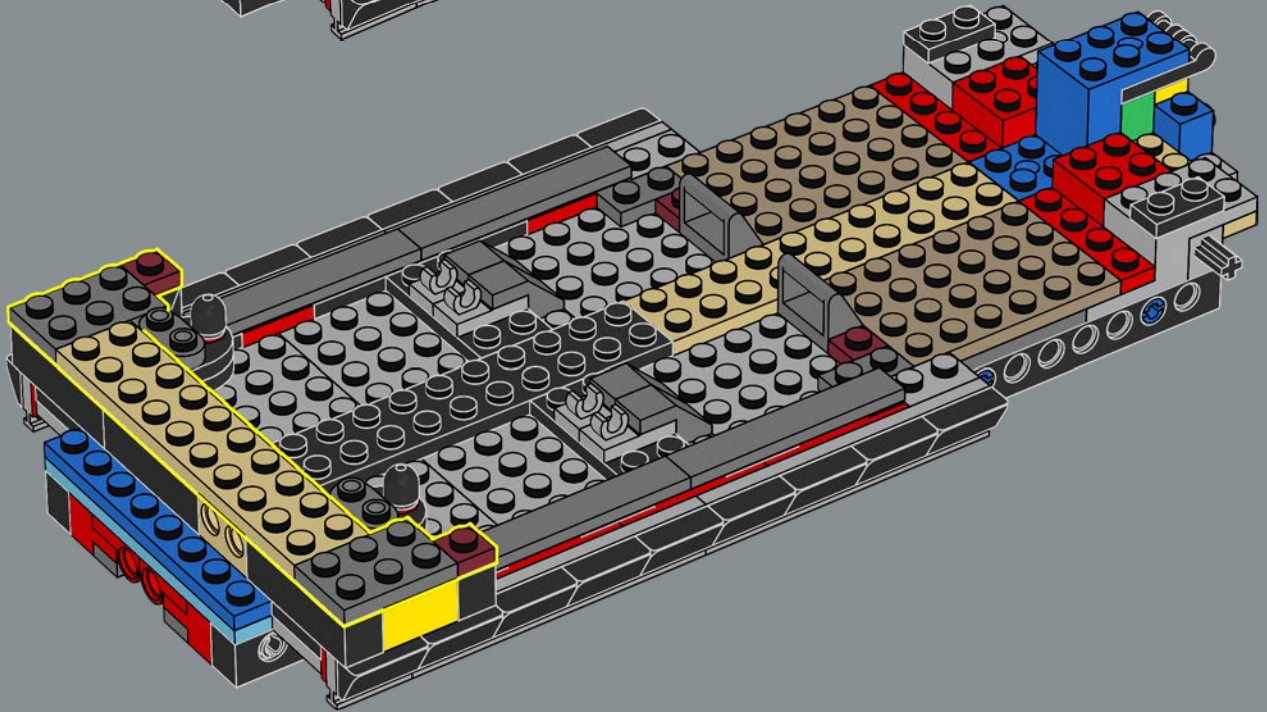

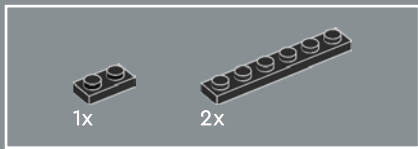

31

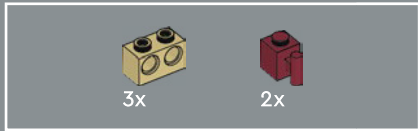
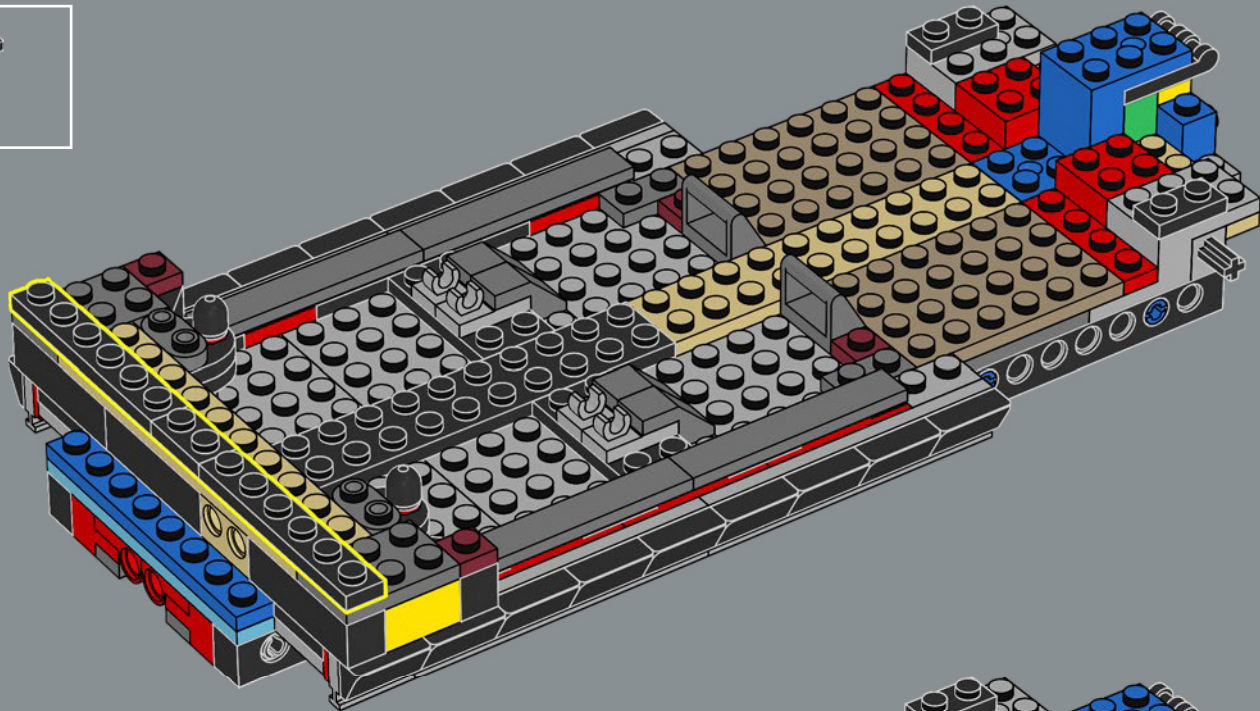

32

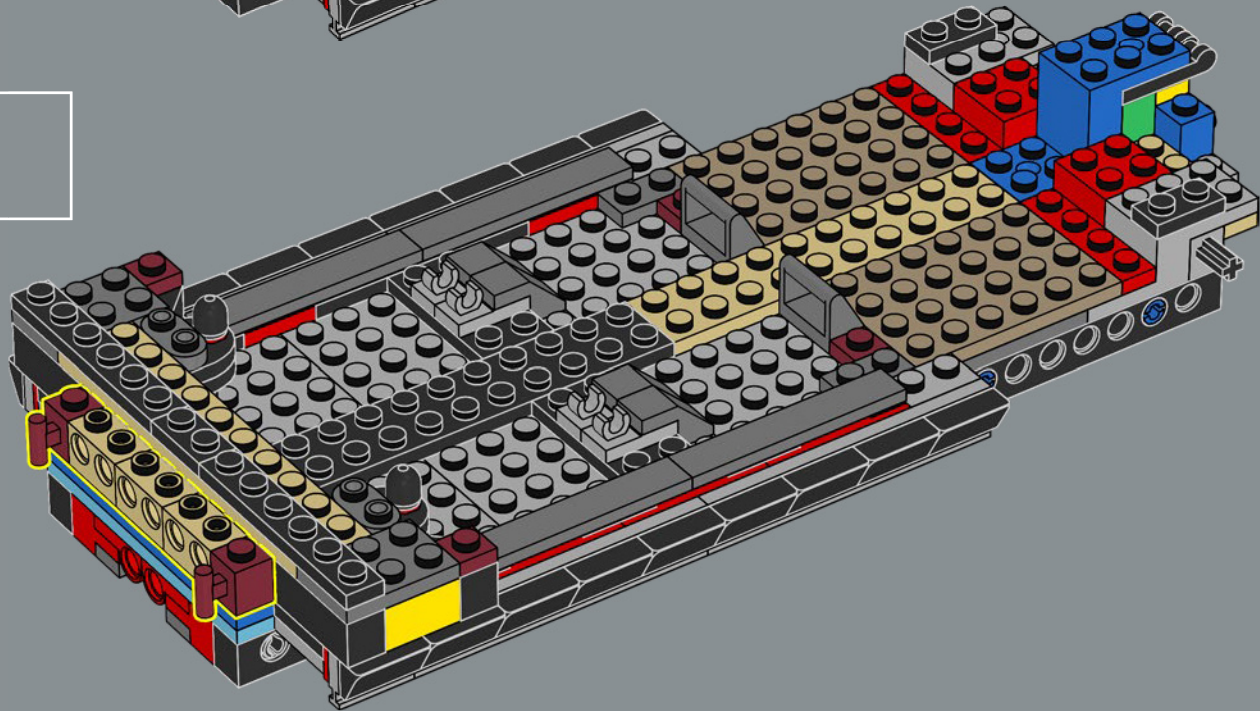

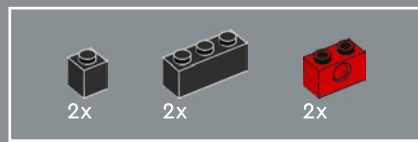

33

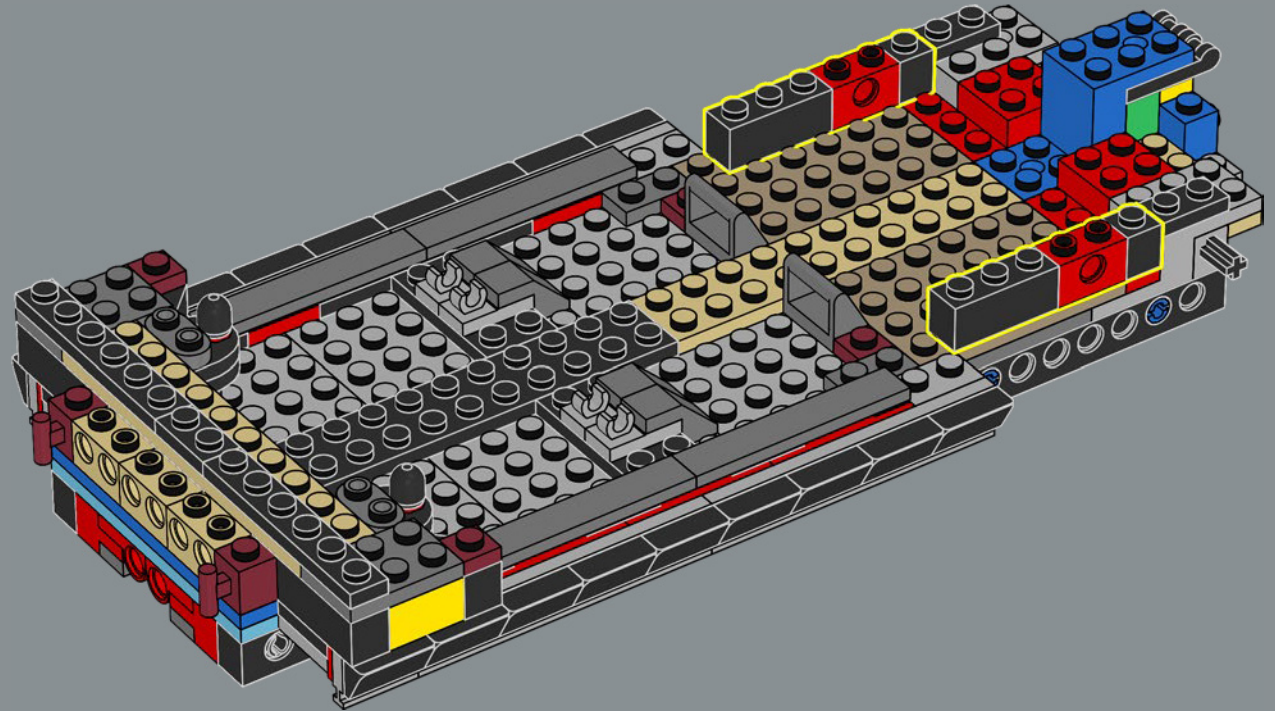

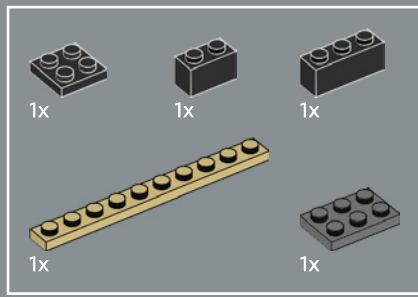

34

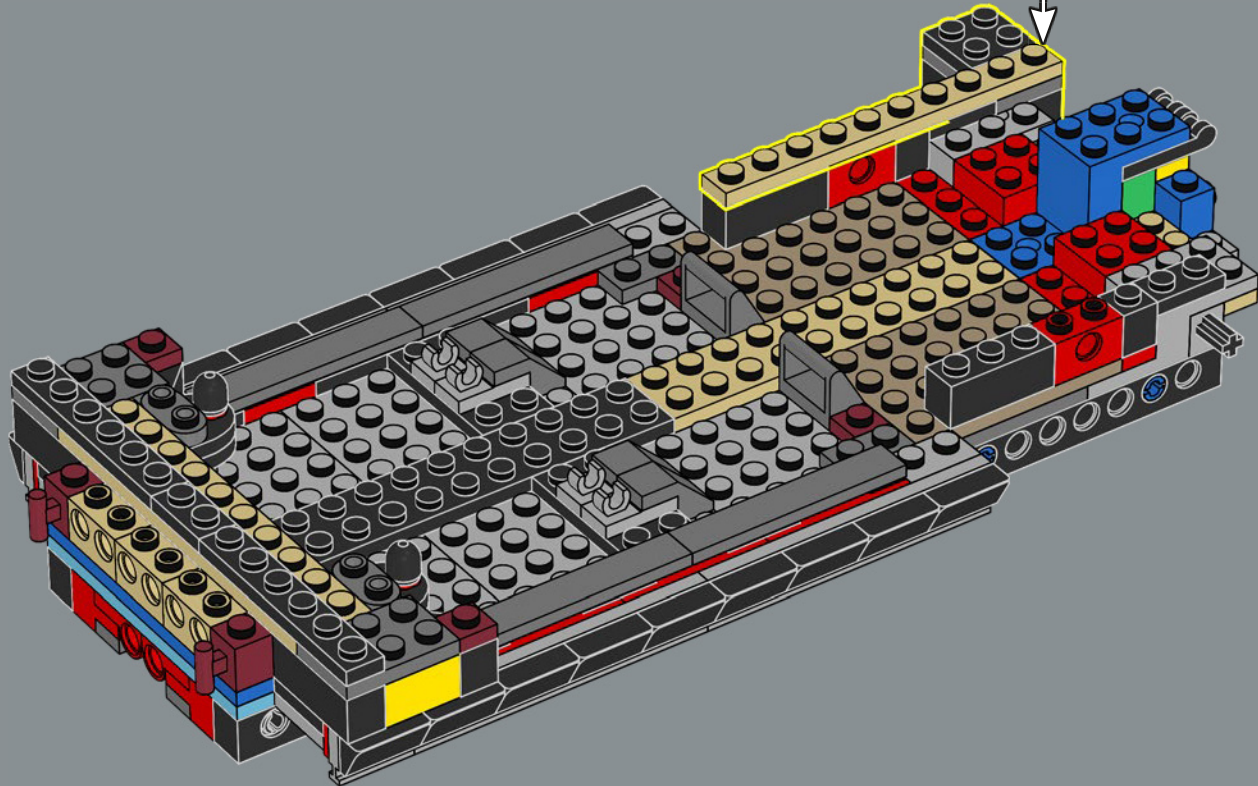
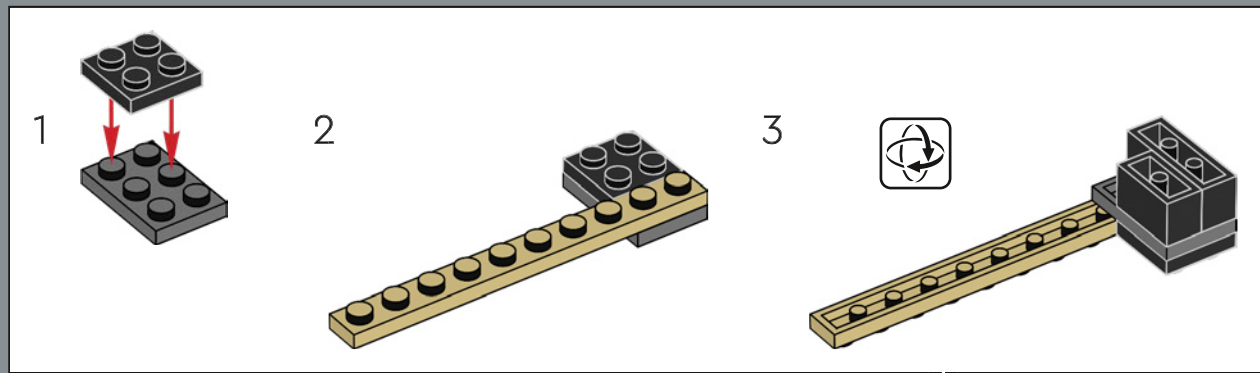

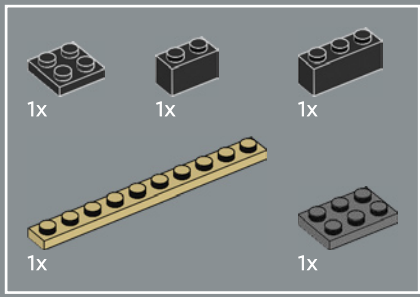

35

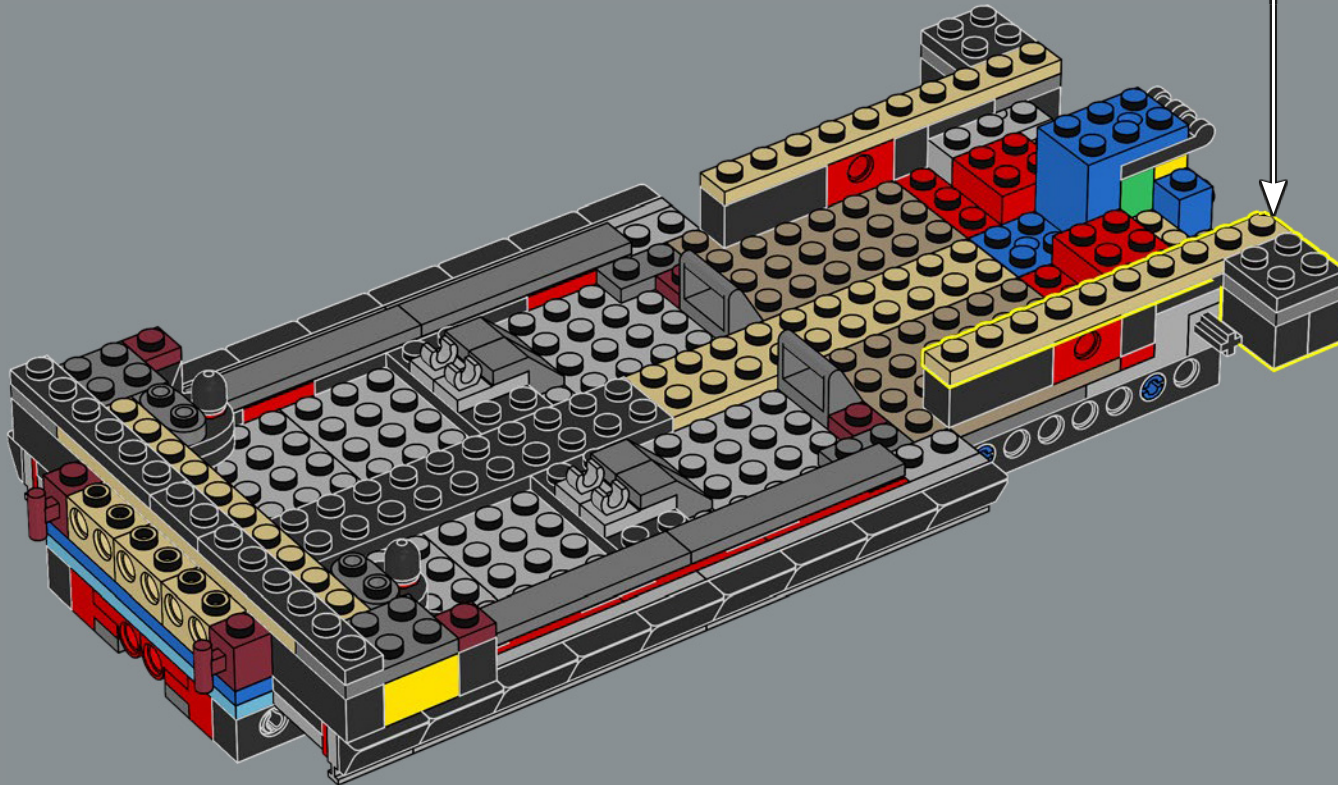
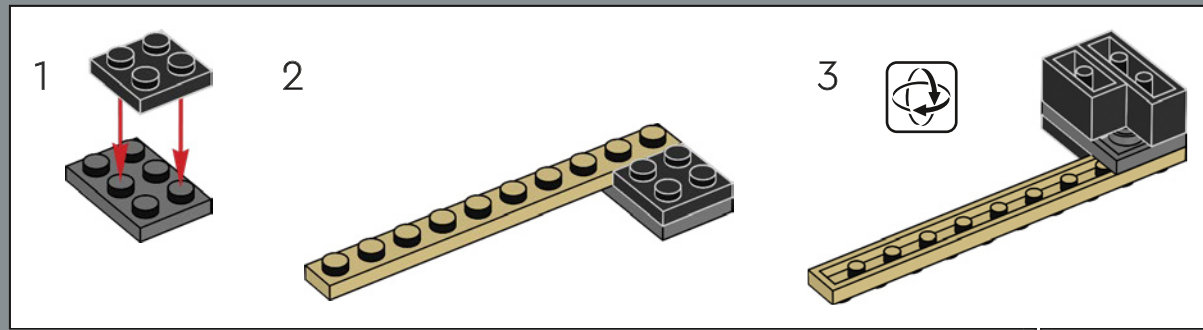

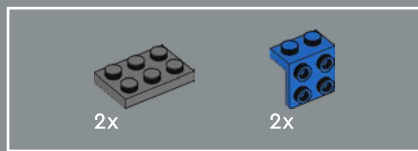

36

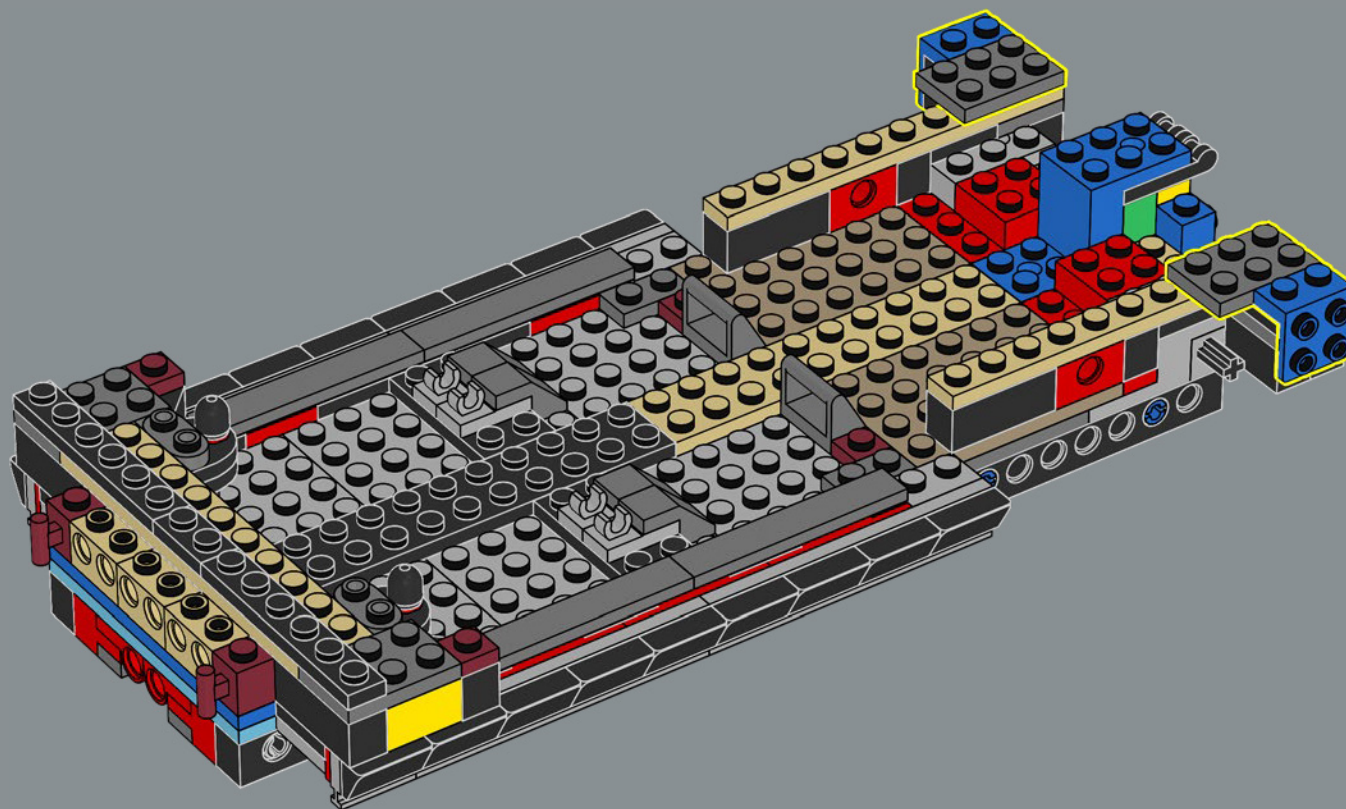

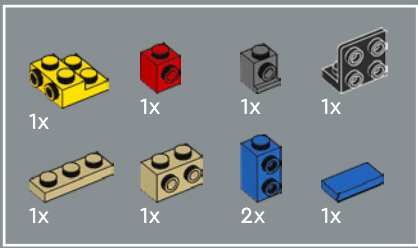

37

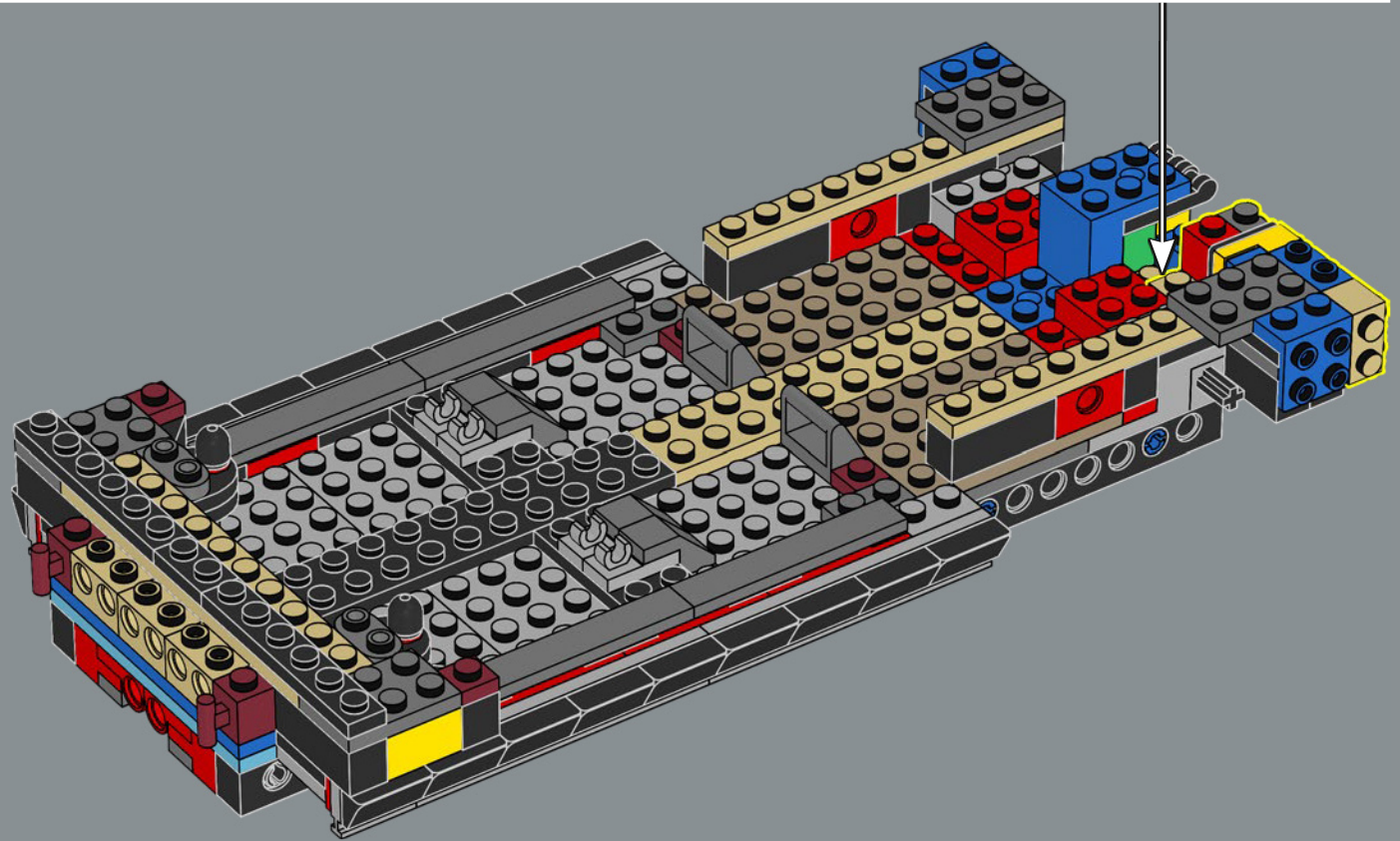
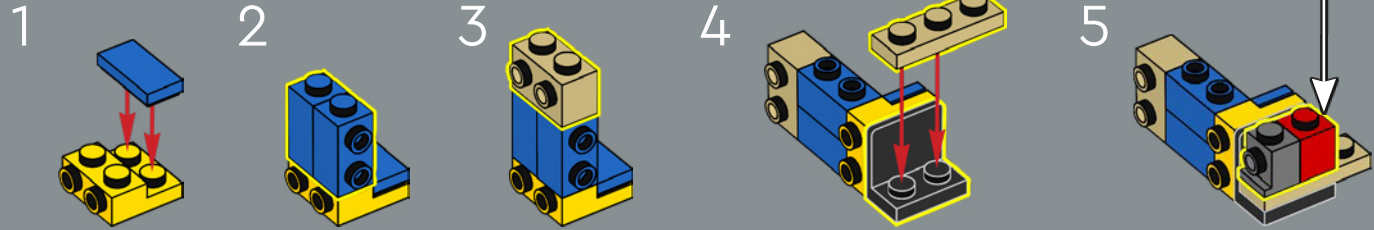

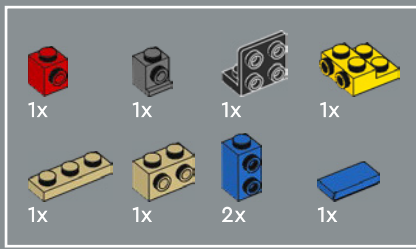

38

1

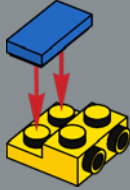

2

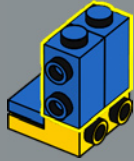

3



4

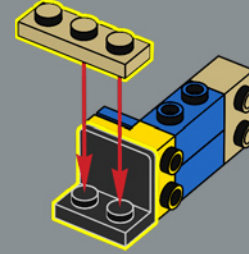

5

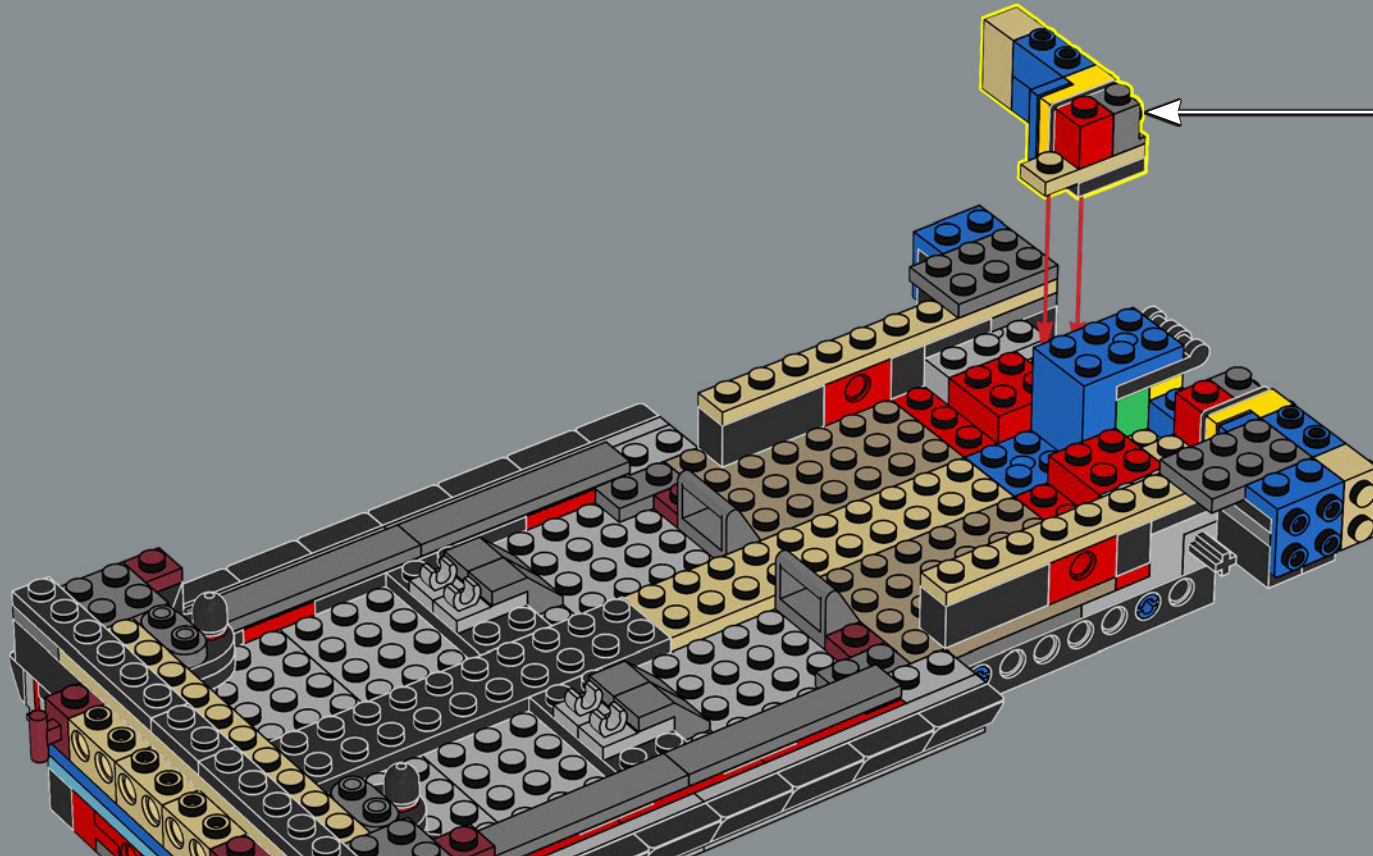
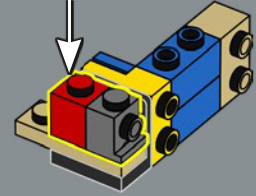
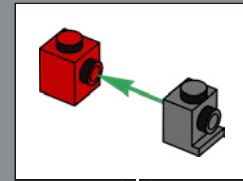

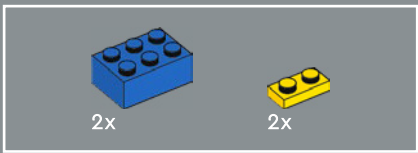

39

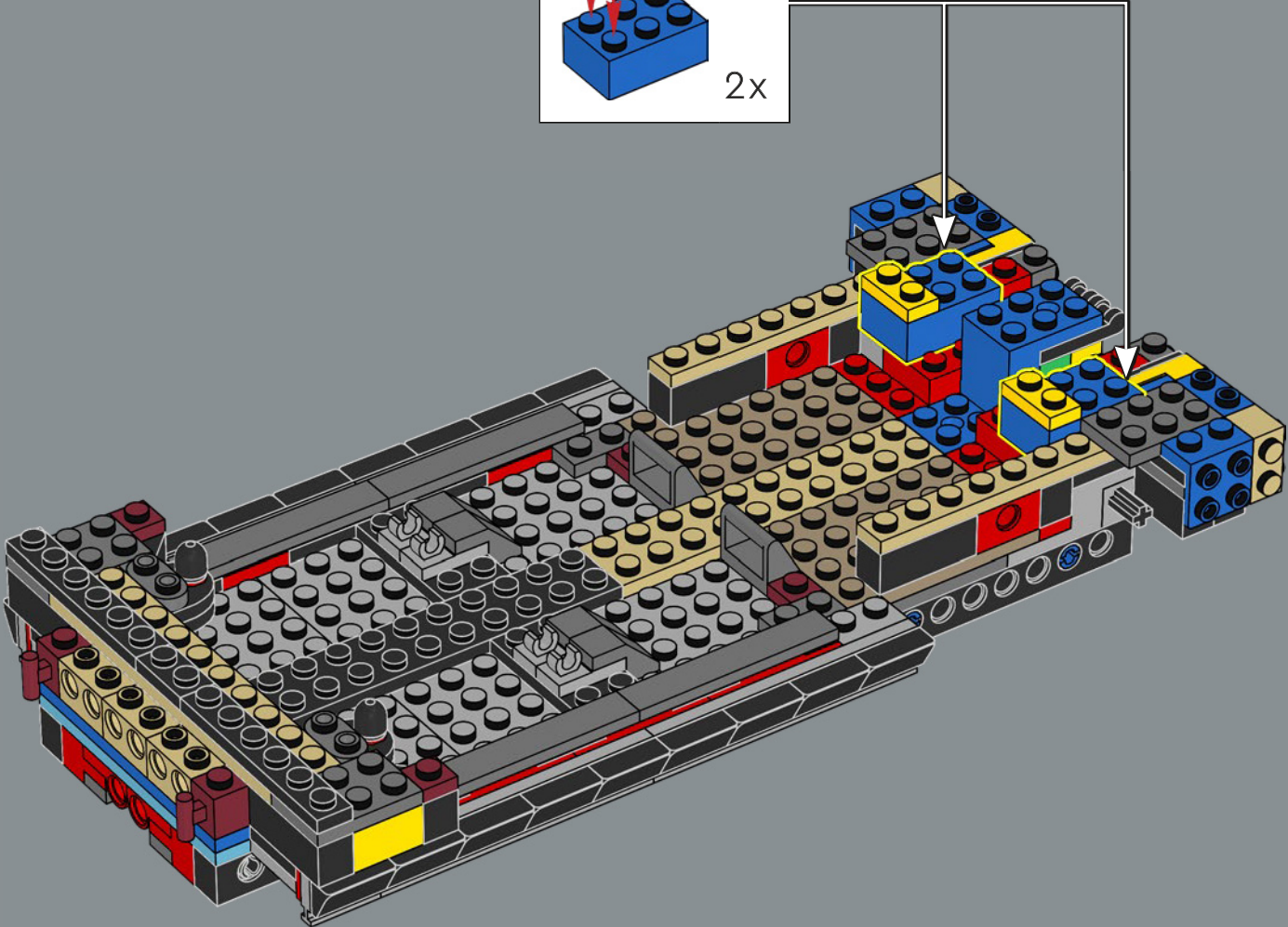
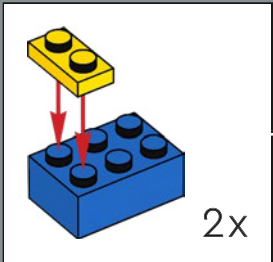

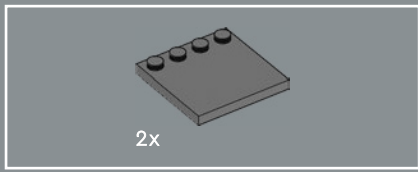

40

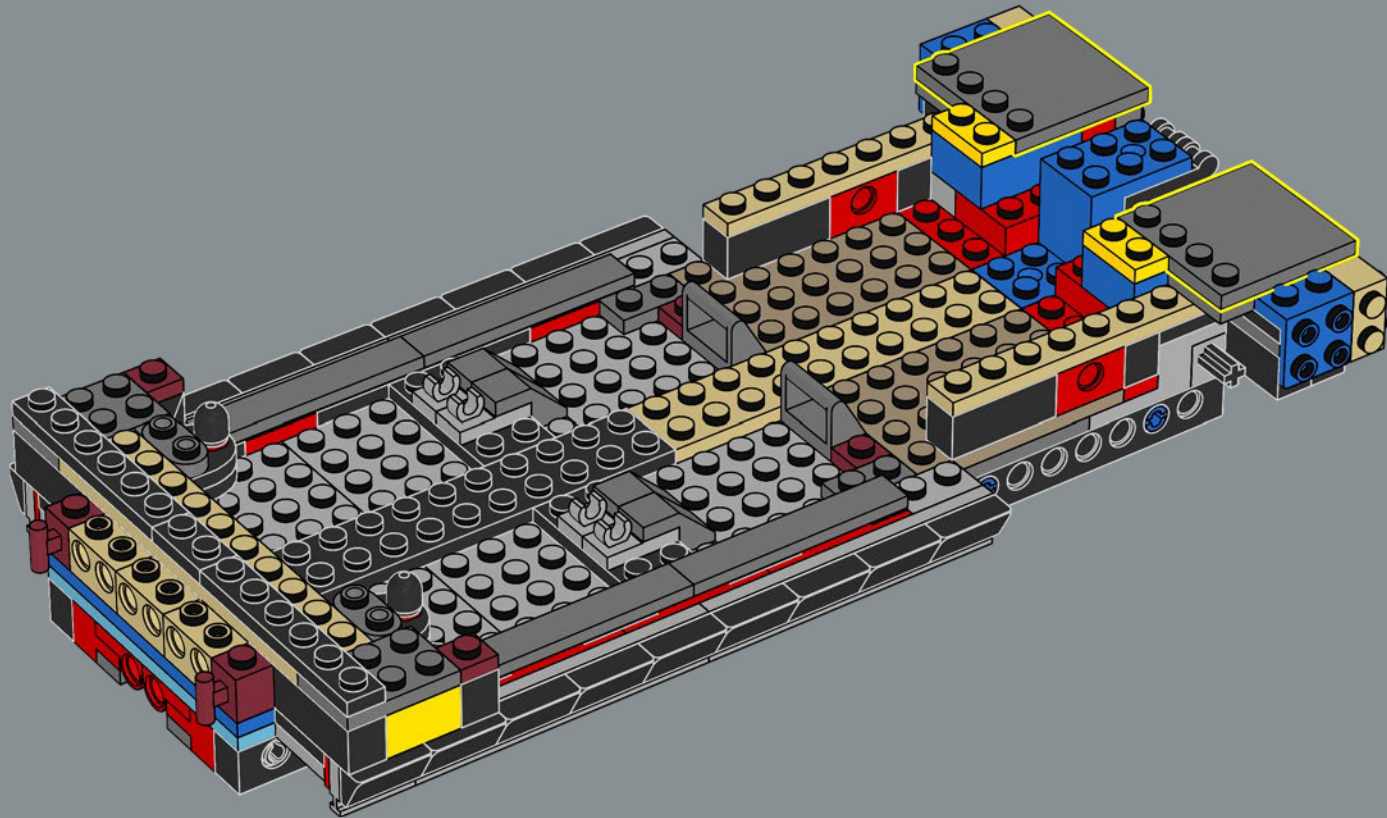



41

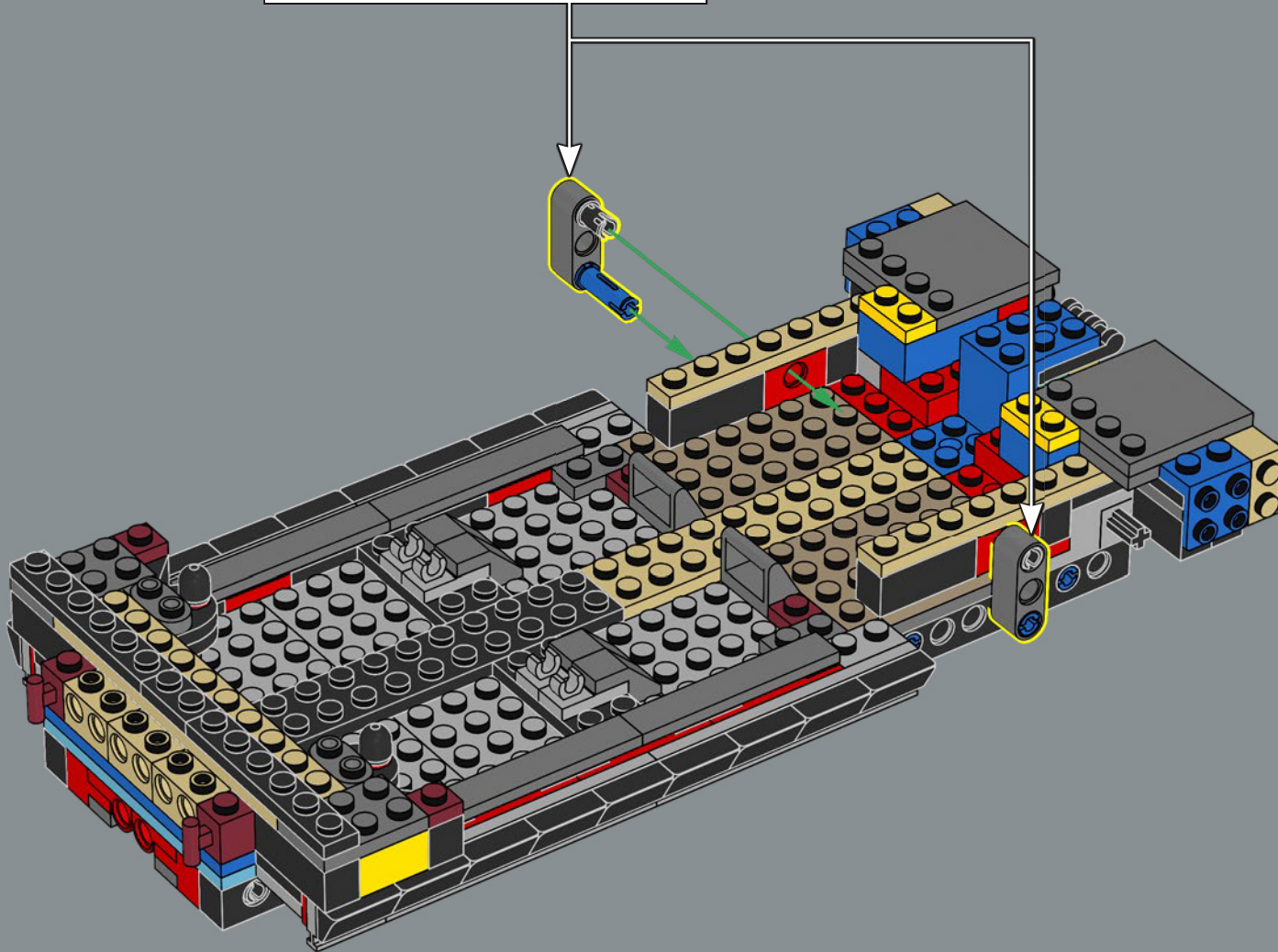
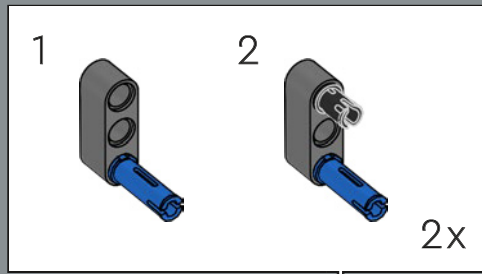

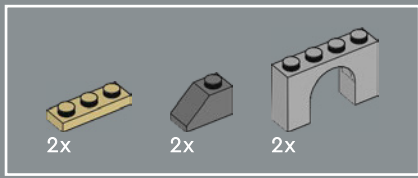

42

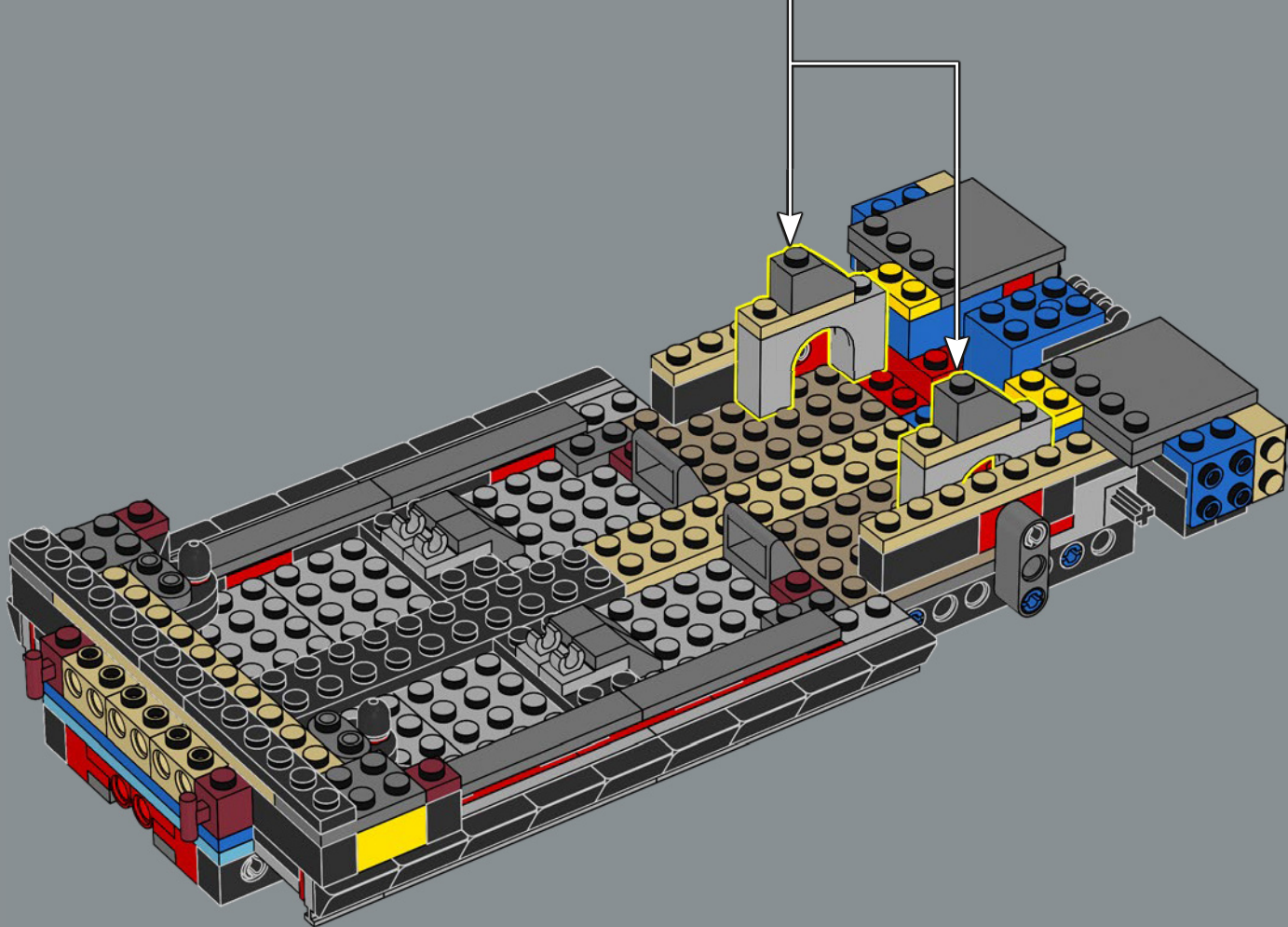
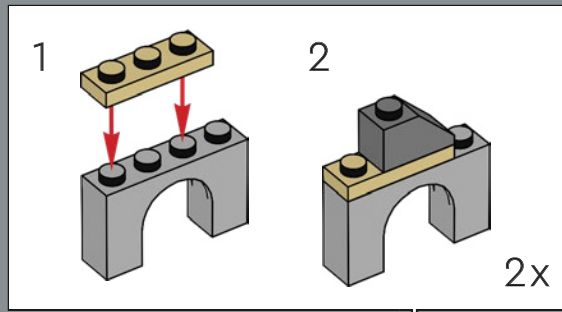

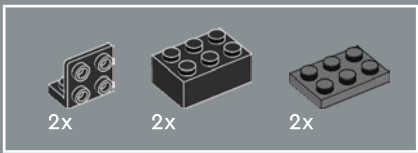

43

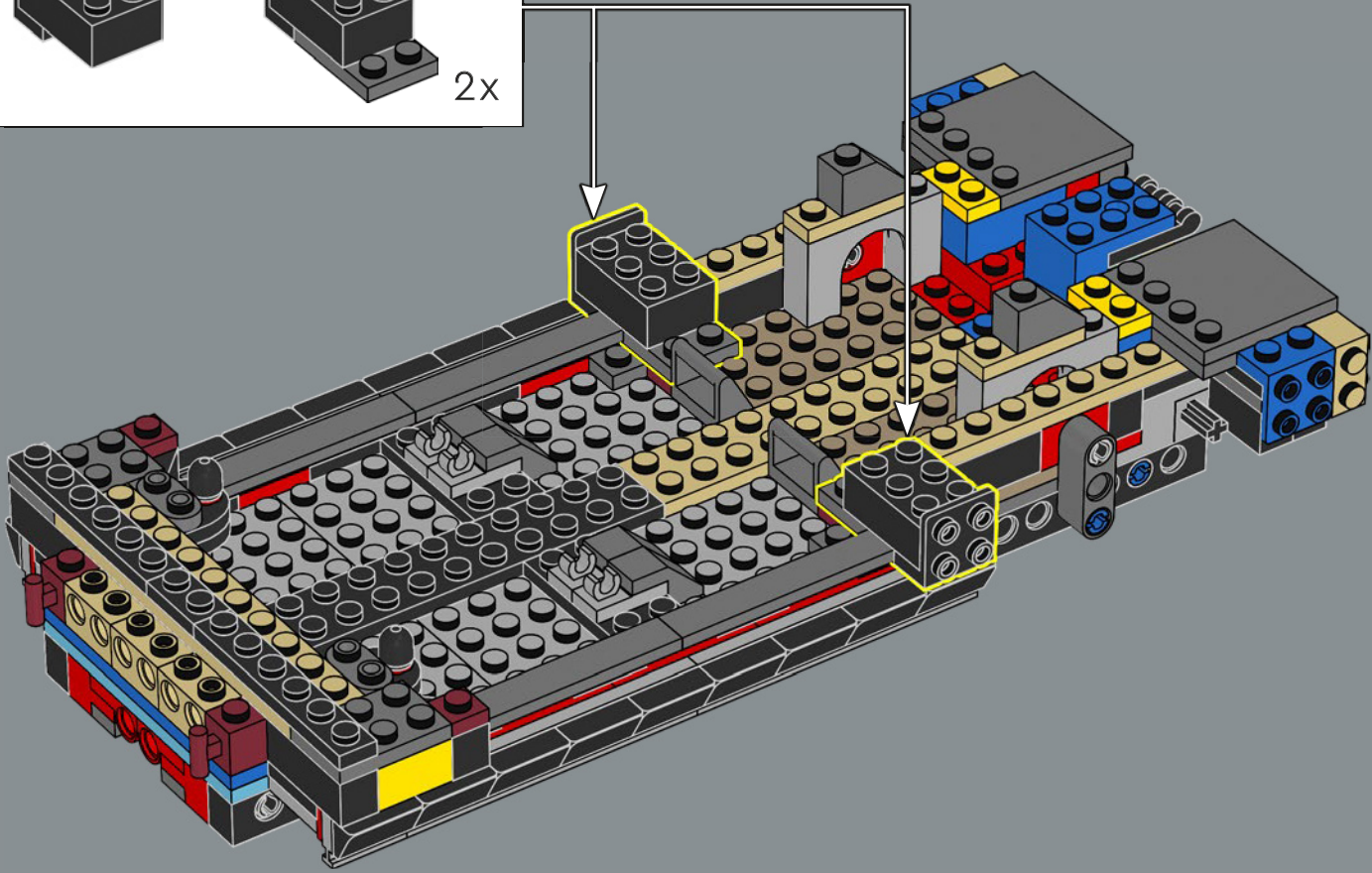
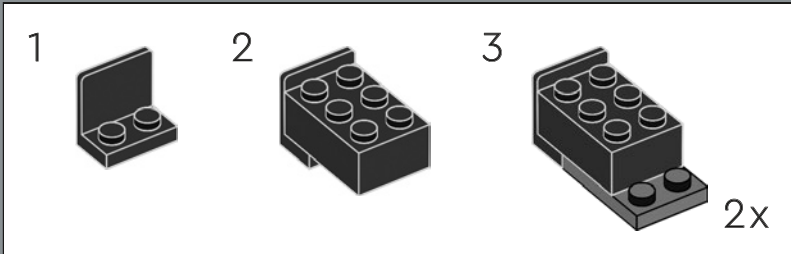

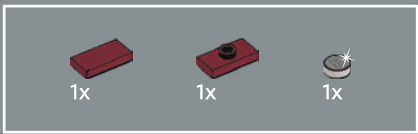

45

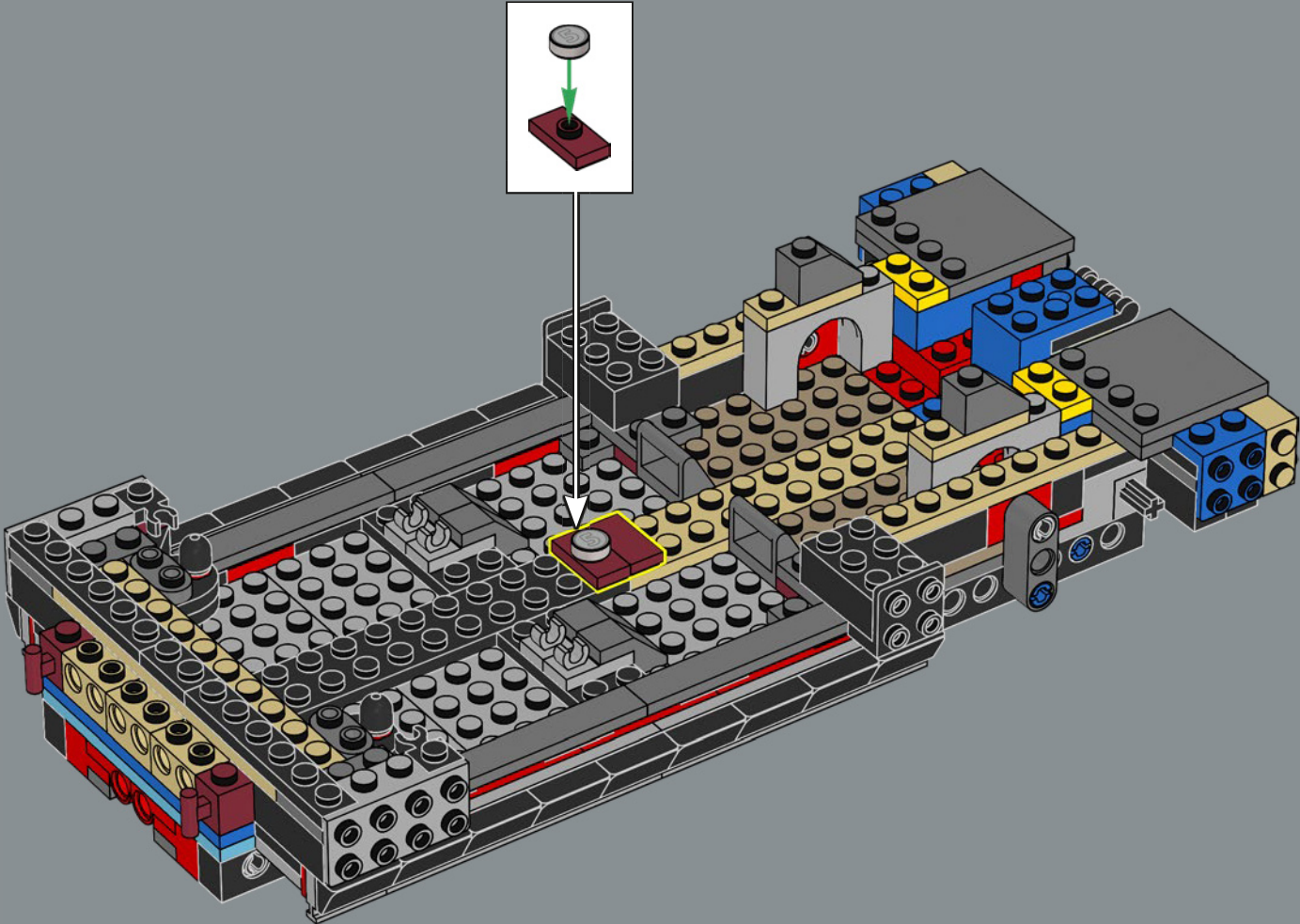

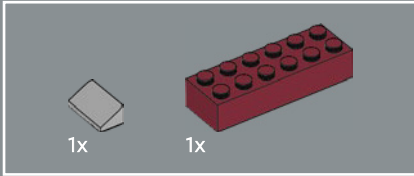
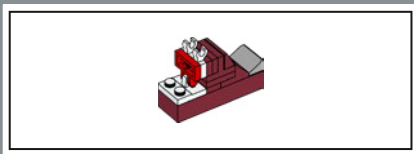

46

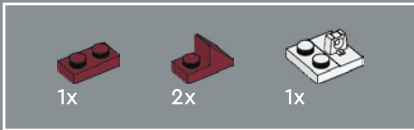
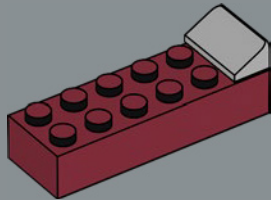

47

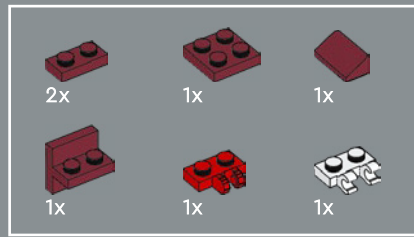
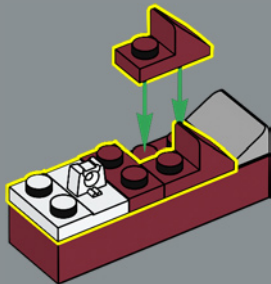

48

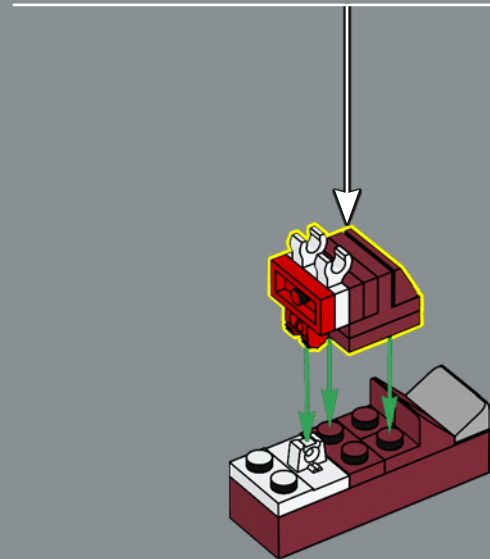
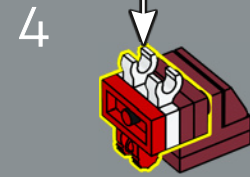
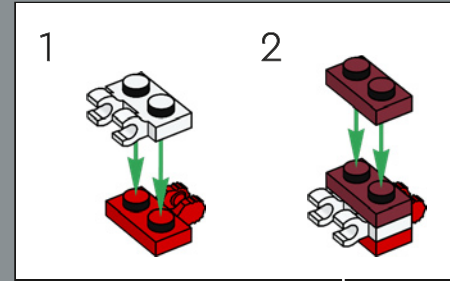
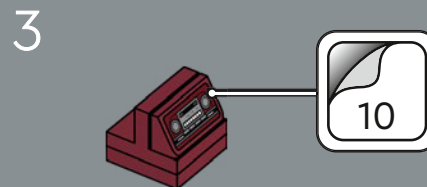
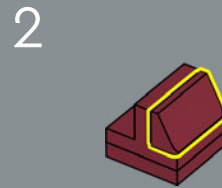
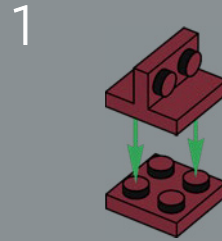

Le premier prototype de la Camaro,
le châssis n° 10001, existe toujours
et est inscrit au Registre national
des véhicules historiques.

49

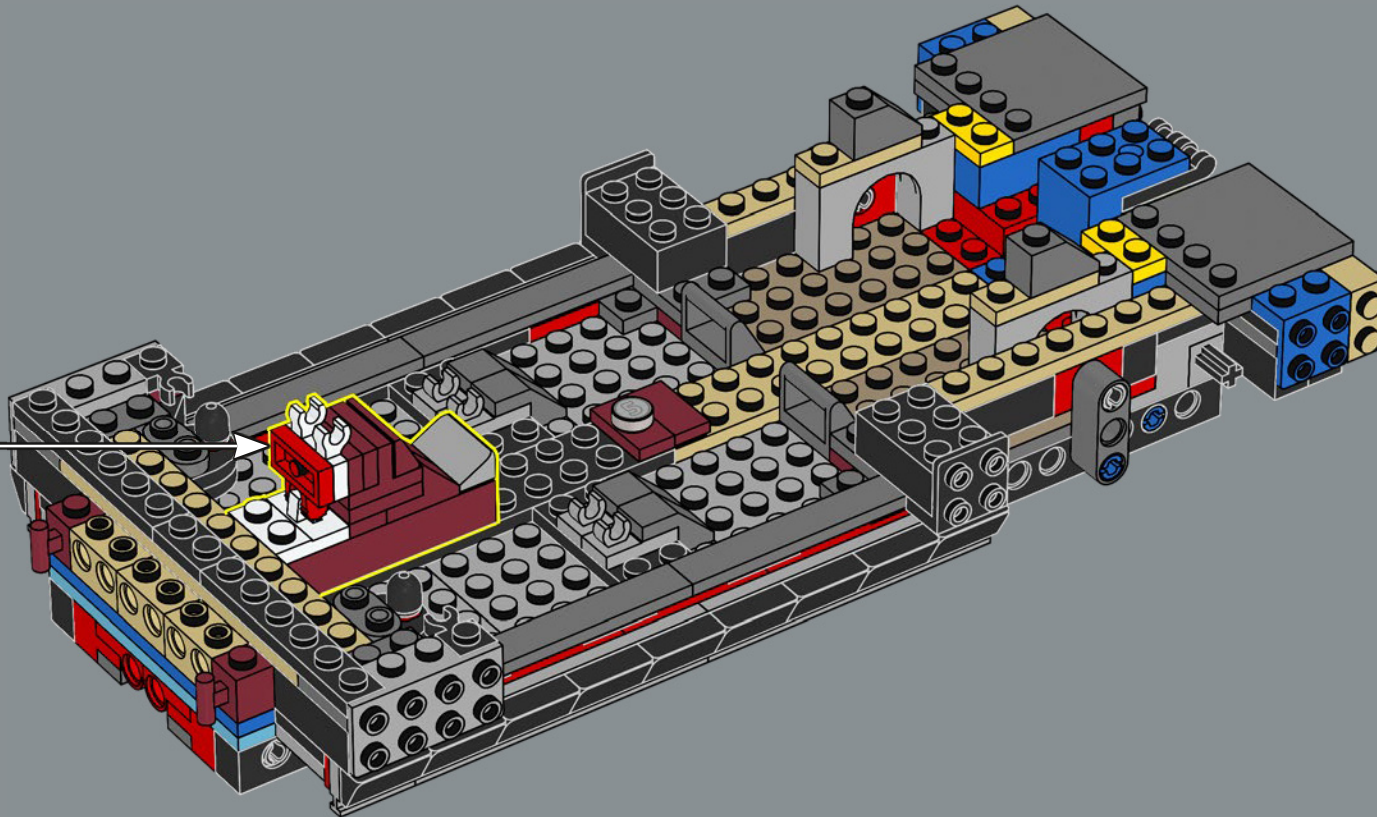

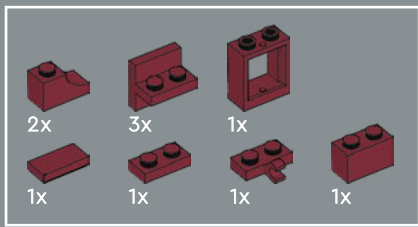

50

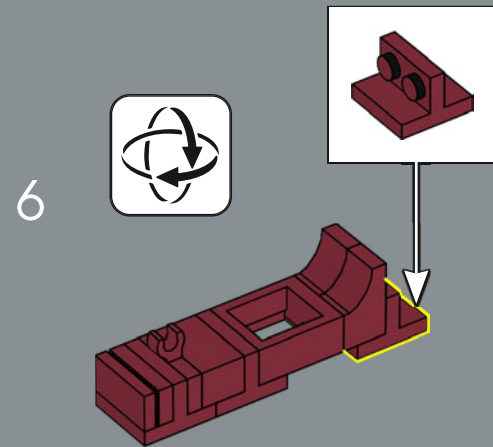
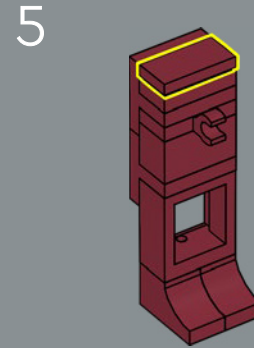
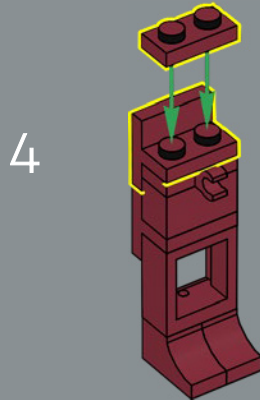
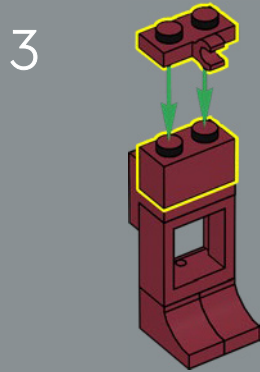
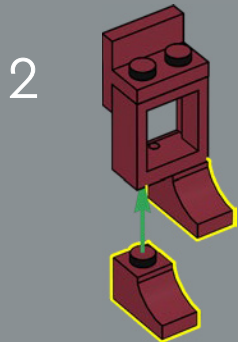
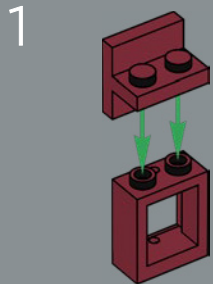

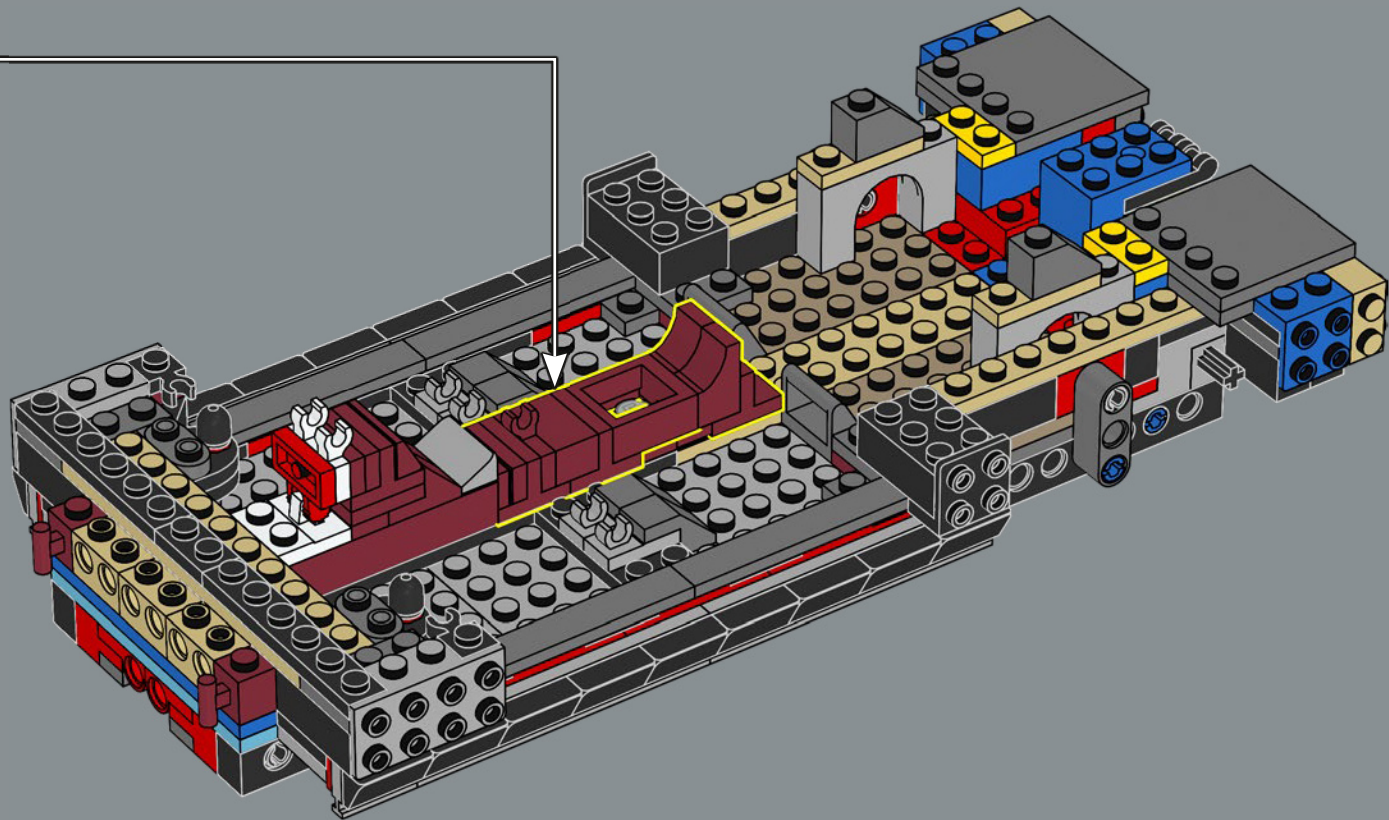

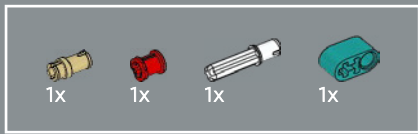

51

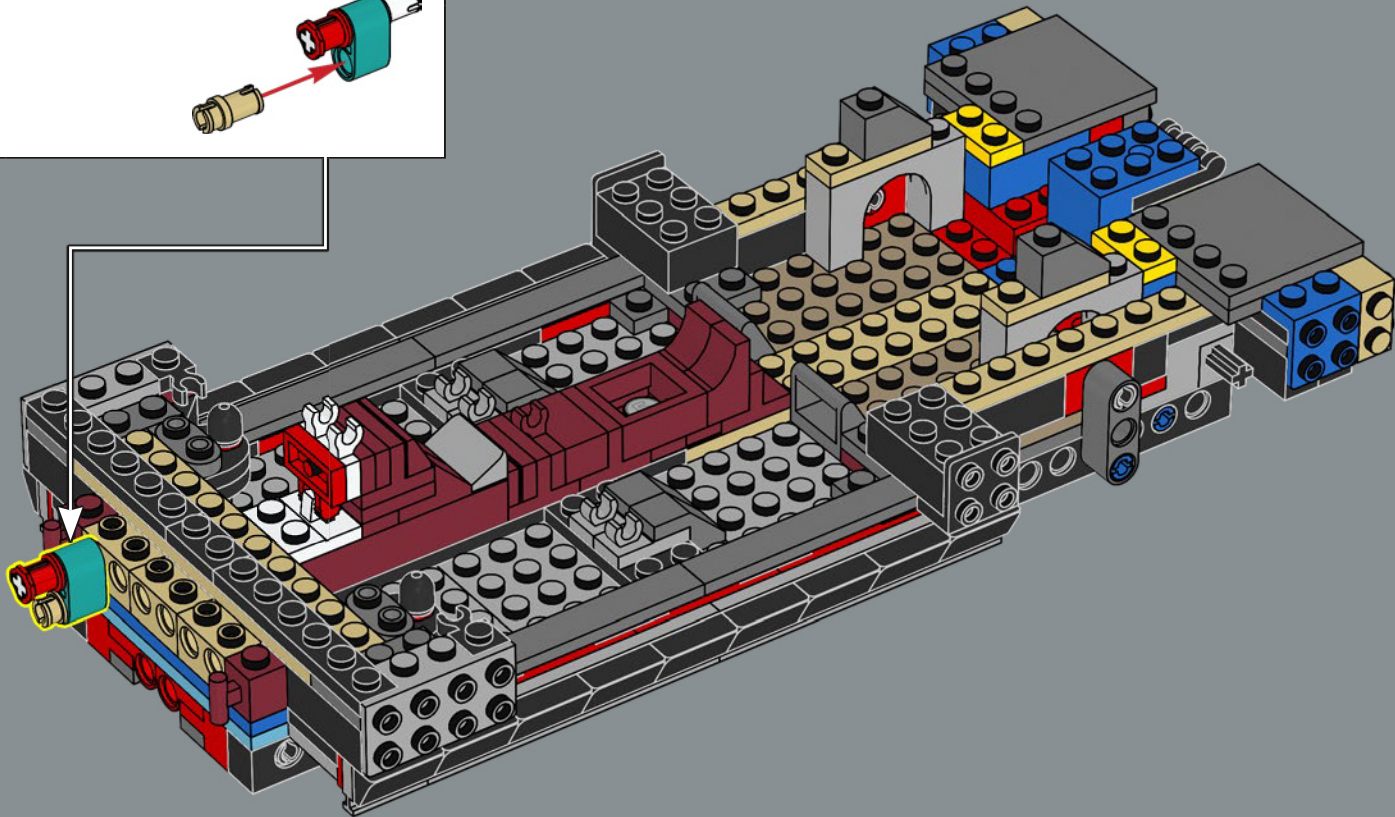
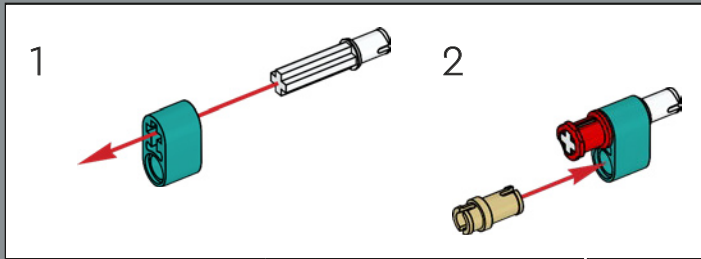

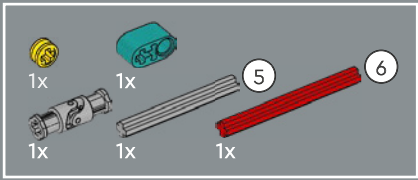

52

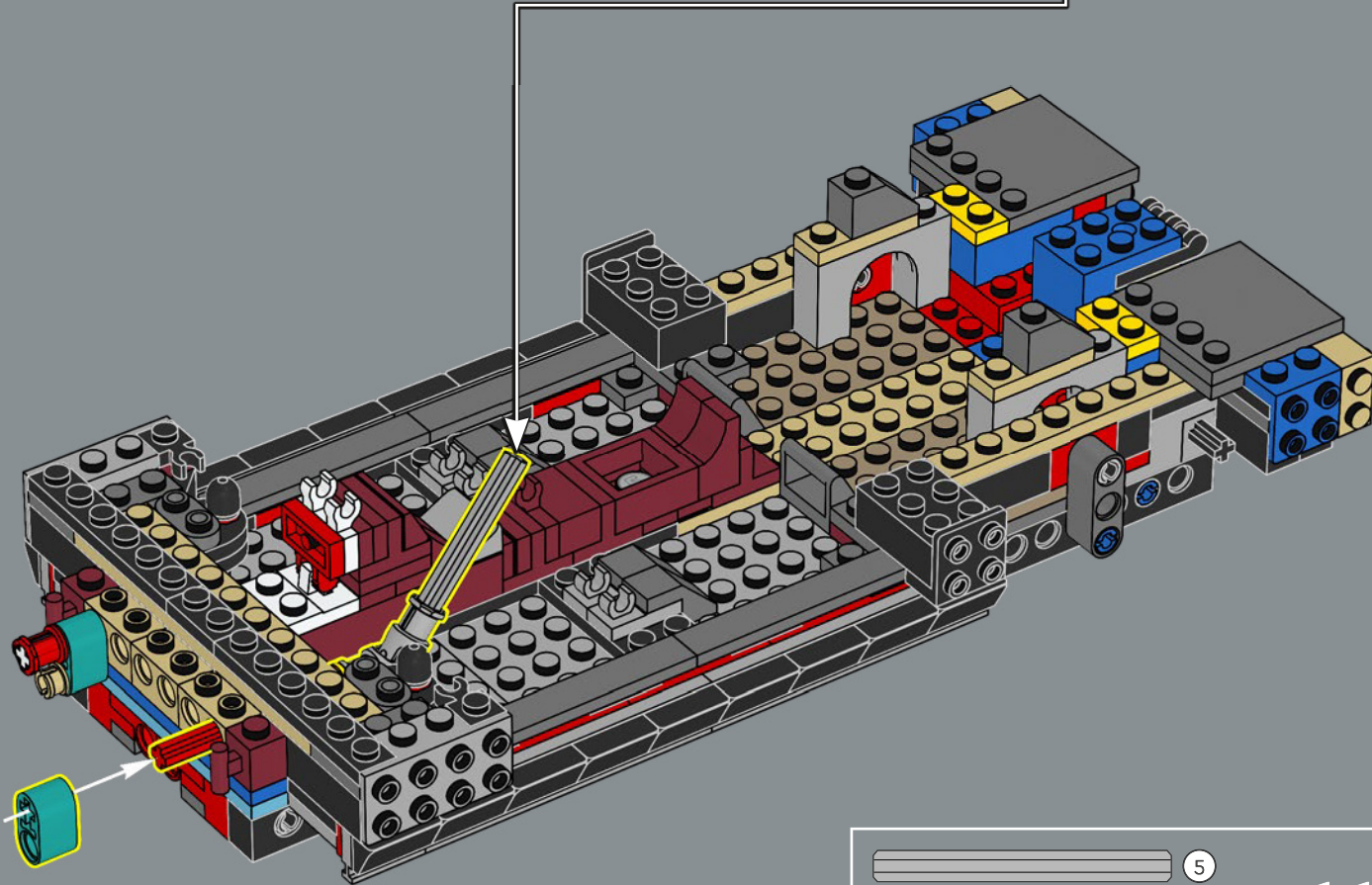
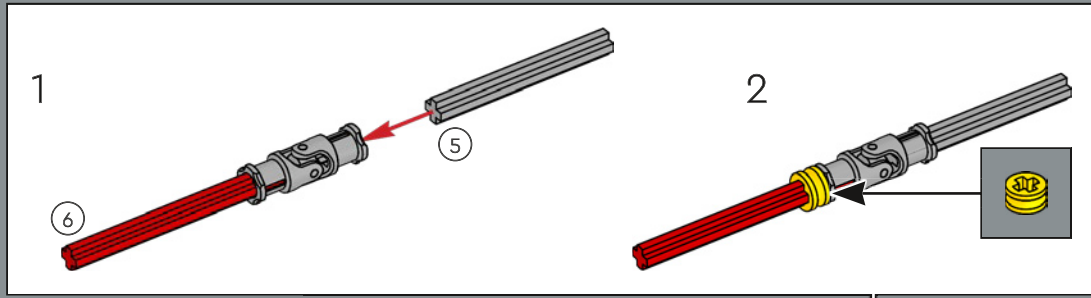



53

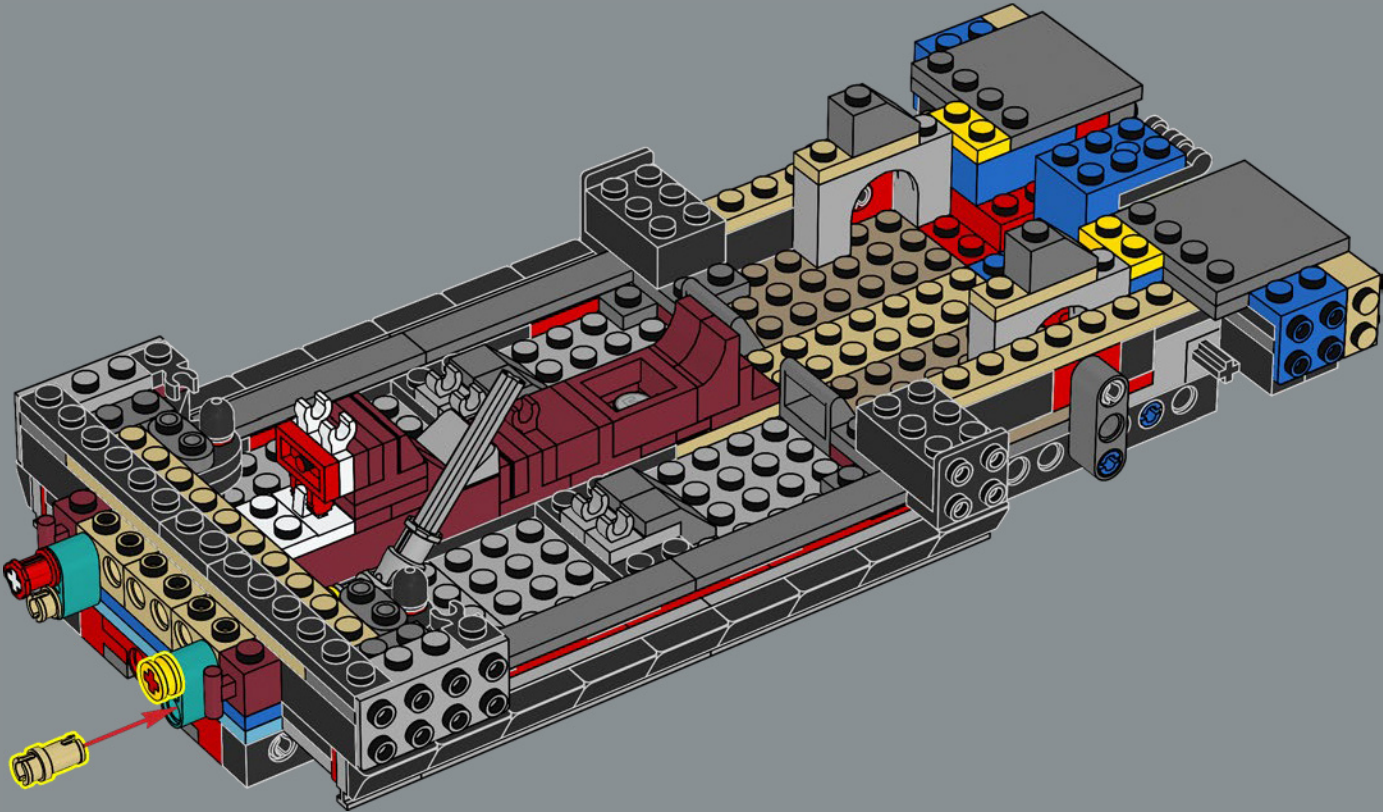

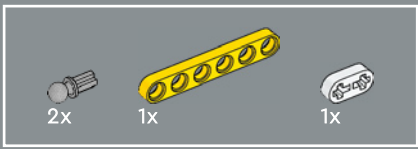

54

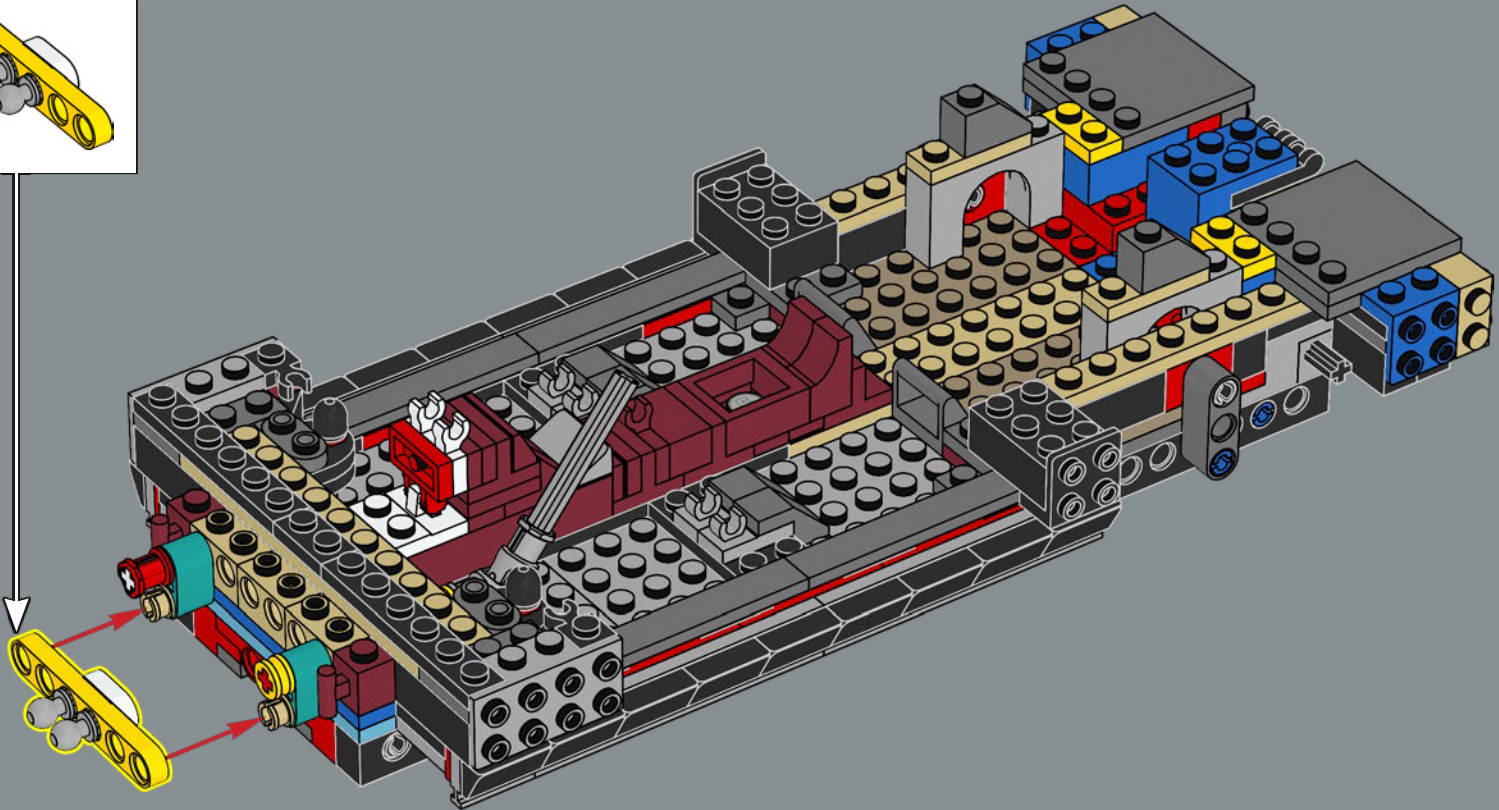
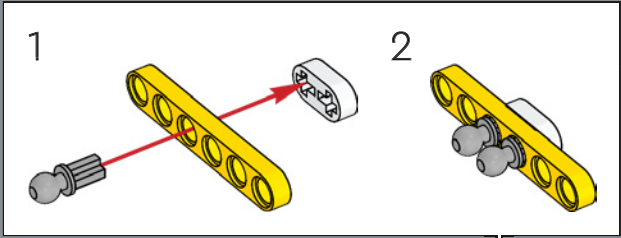

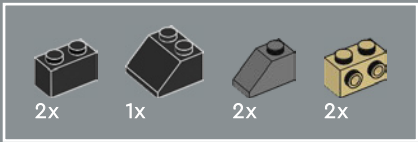

55

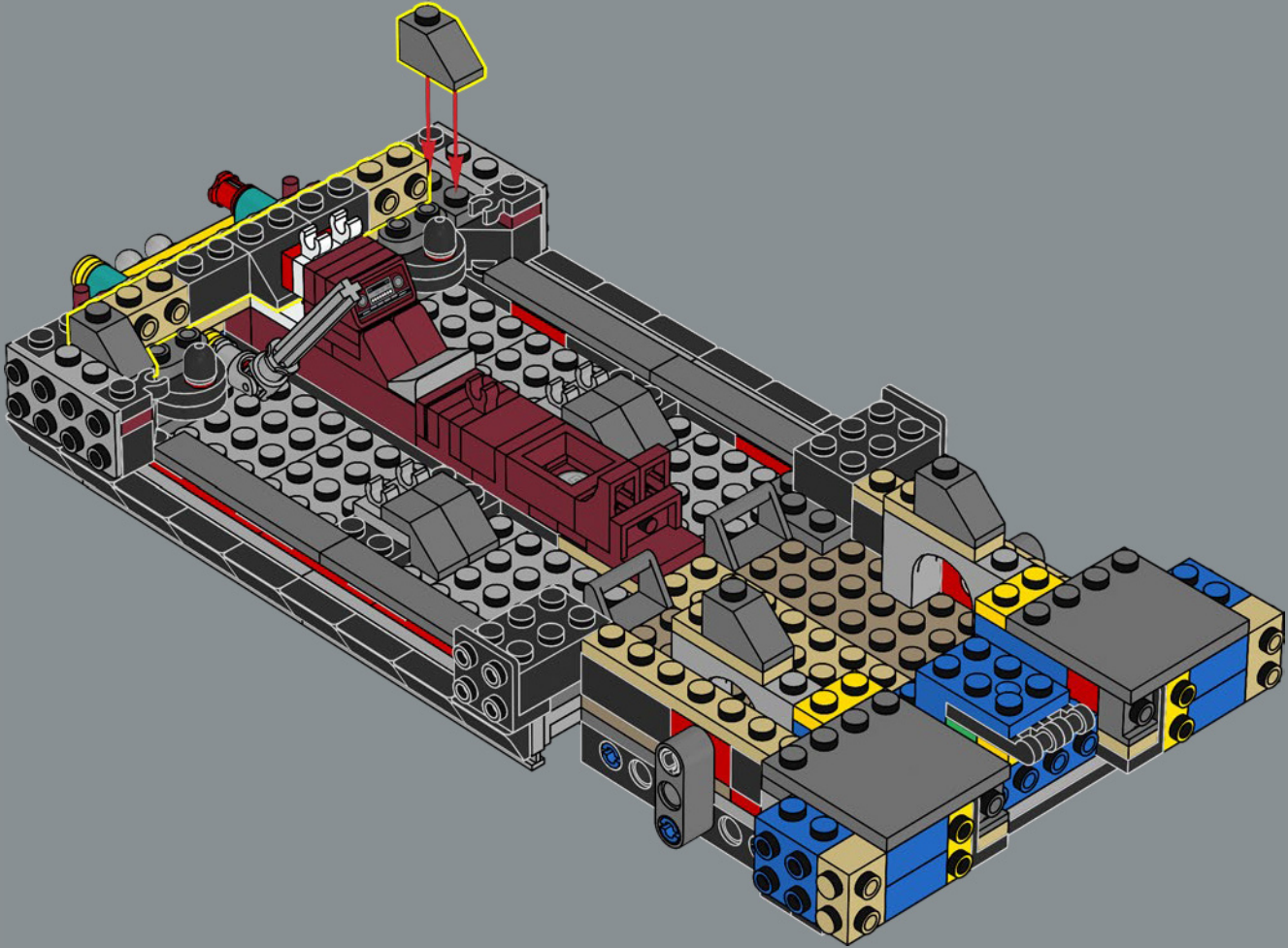

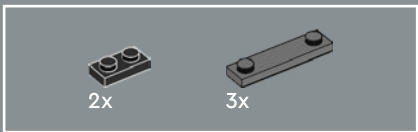

56

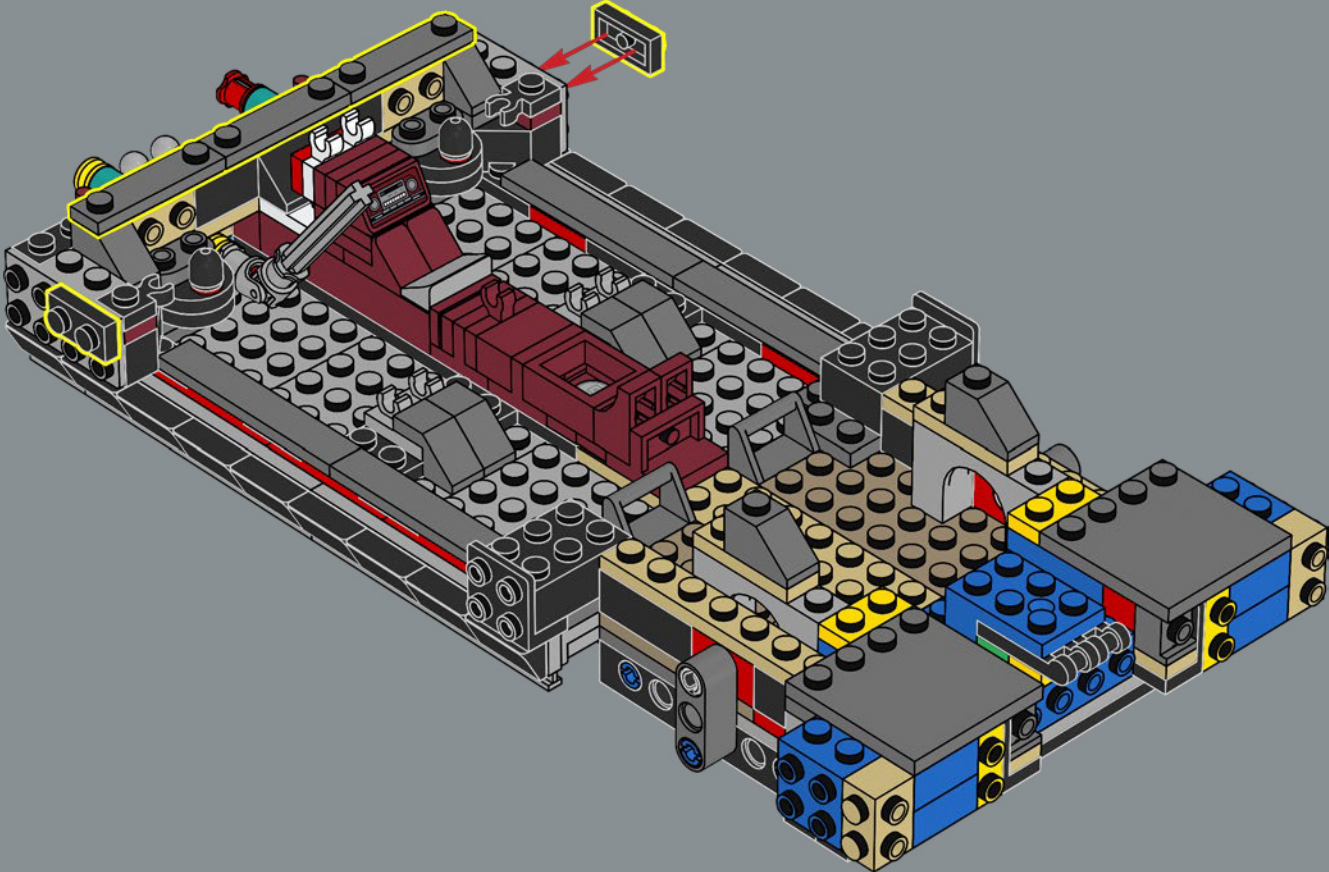

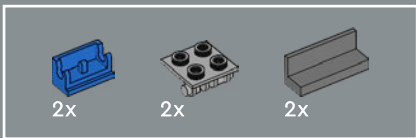

57

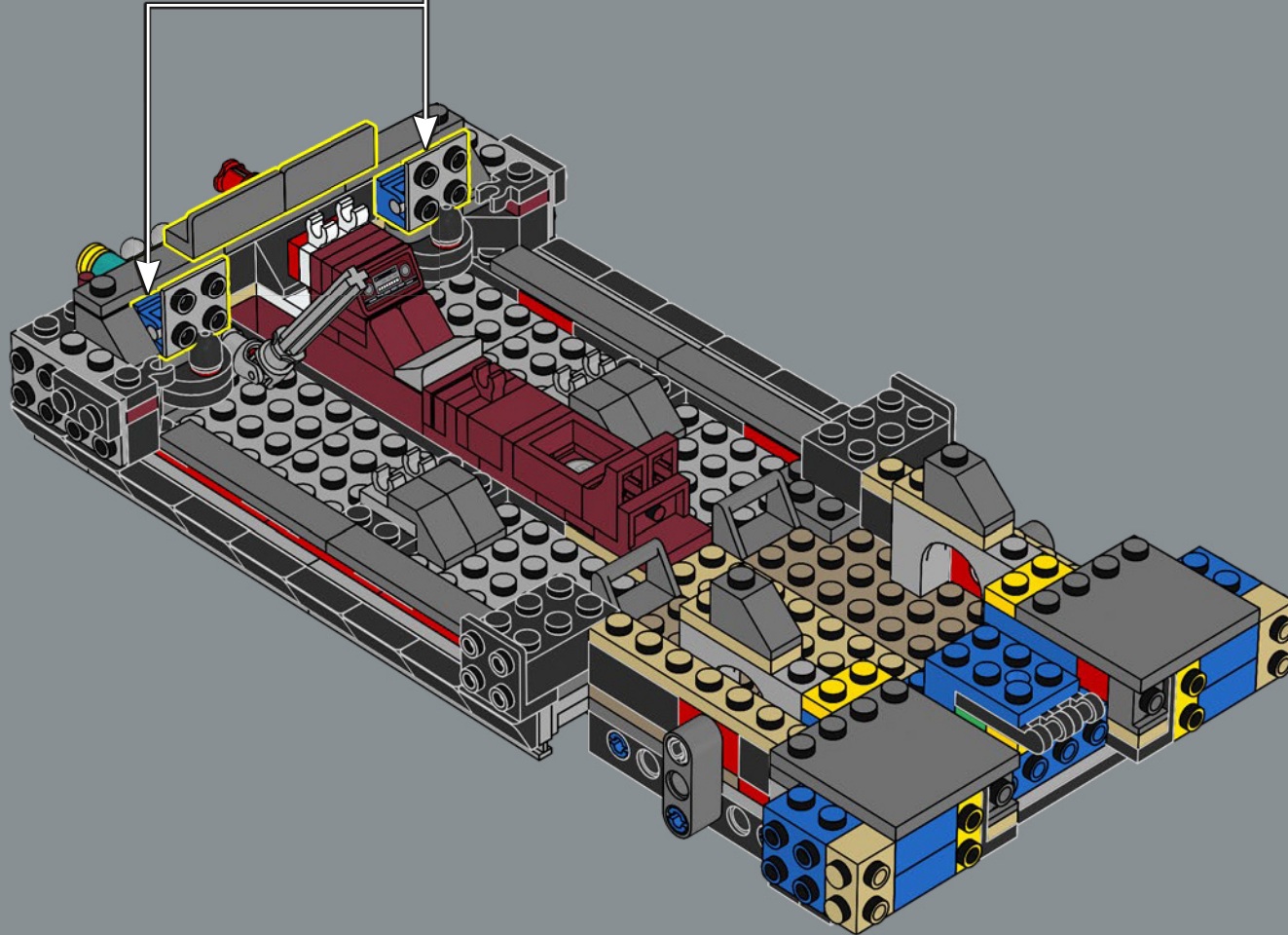
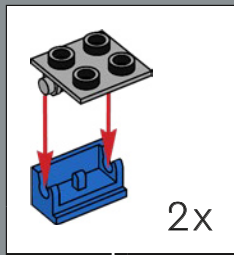

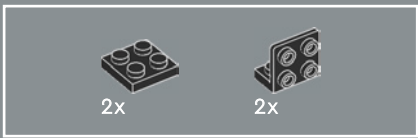

58

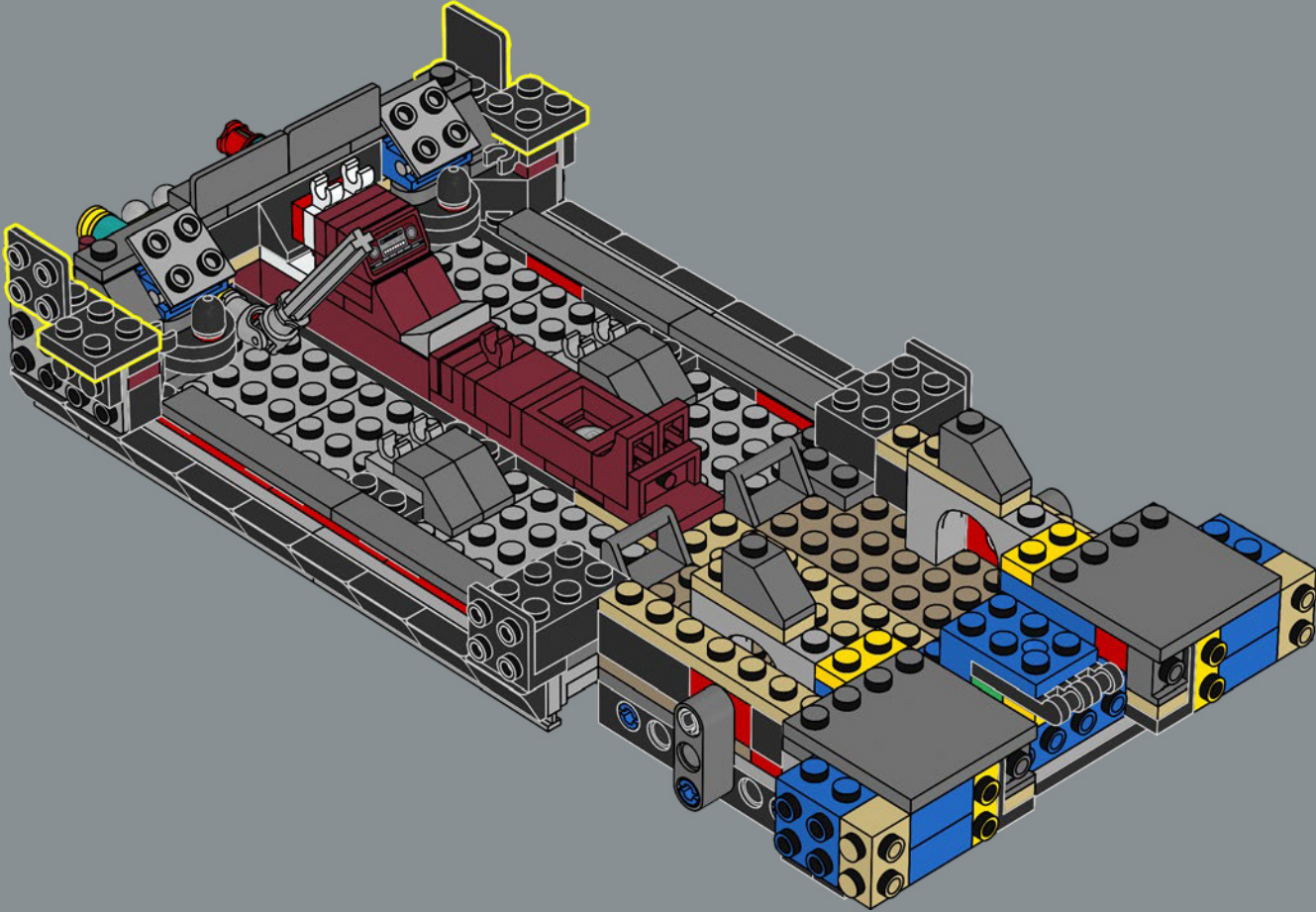

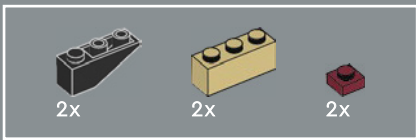

59

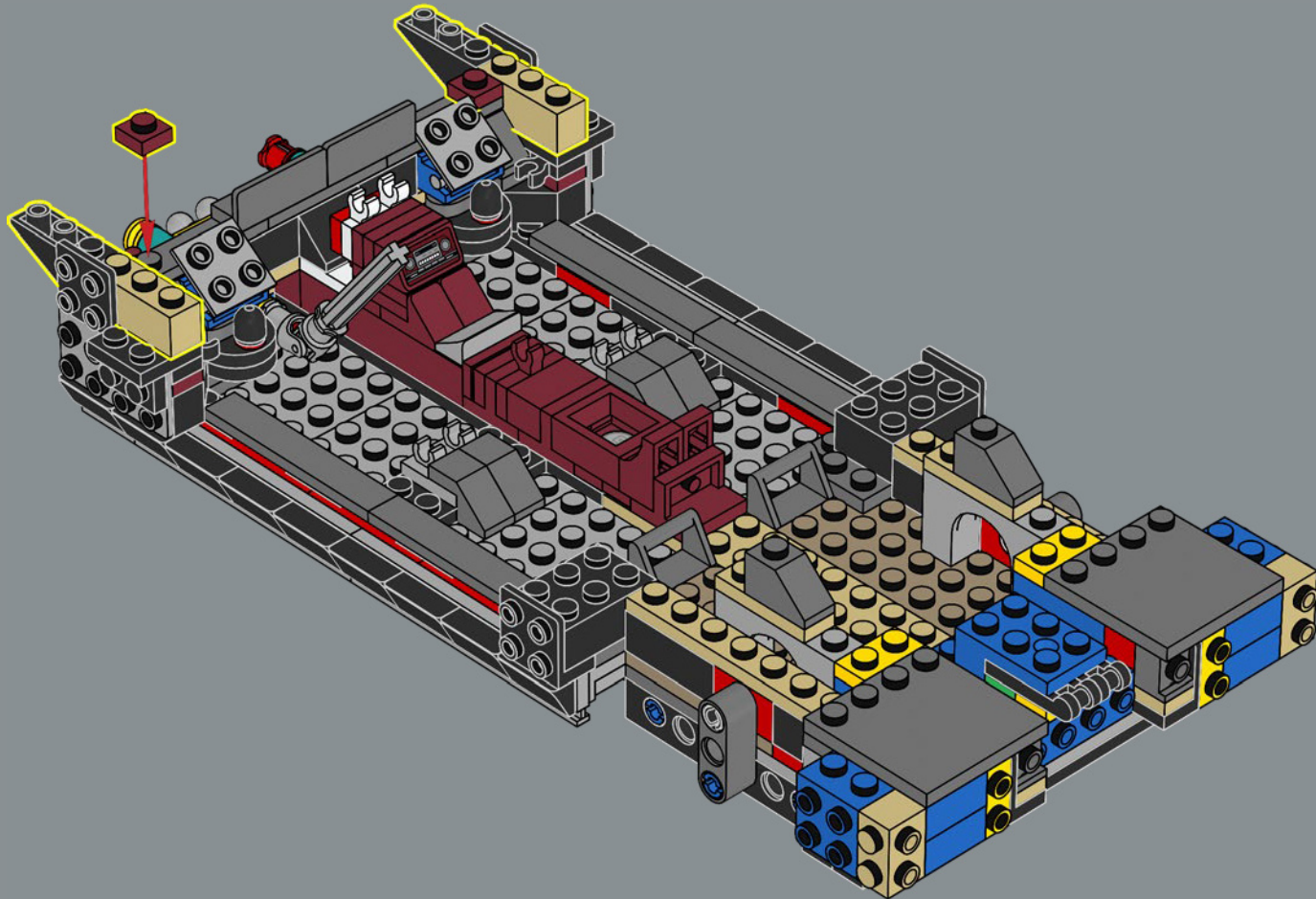



60

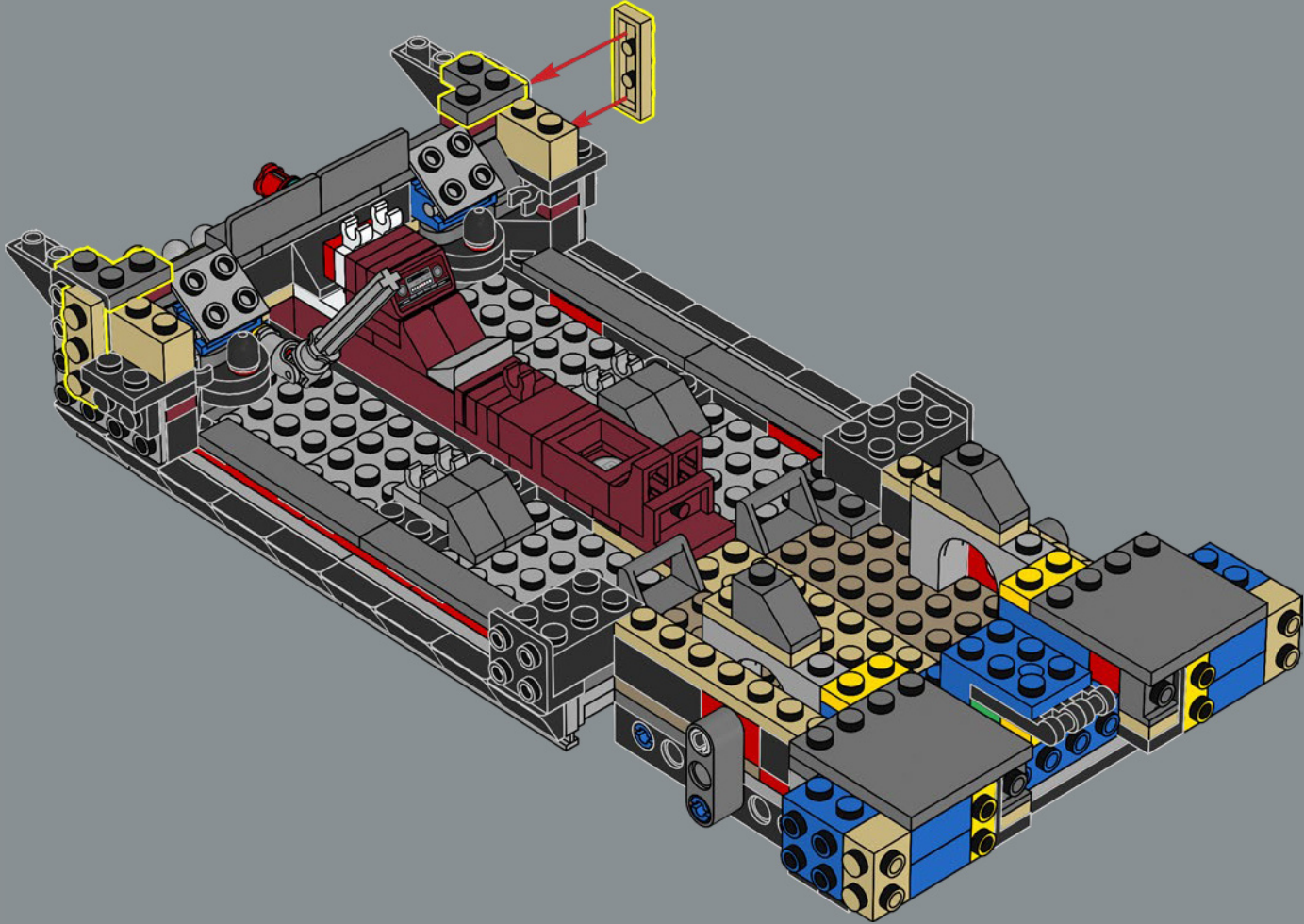

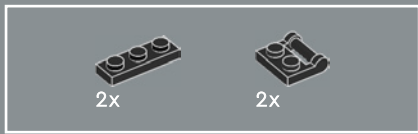

61

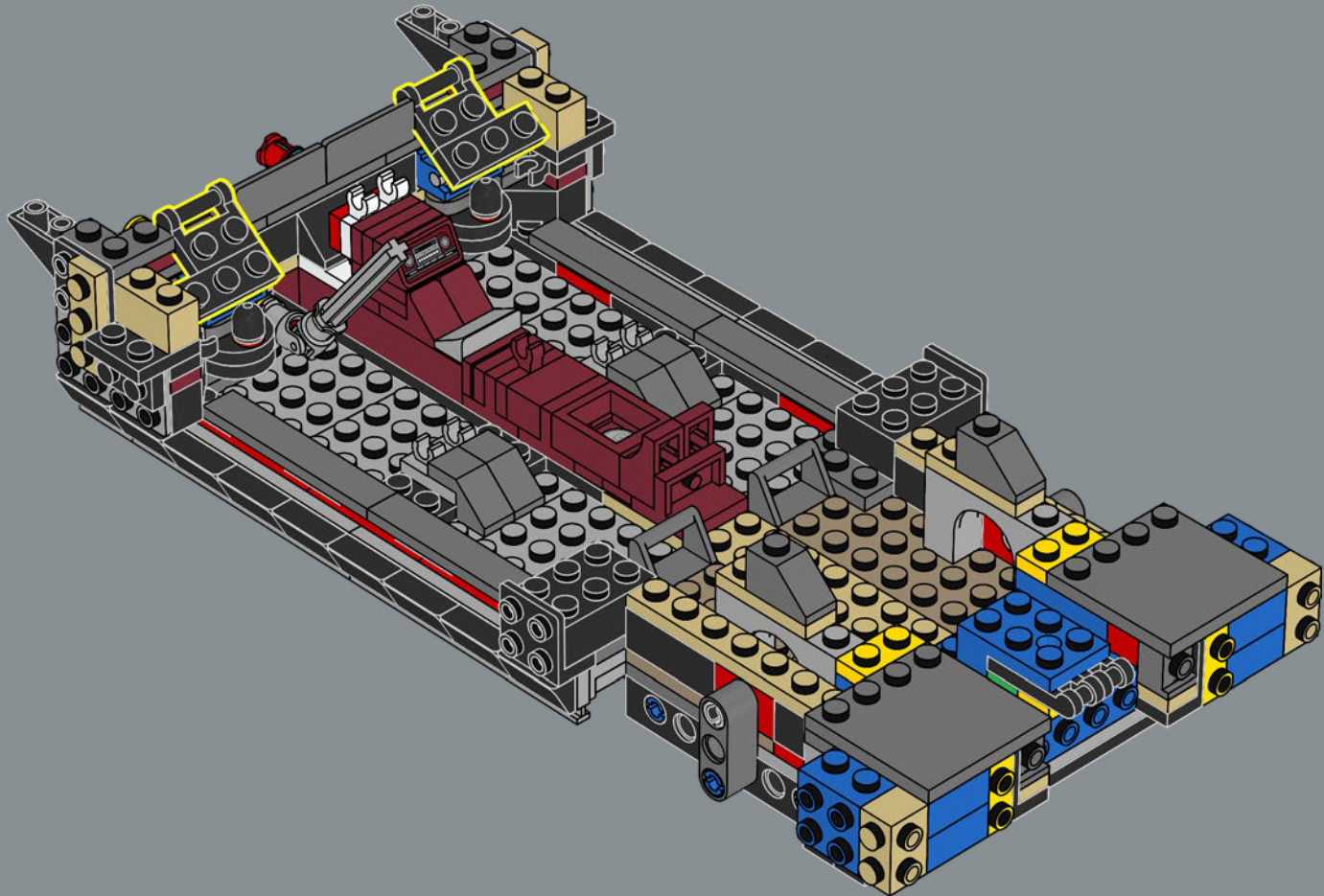

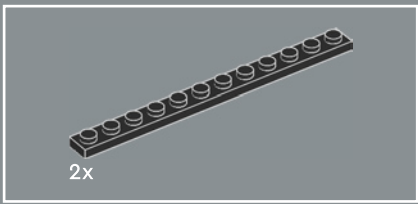

62

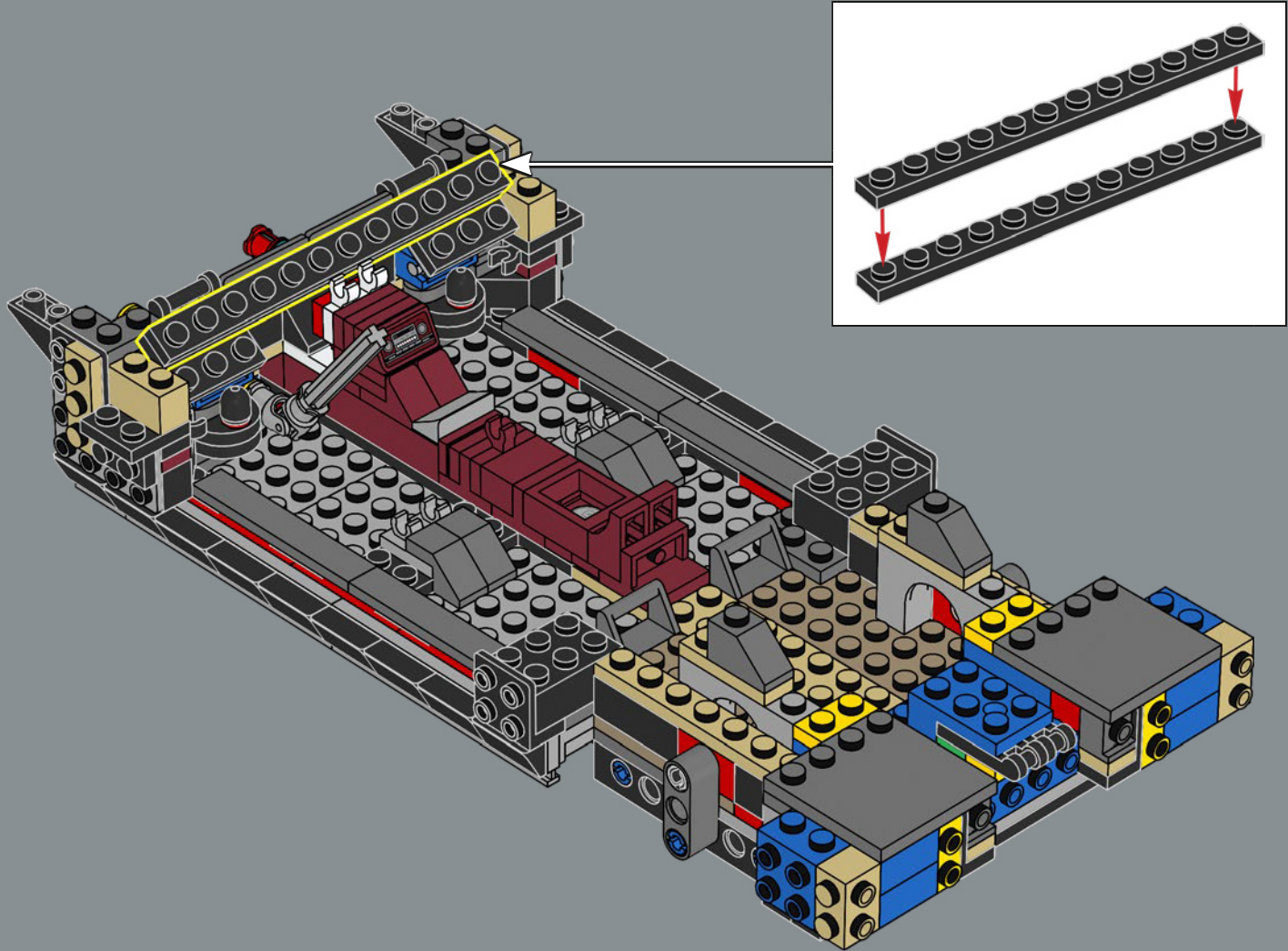

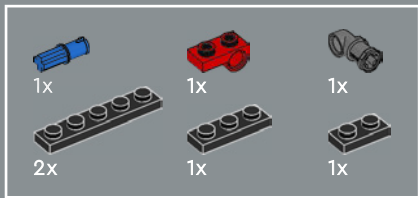

63

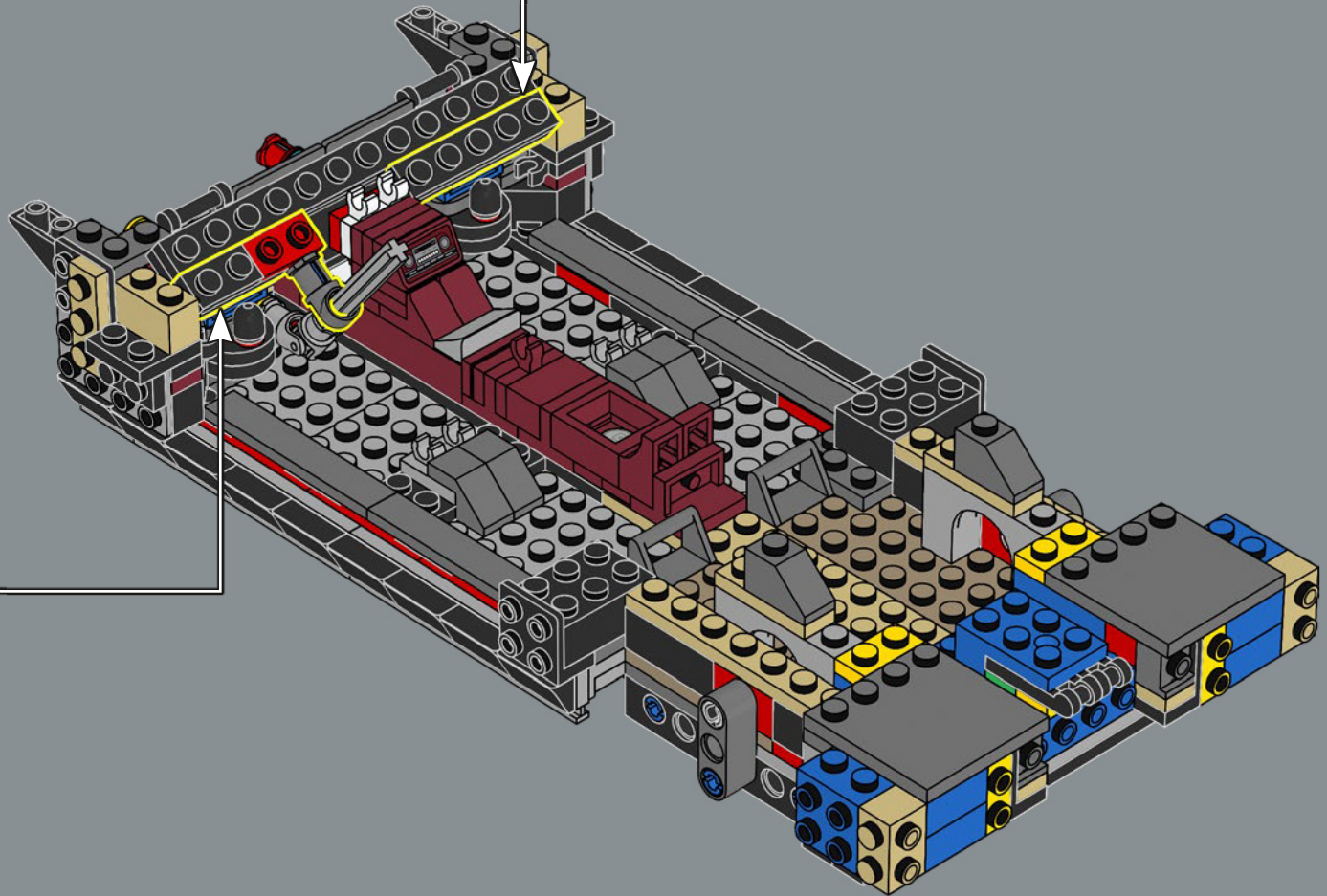
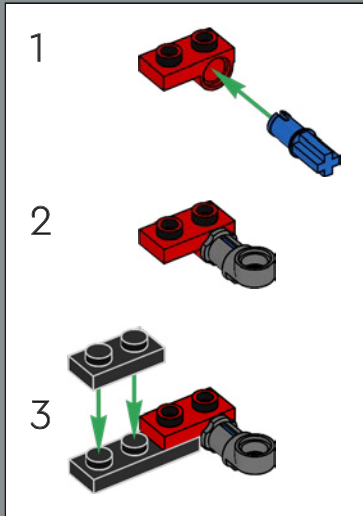
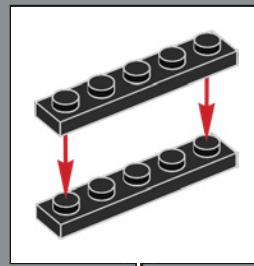

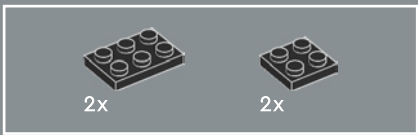

64

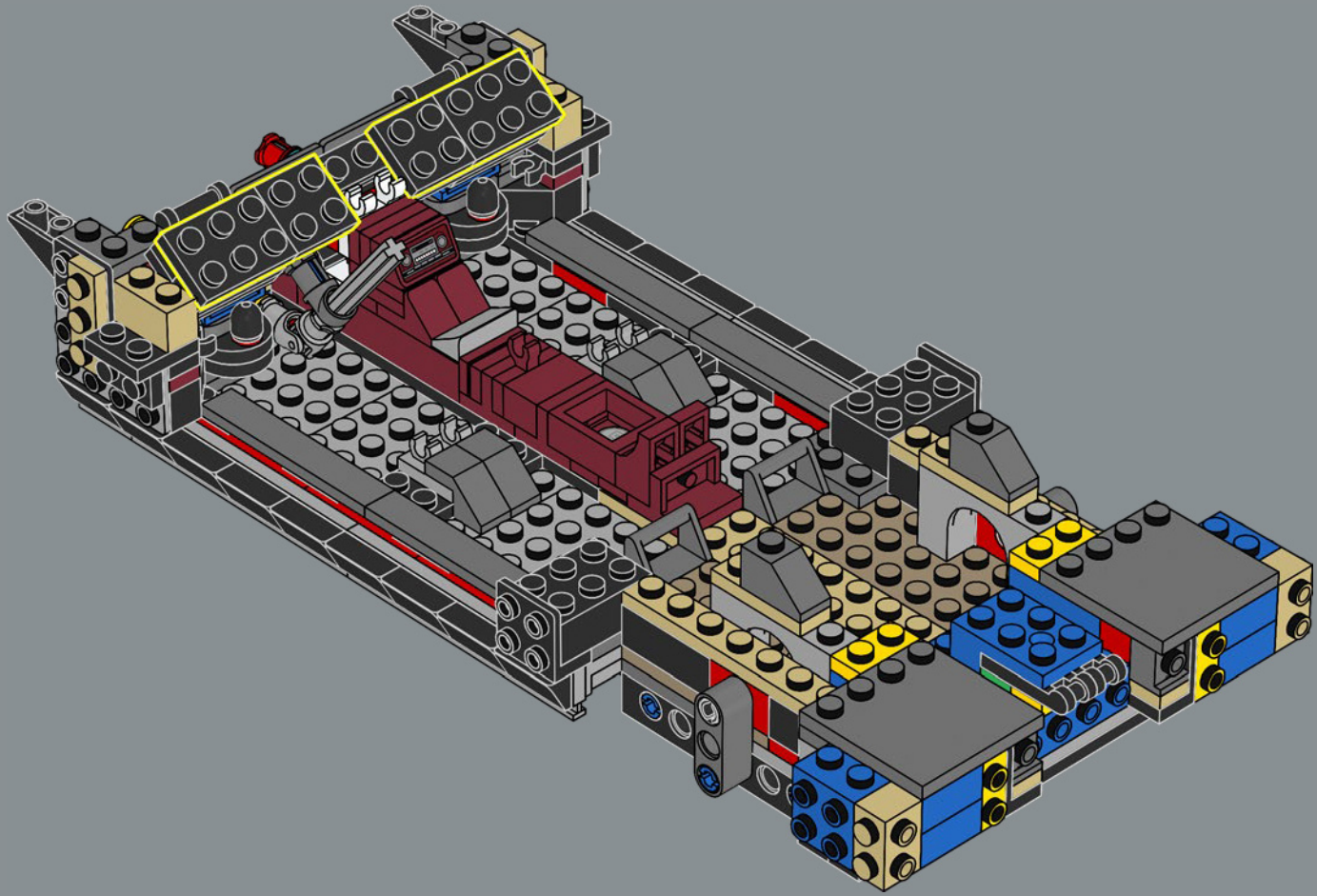



65

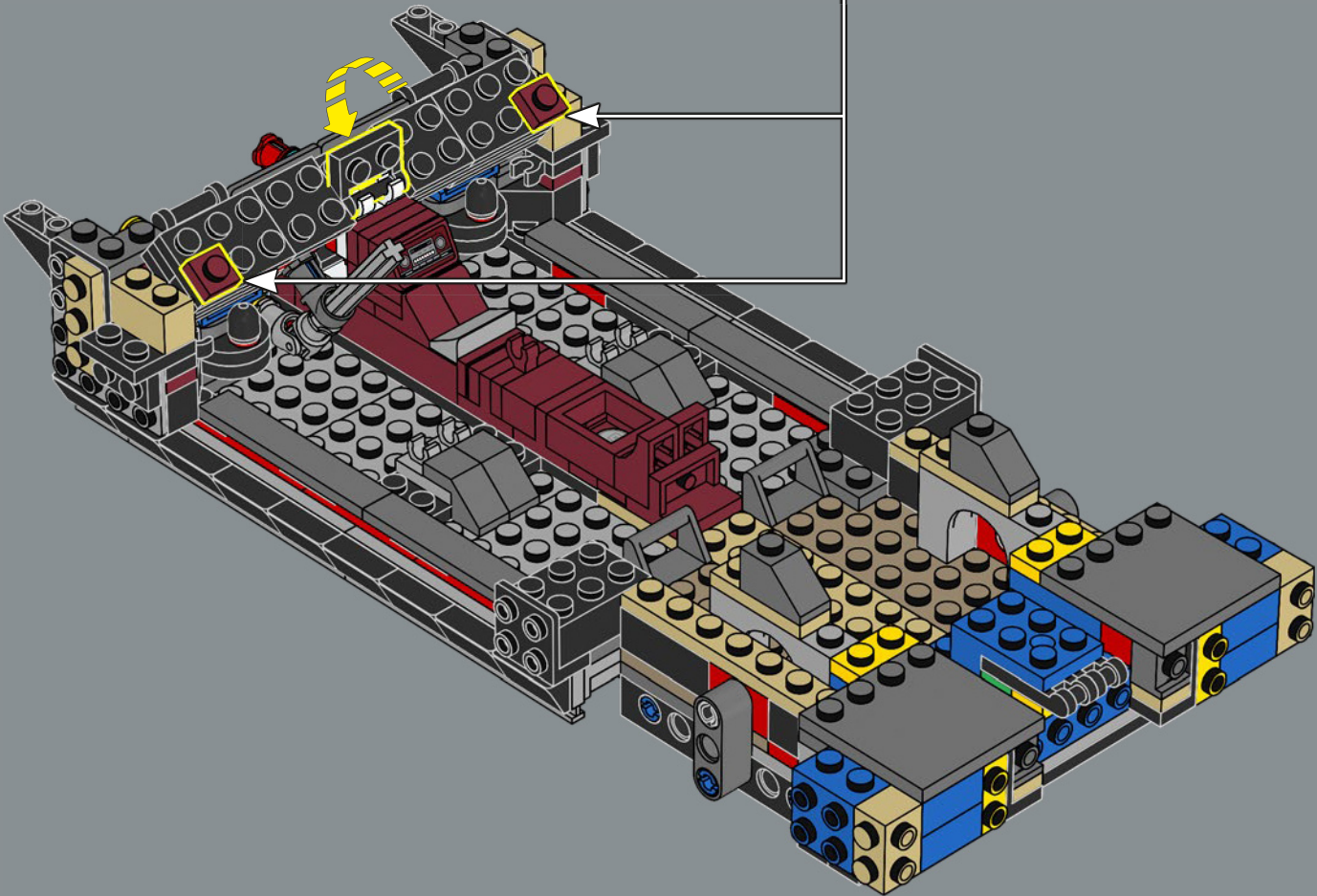
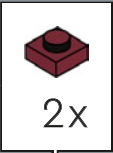

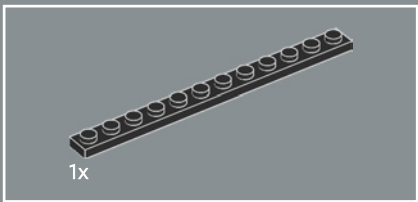

66

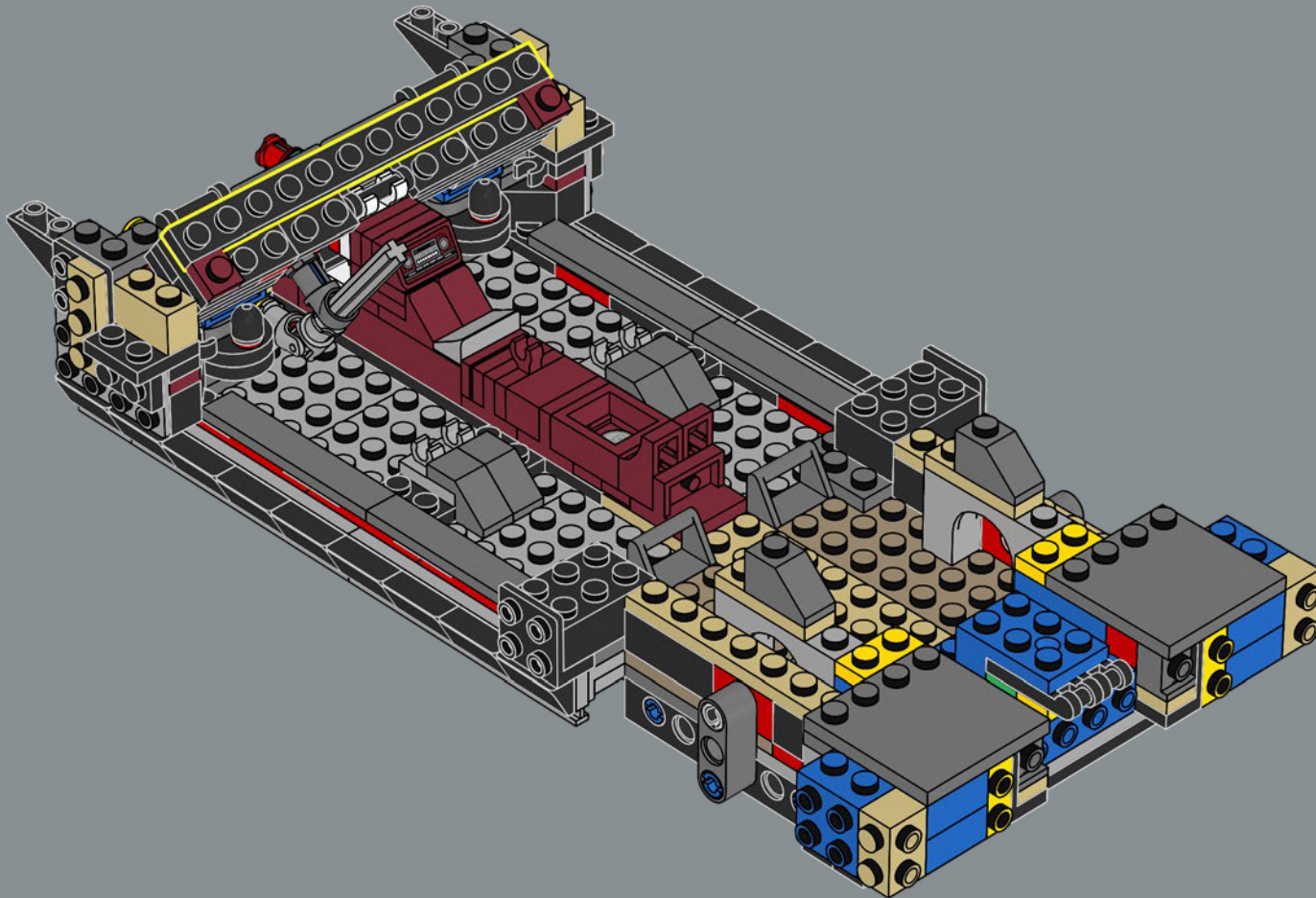

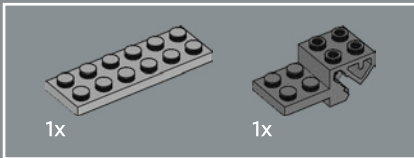
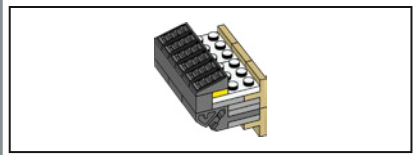

67

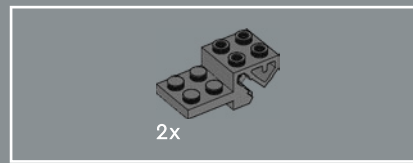
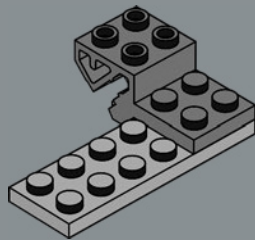

68

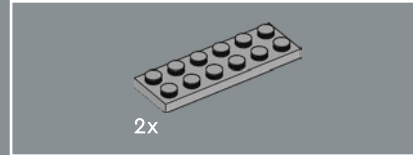
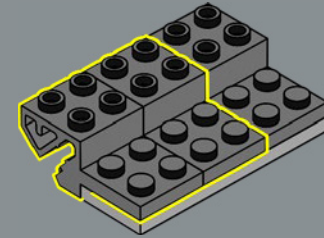

69

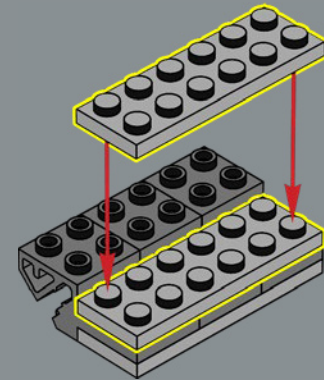

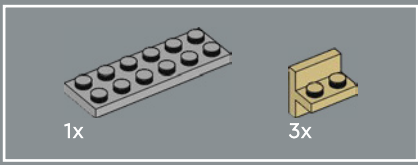

70

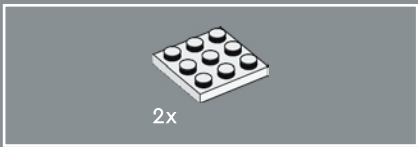
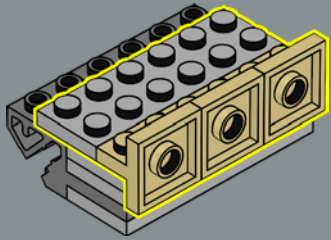

71

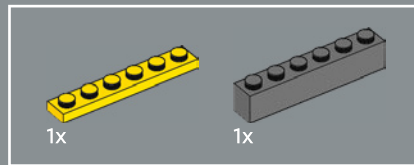
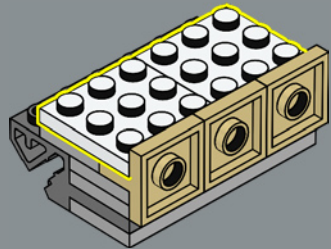

72

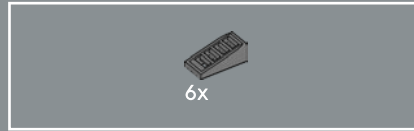
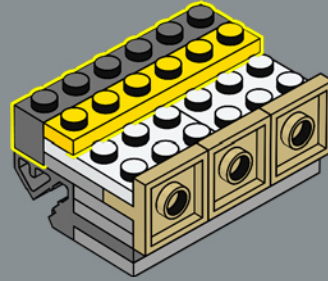

73

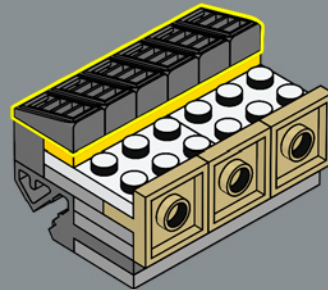

74

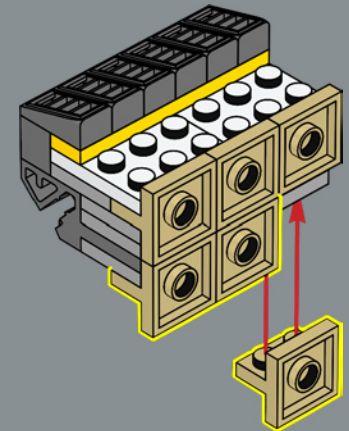

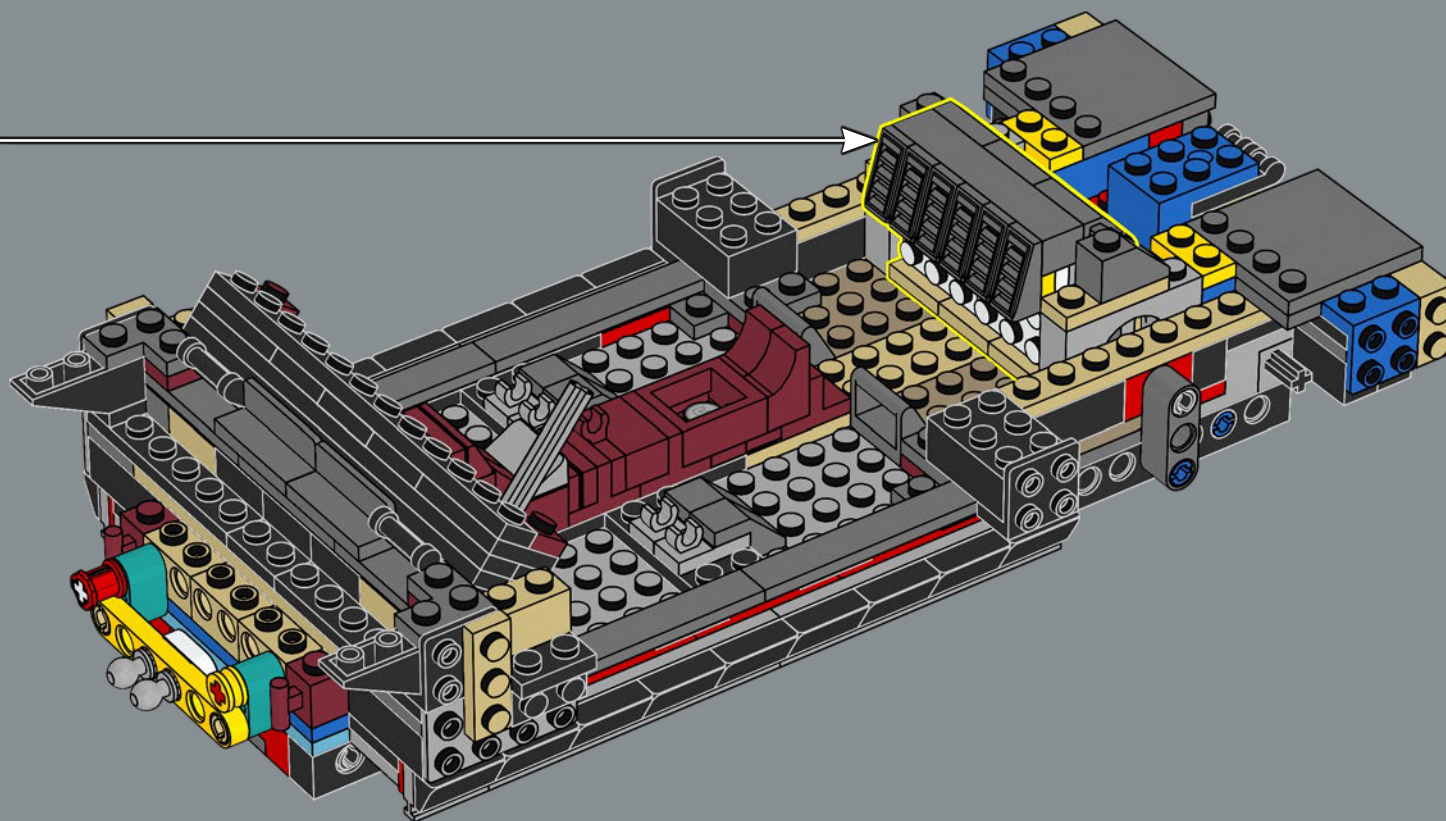

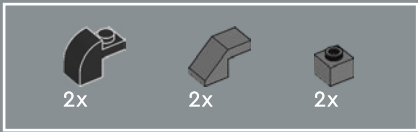

76

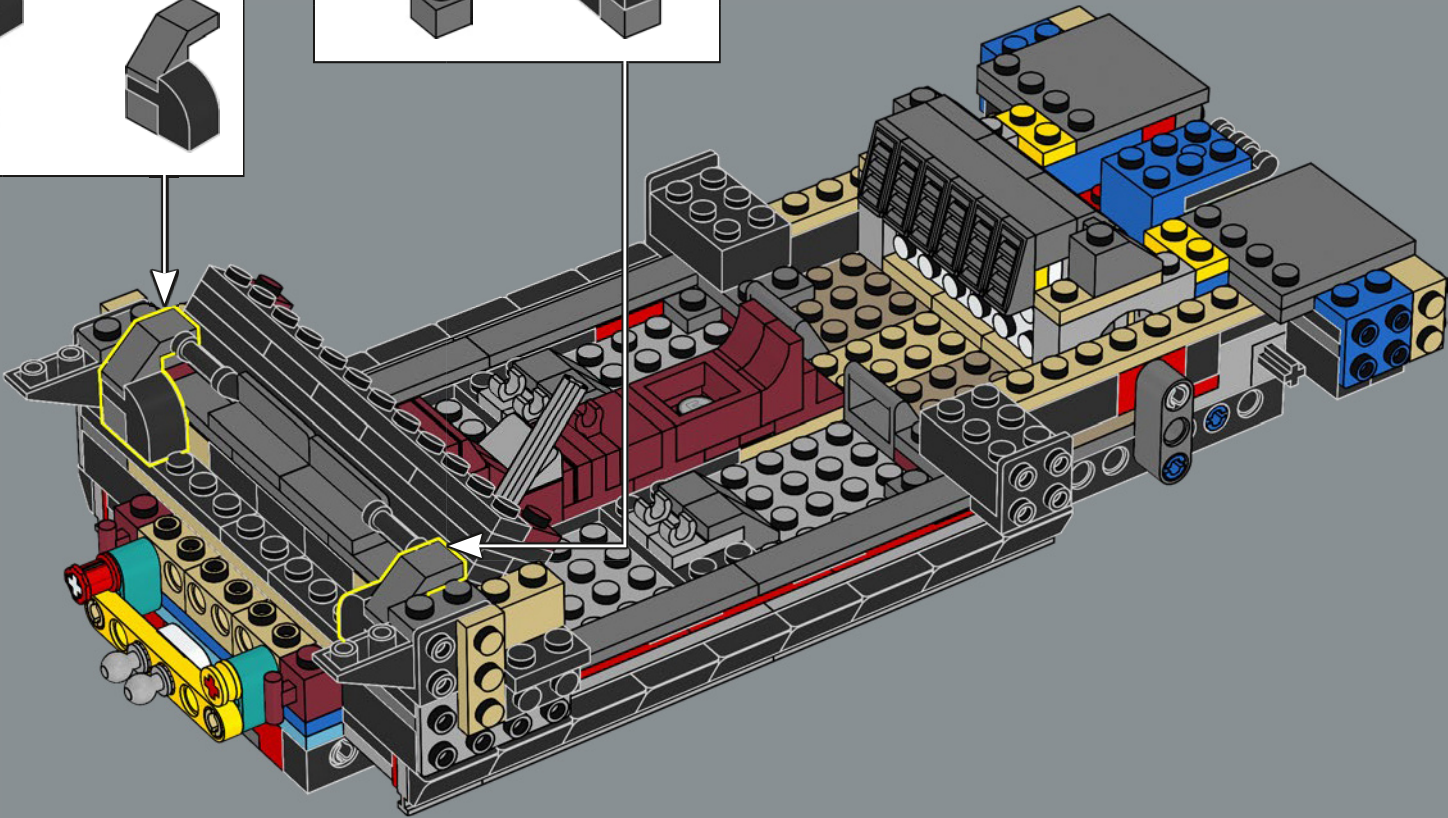
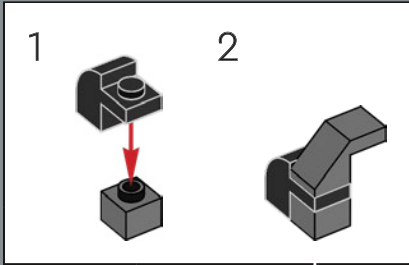
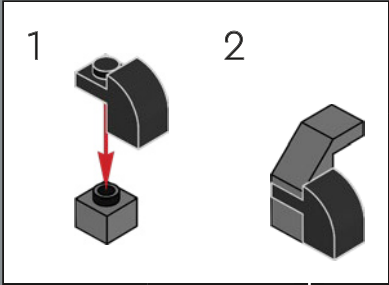

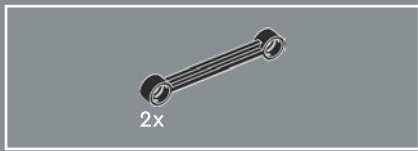

Une Camaro Z11 décapotable spéciale a servi de voiture de sécurité officielle lors des 500 miles d'Indianapolis en 1969.

77

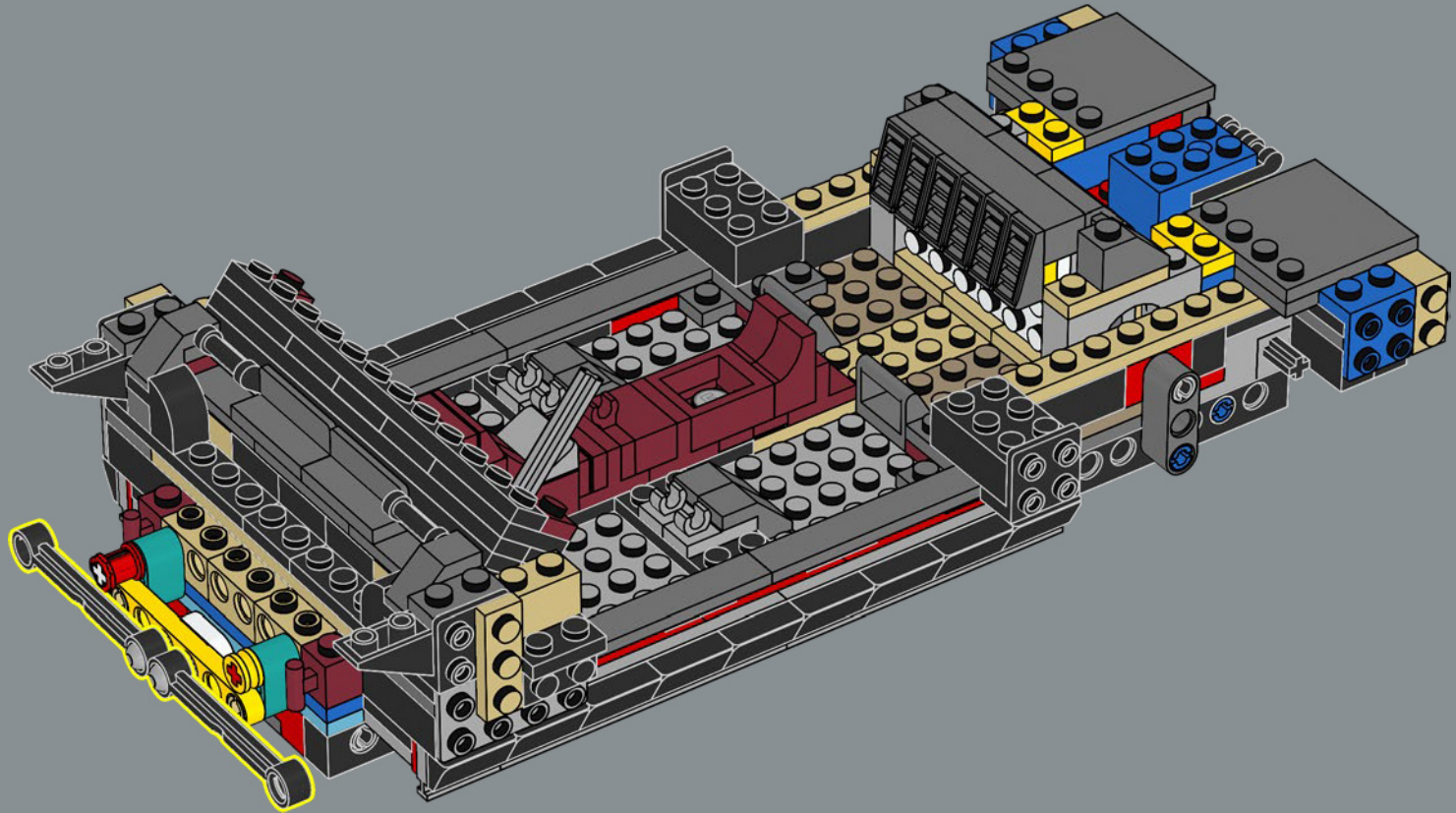

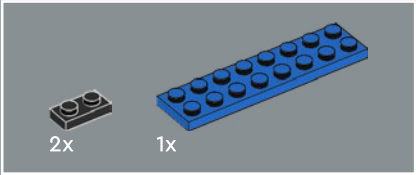
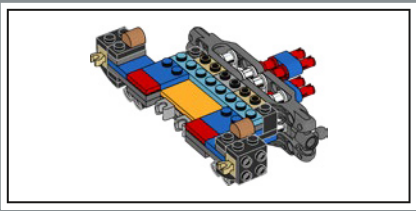

78

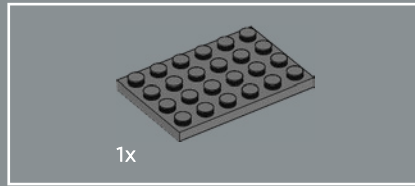
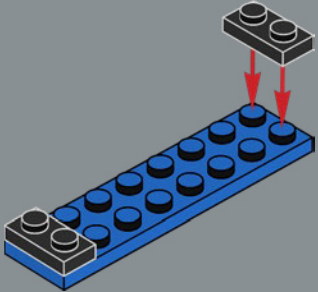

79

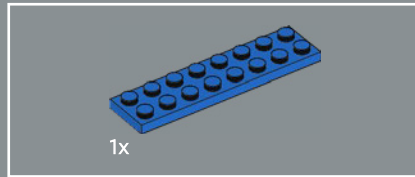
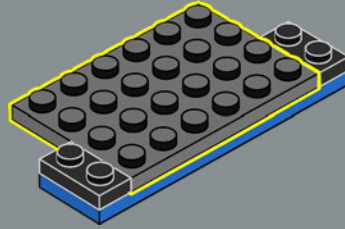

80

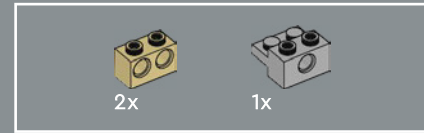
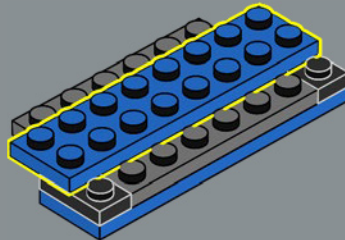

81

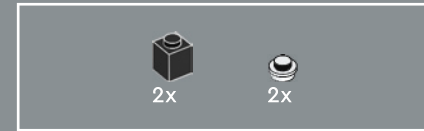
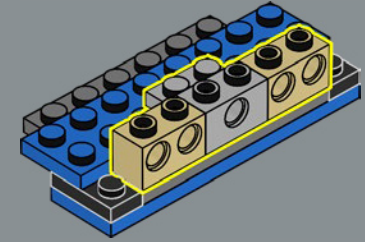

82

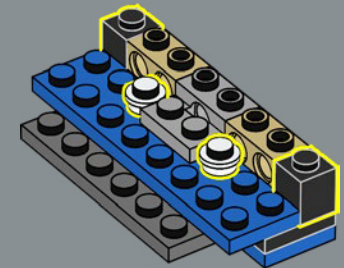



83

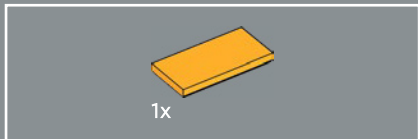
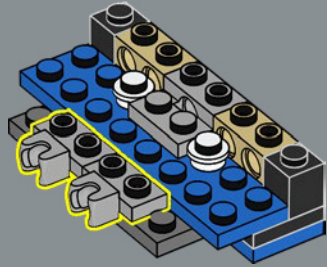

84

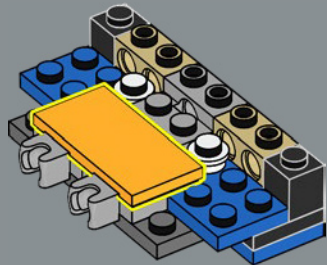

85

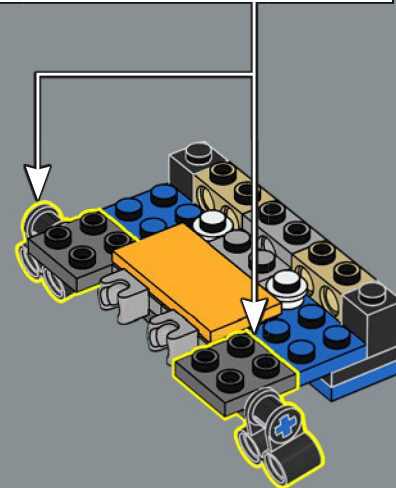
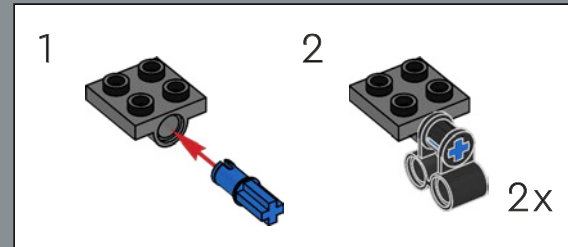

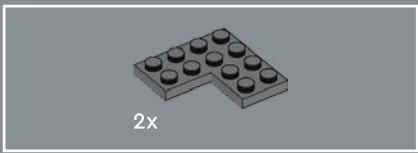

86

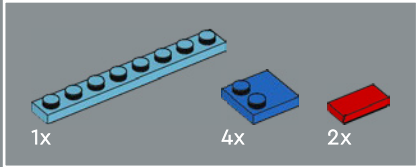
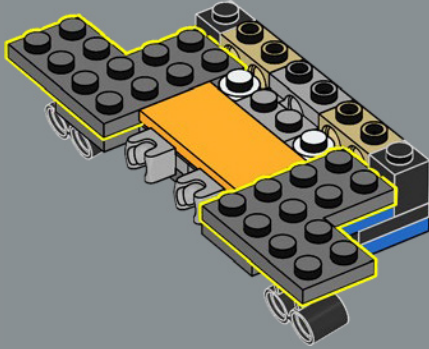

87

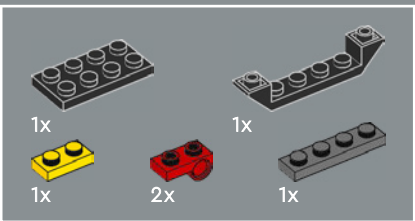
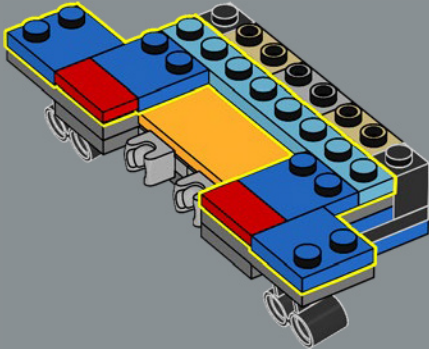

88

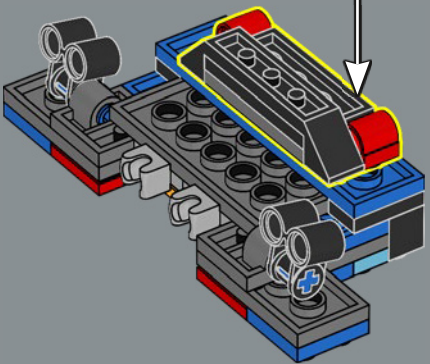
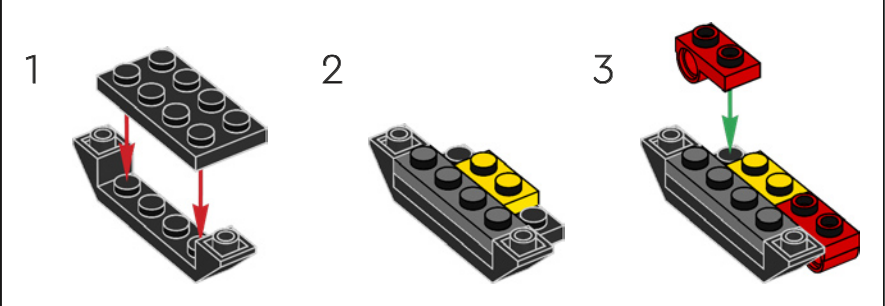

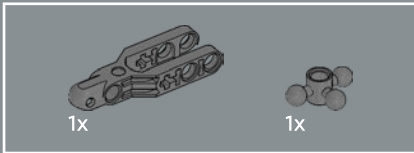
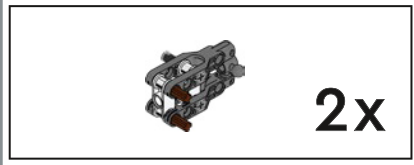
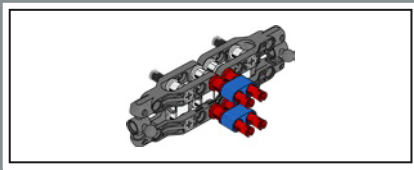

89

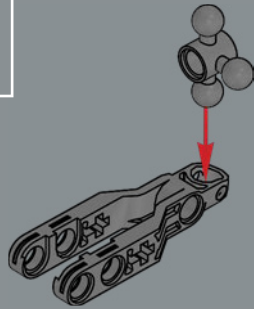

90

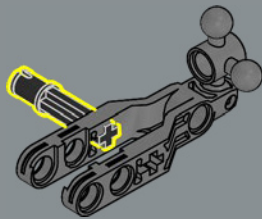

91

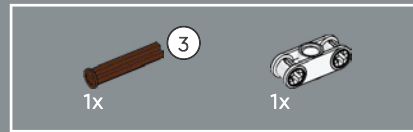
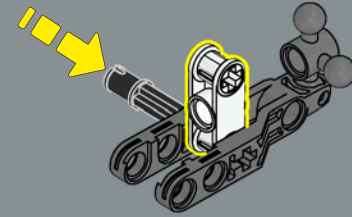

92

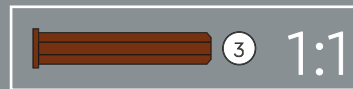
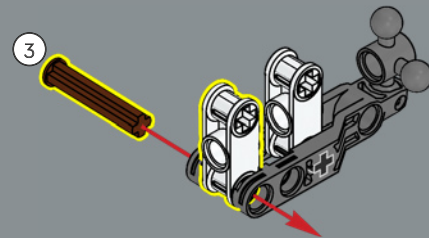



93

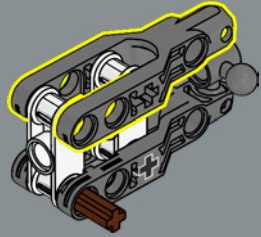

94

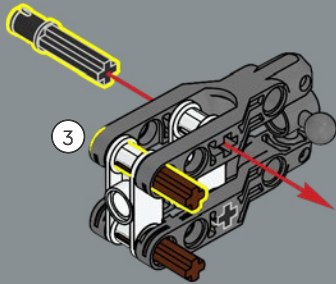

2x



95

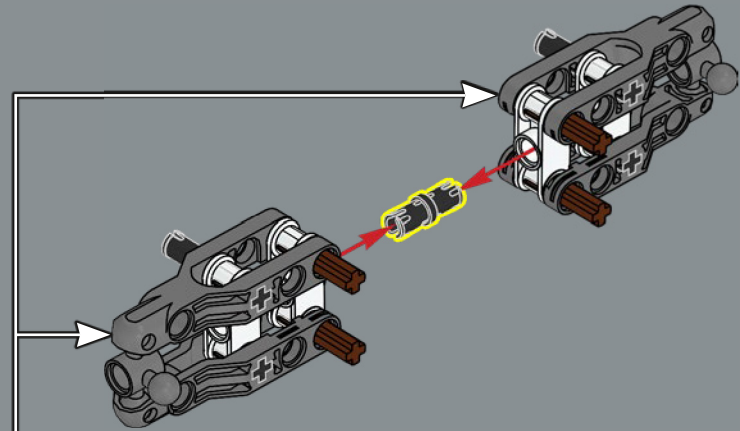



96

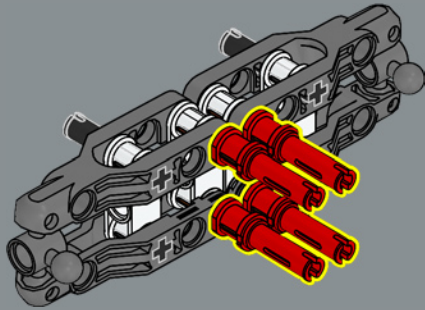

97

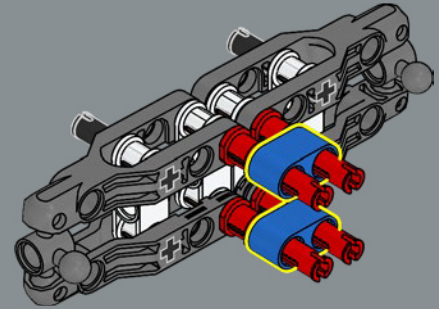

98

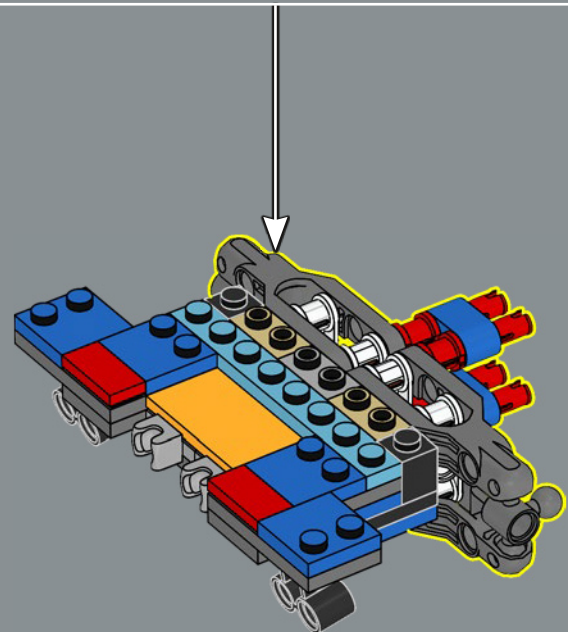

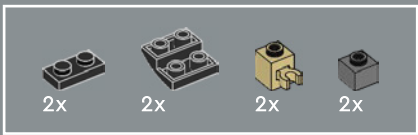

99

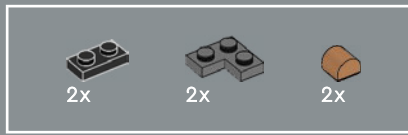
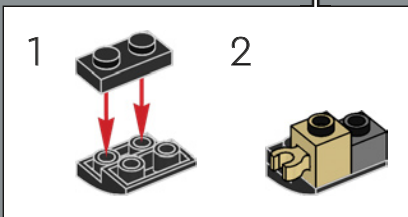
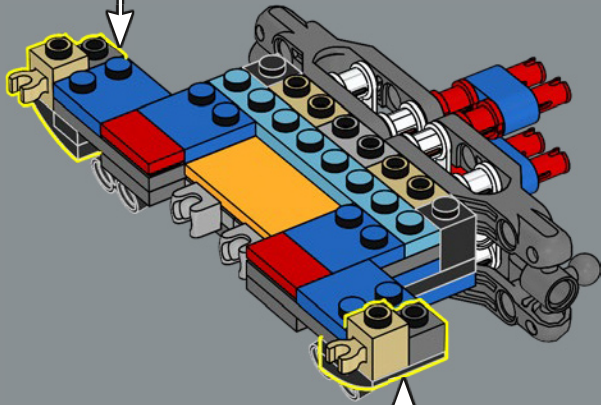
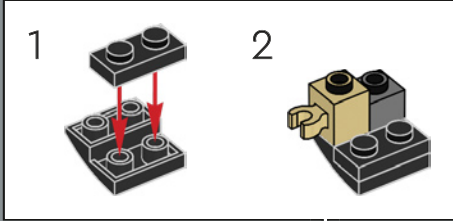

100

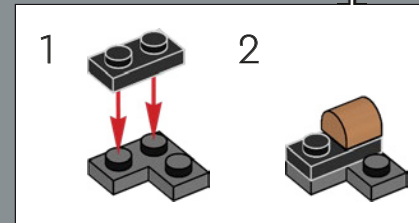
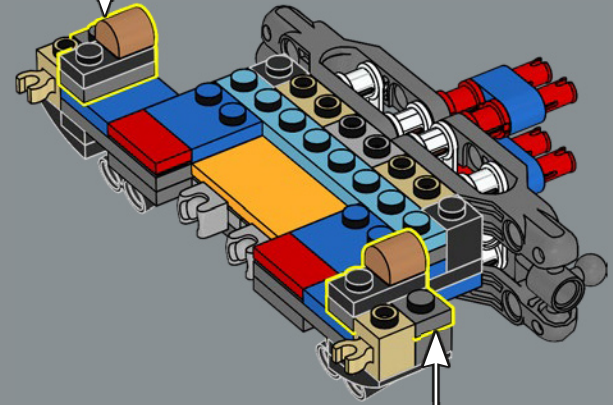
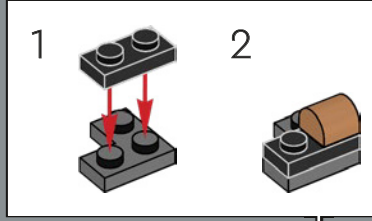



101

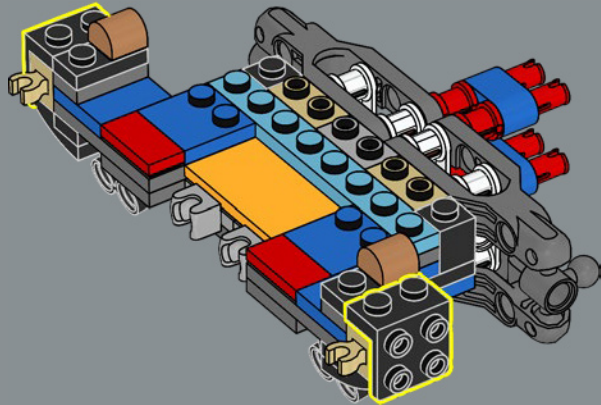

102

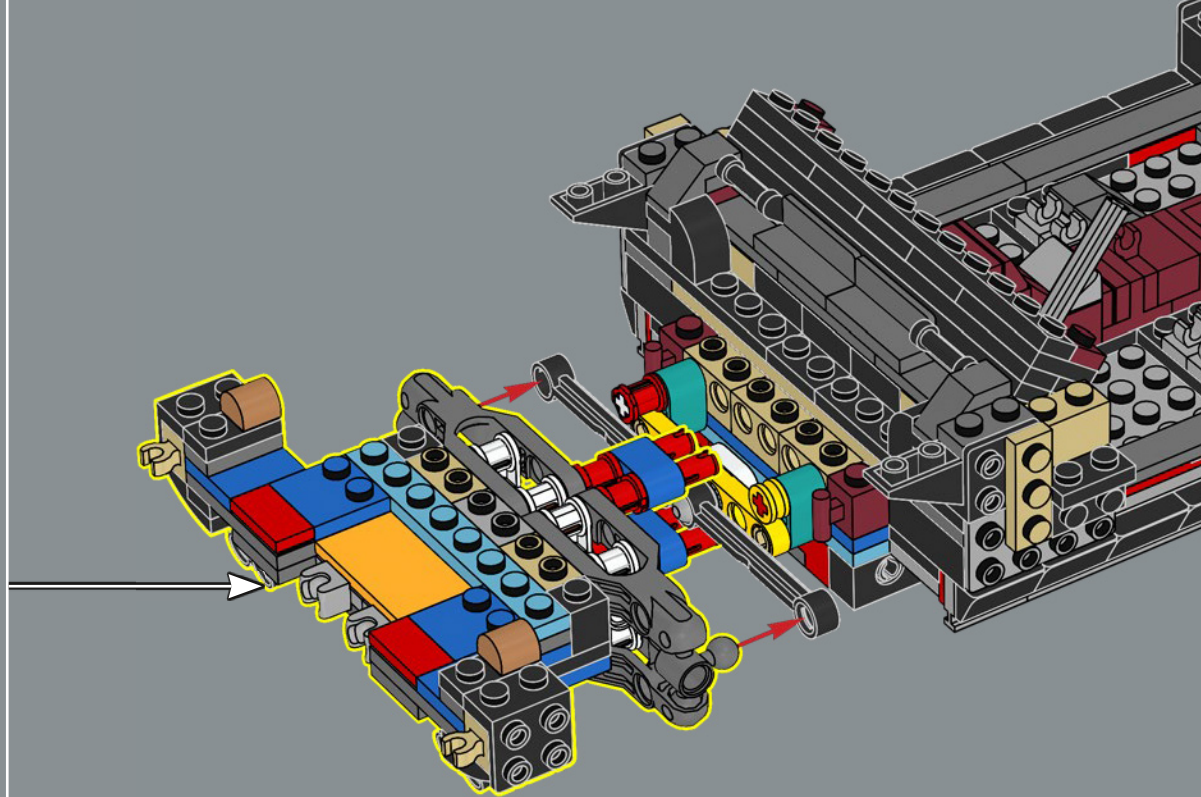

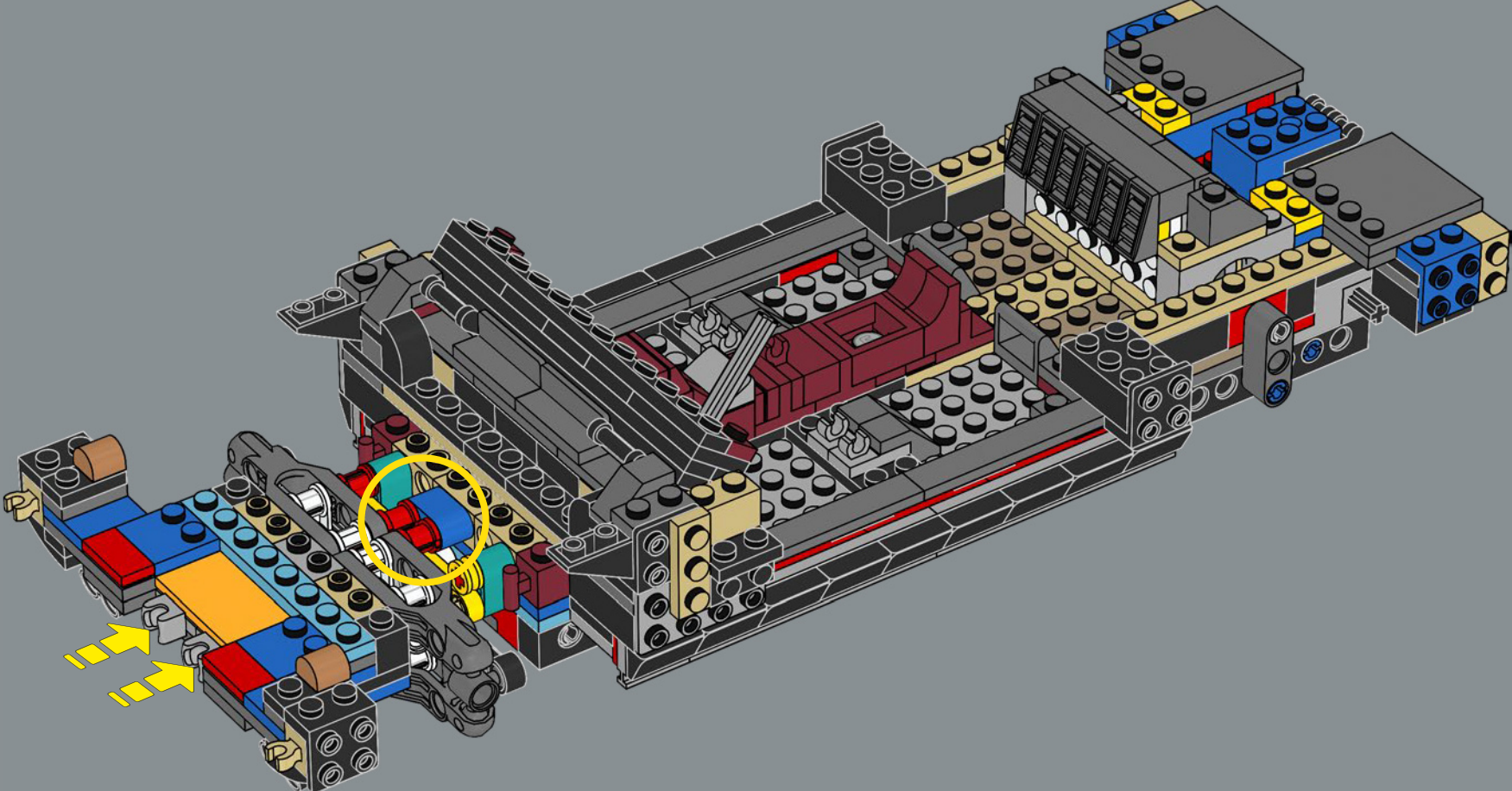

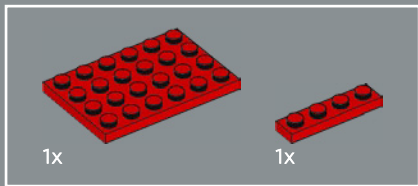

104

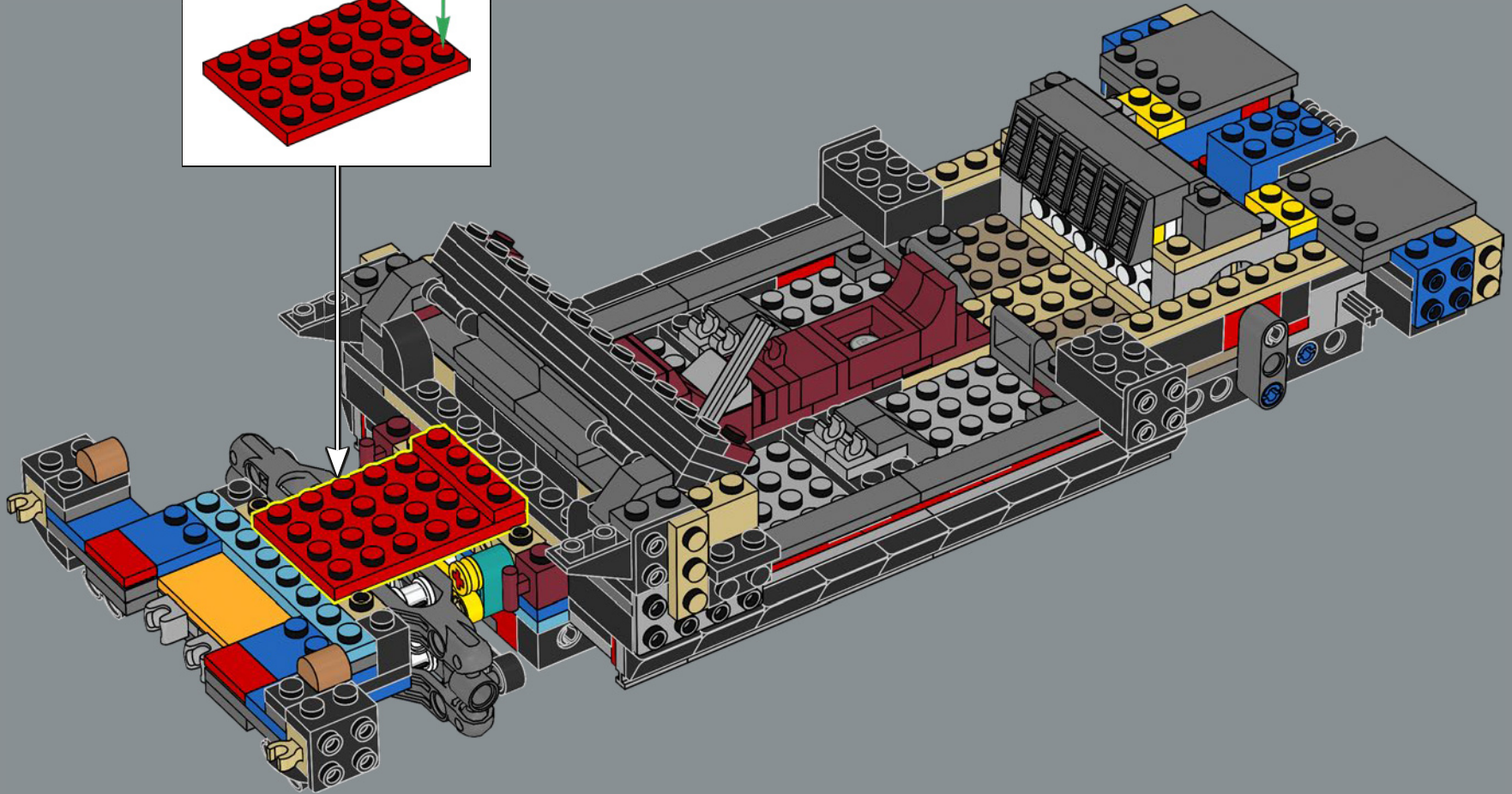
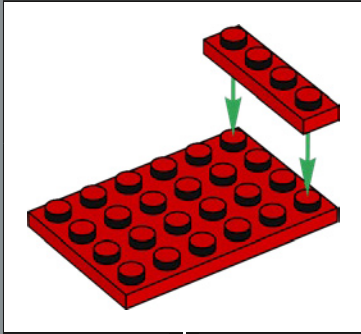

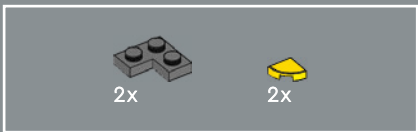

105

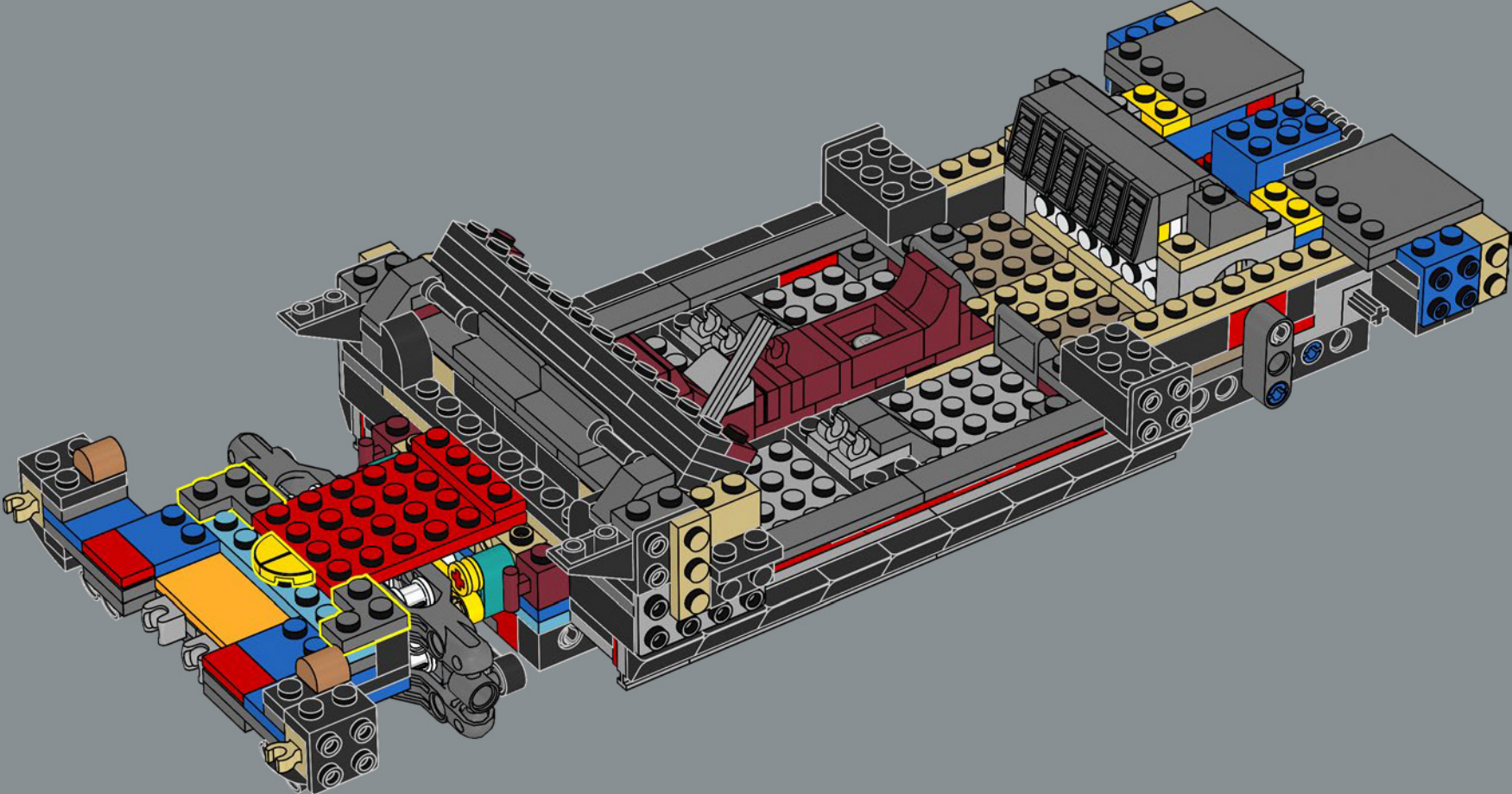

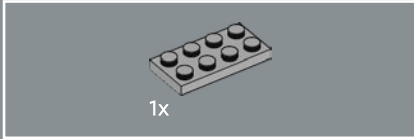
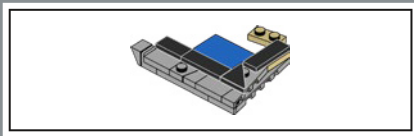

106

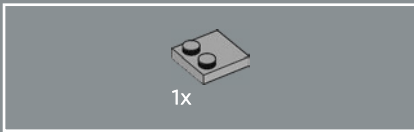
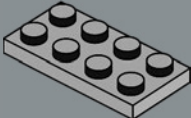

107

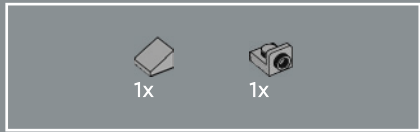
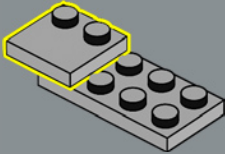

108

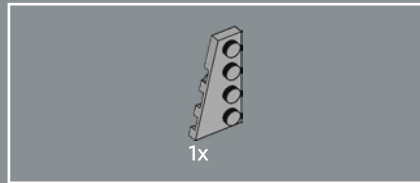
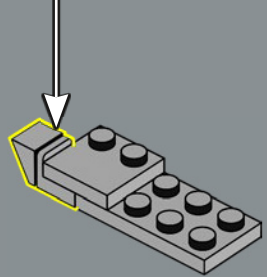
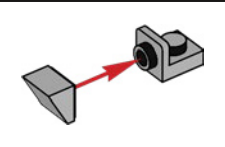

109

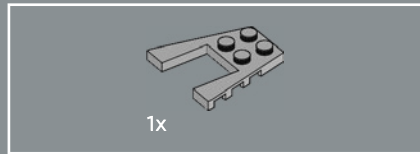
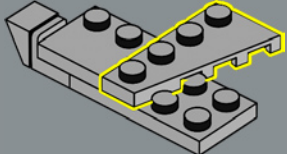

110

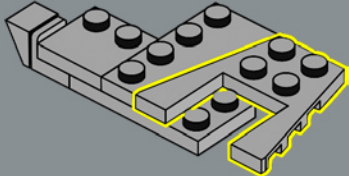

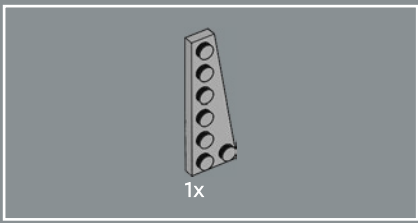

111

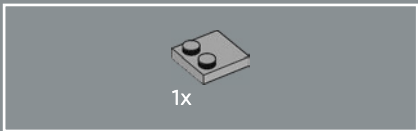
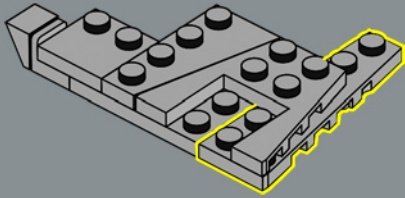

112

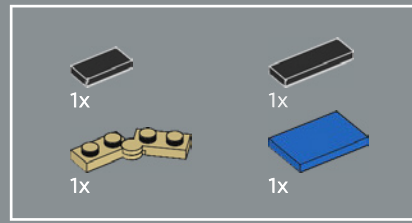
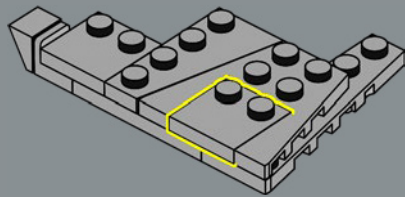

113

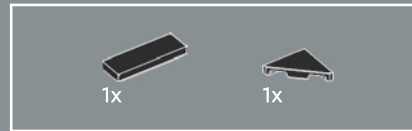
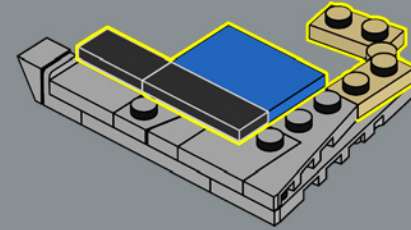

114

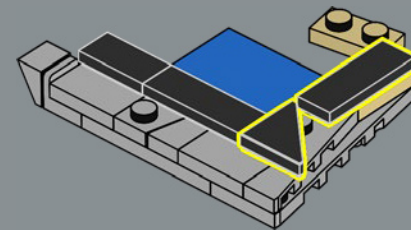

115

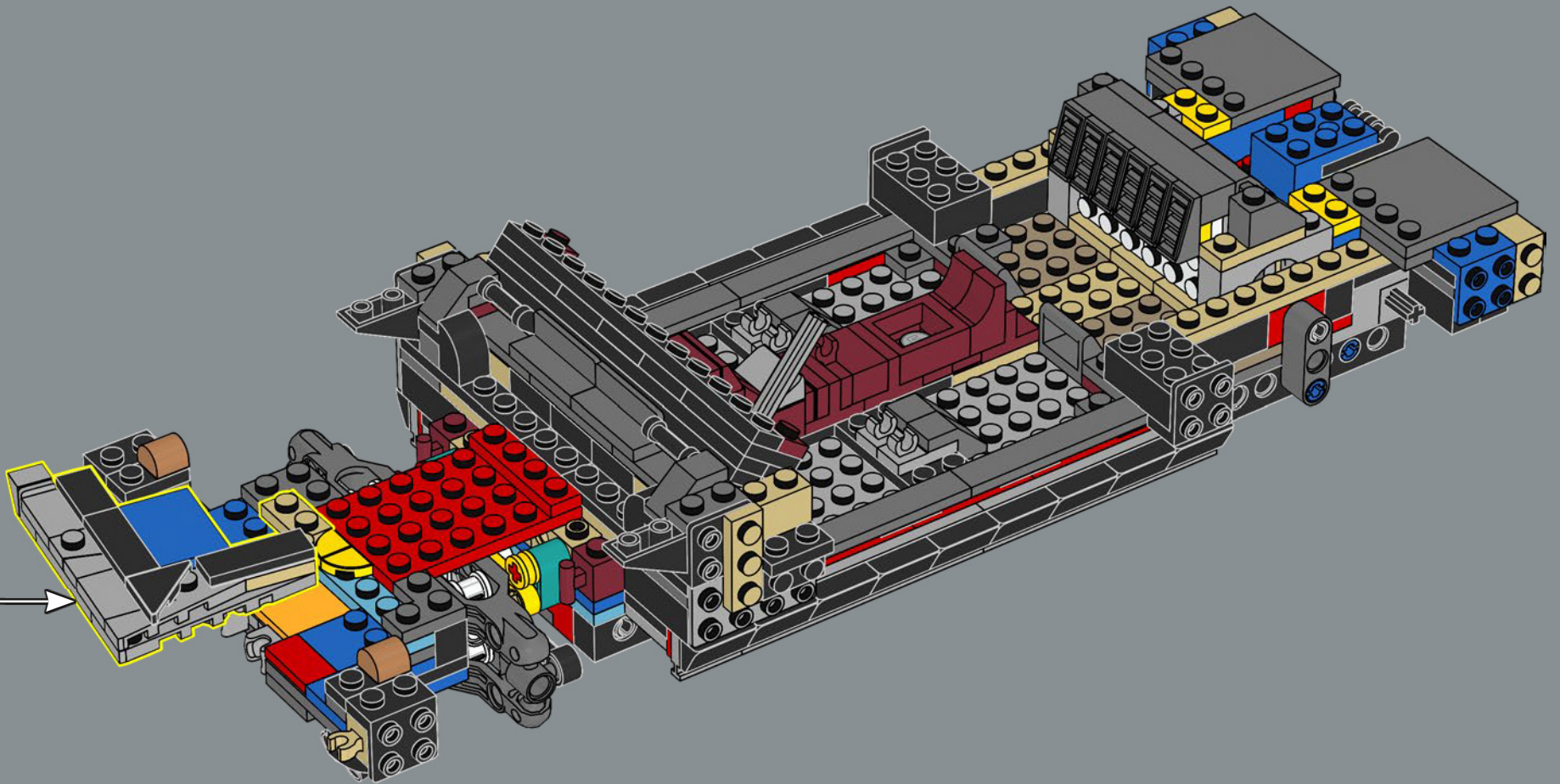

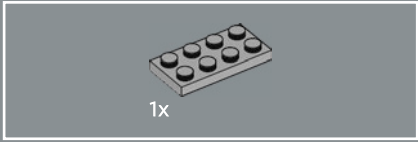
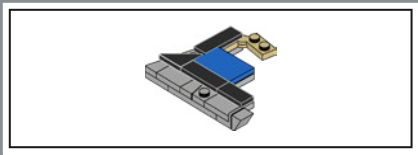

116

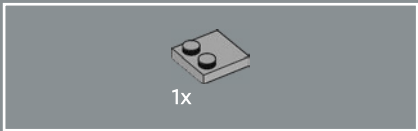
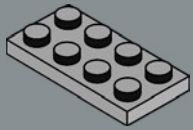

117

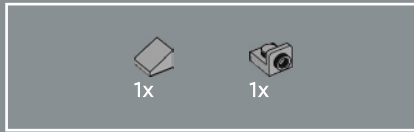
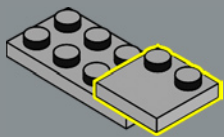

118

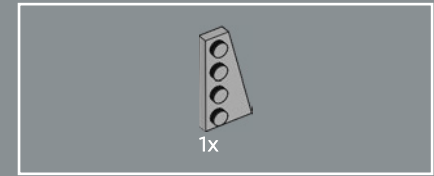
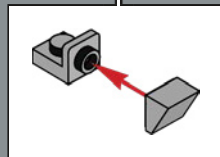
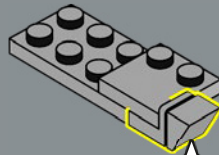

119

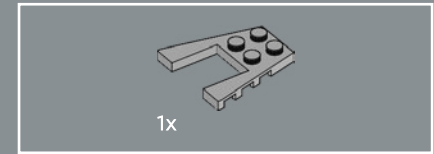
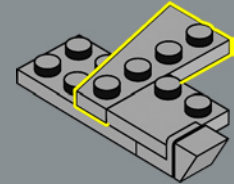

120

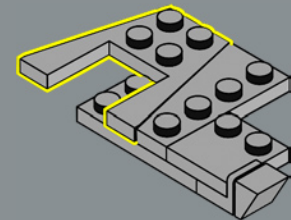

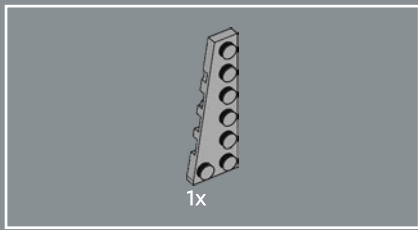

121

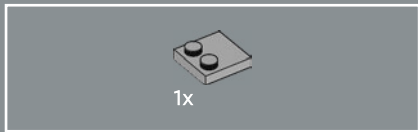
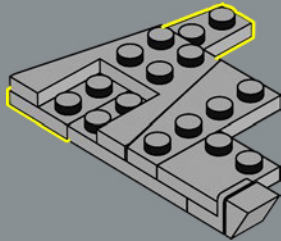

122

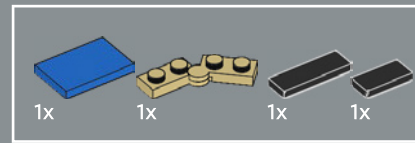
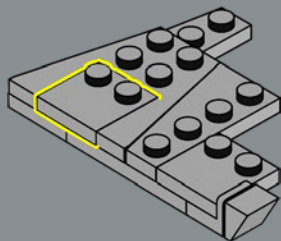

123

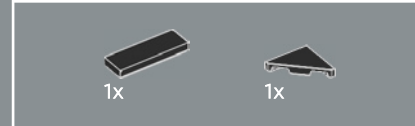
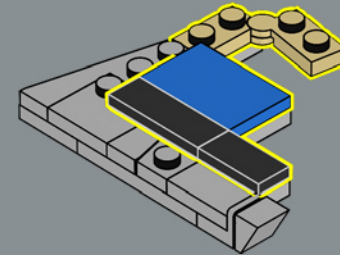

124

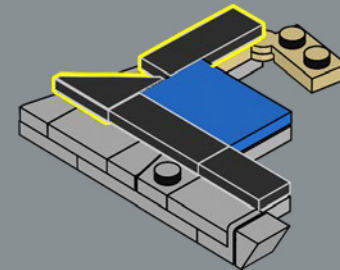

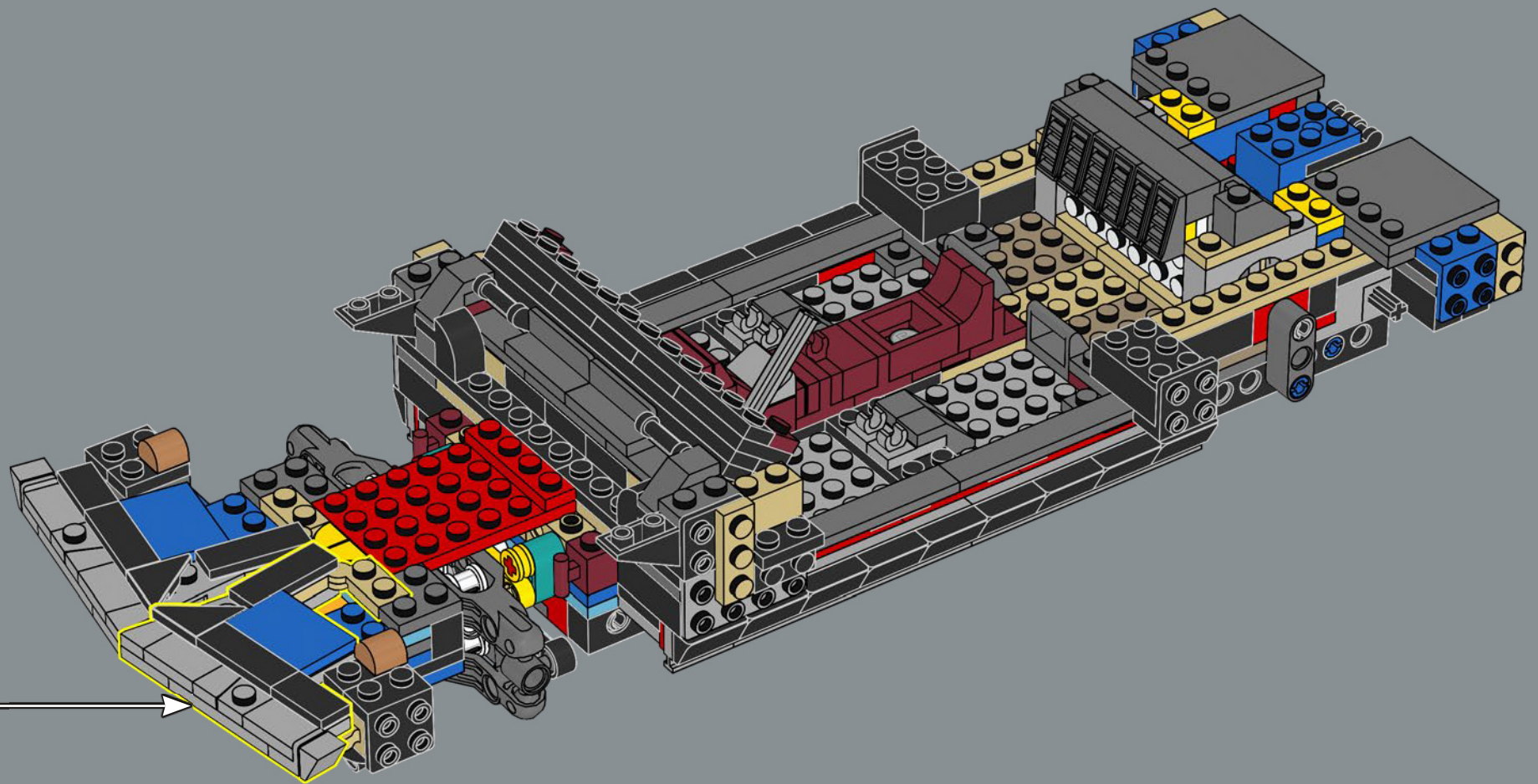

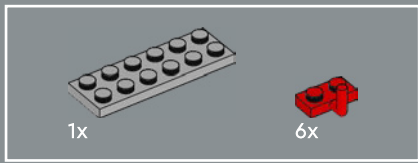

126

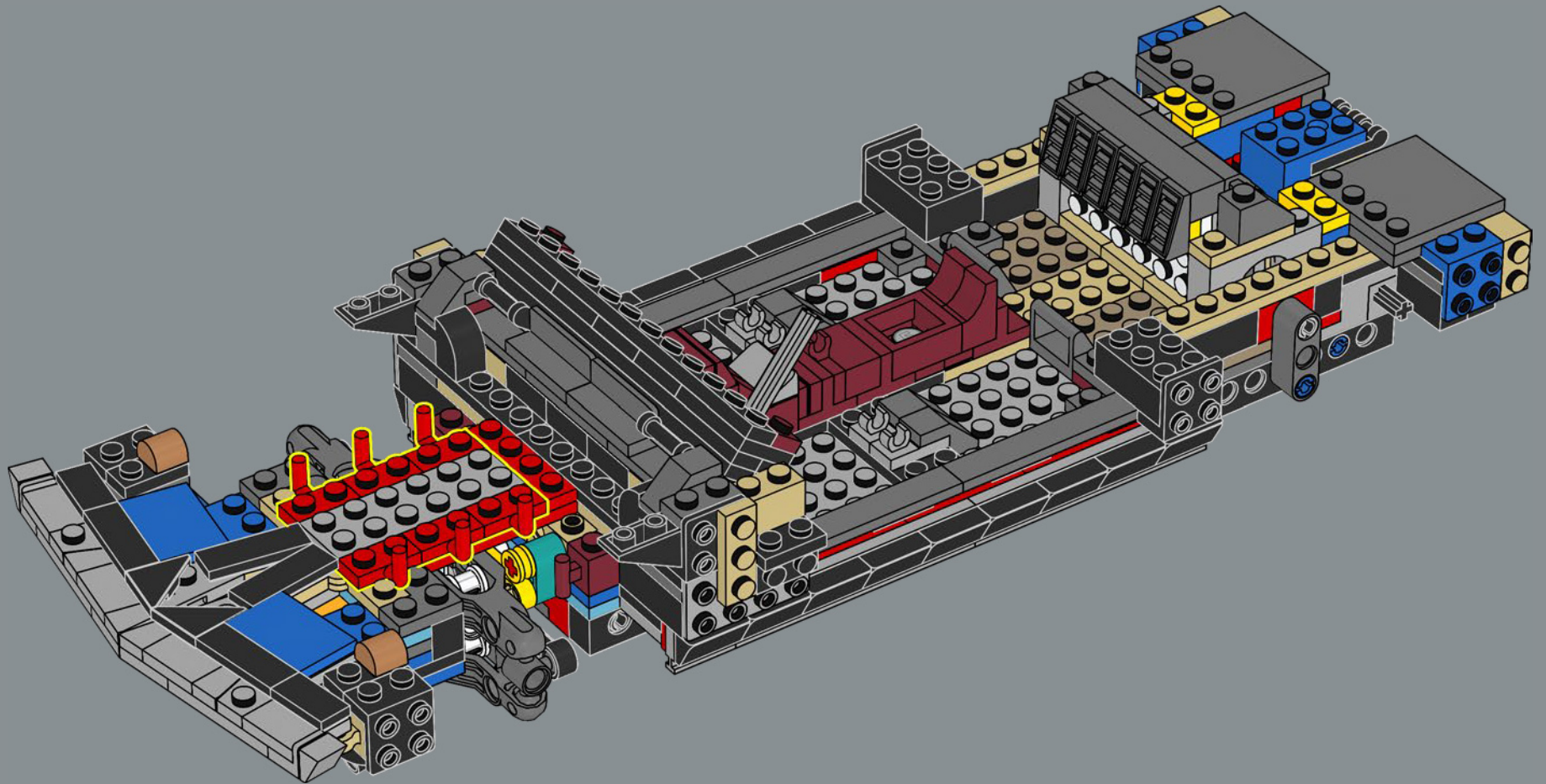

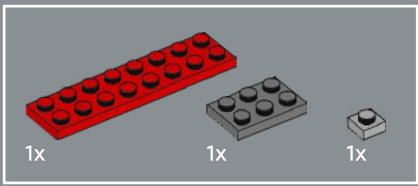

127

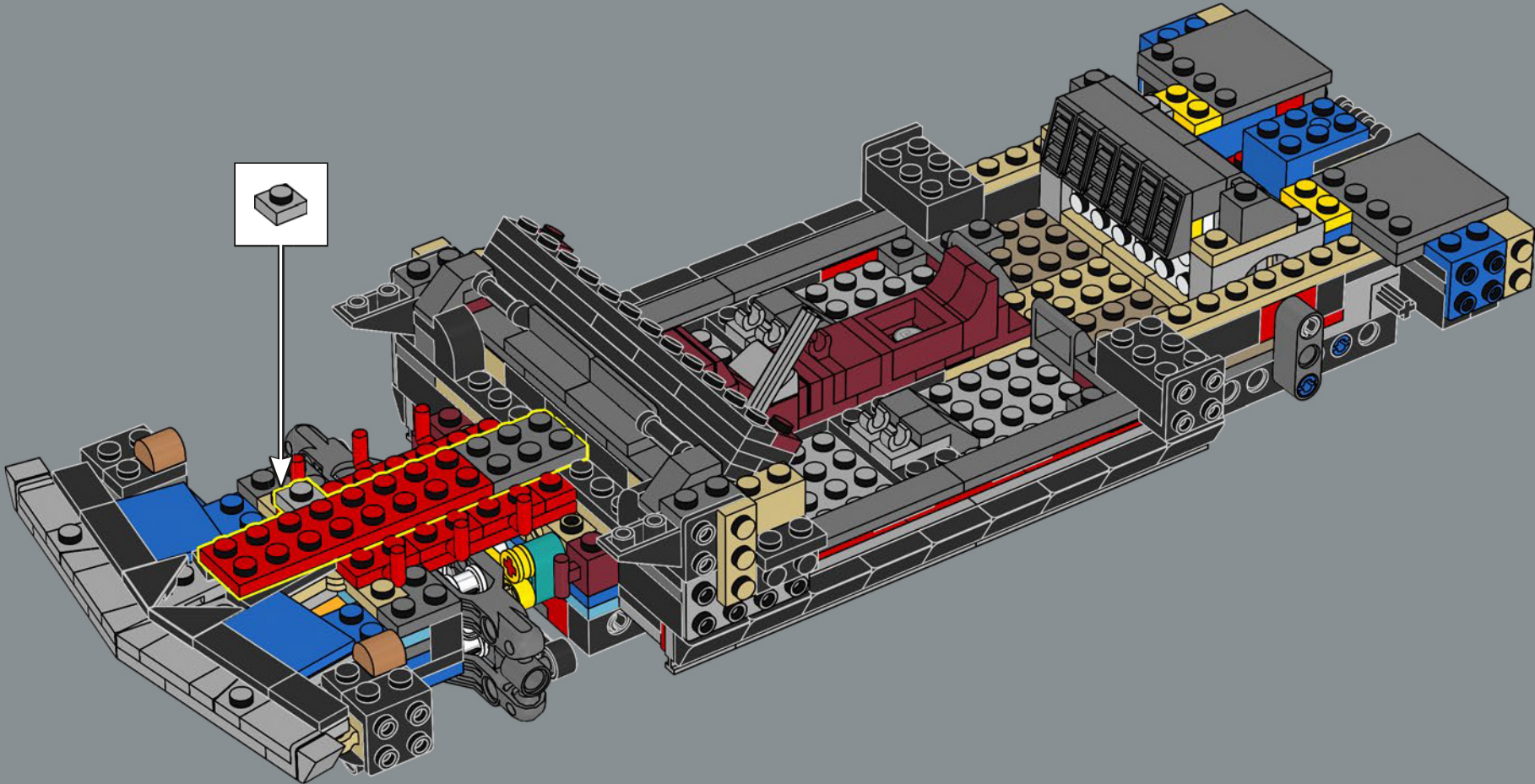

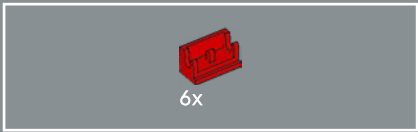

128

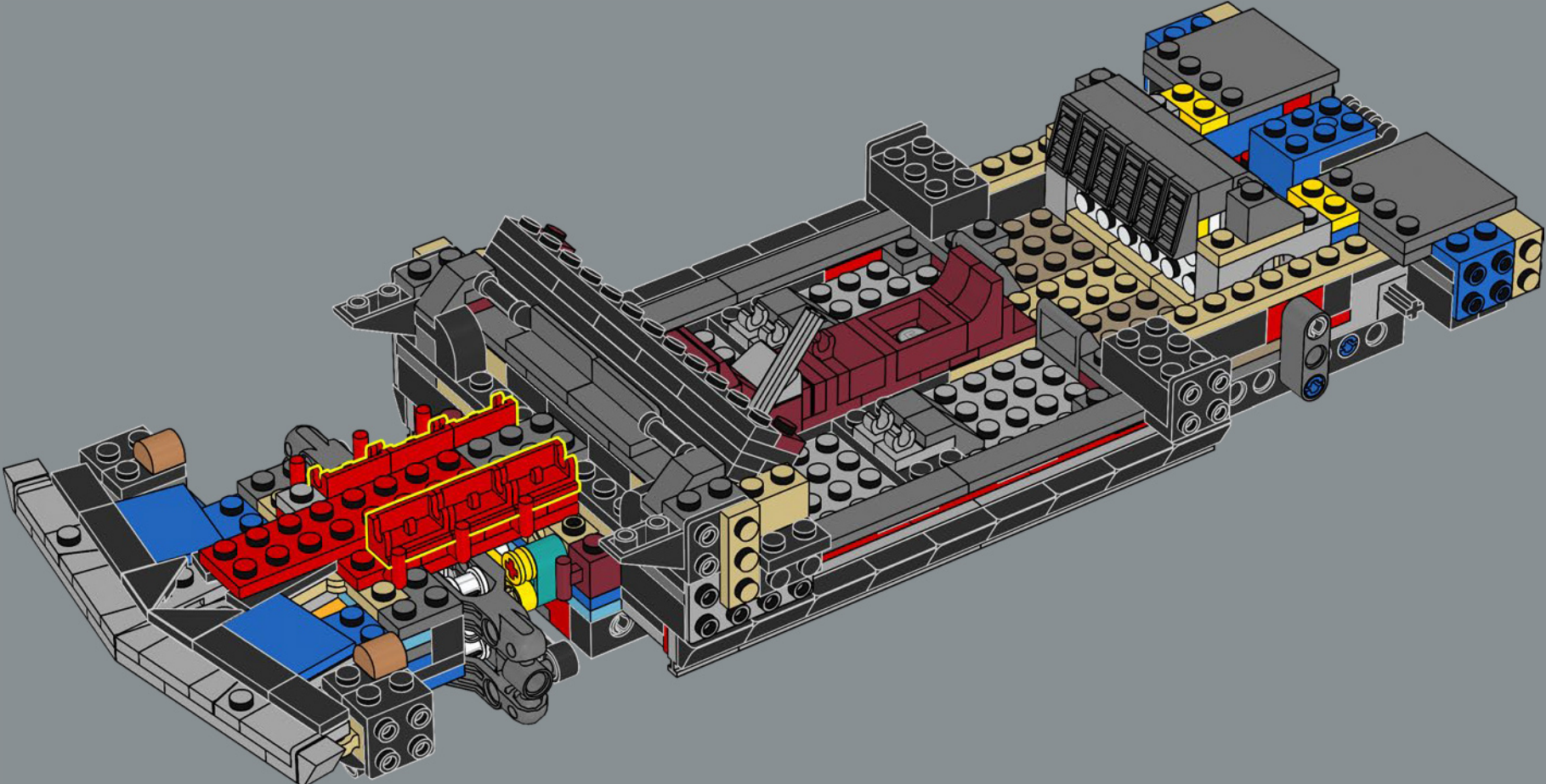

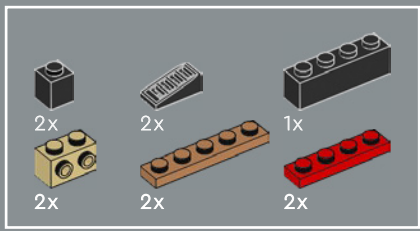

129

1

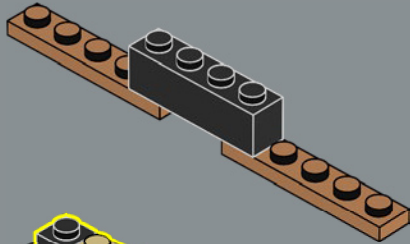

2

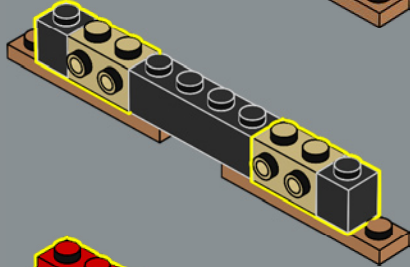

3

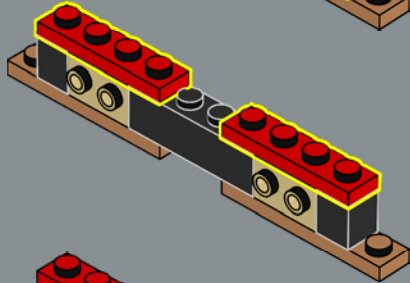

4

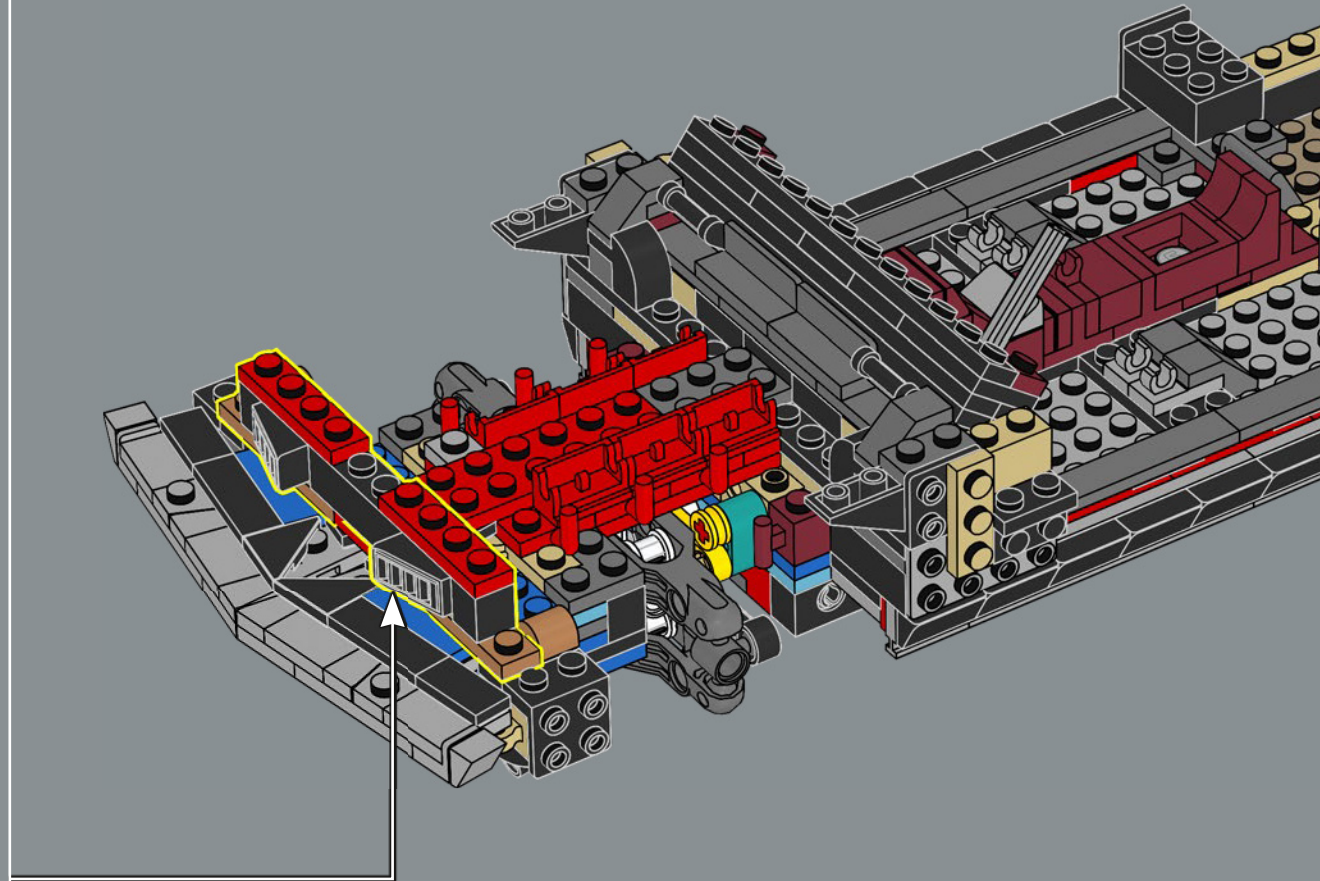
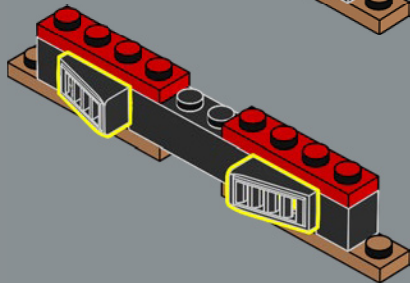

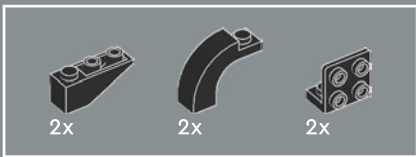

130

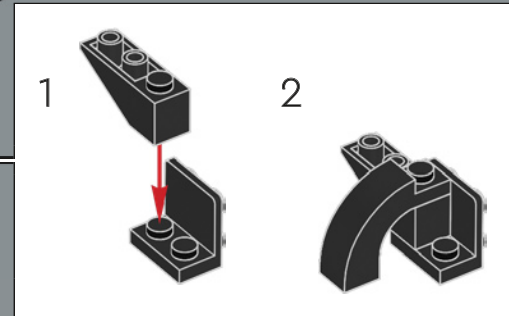
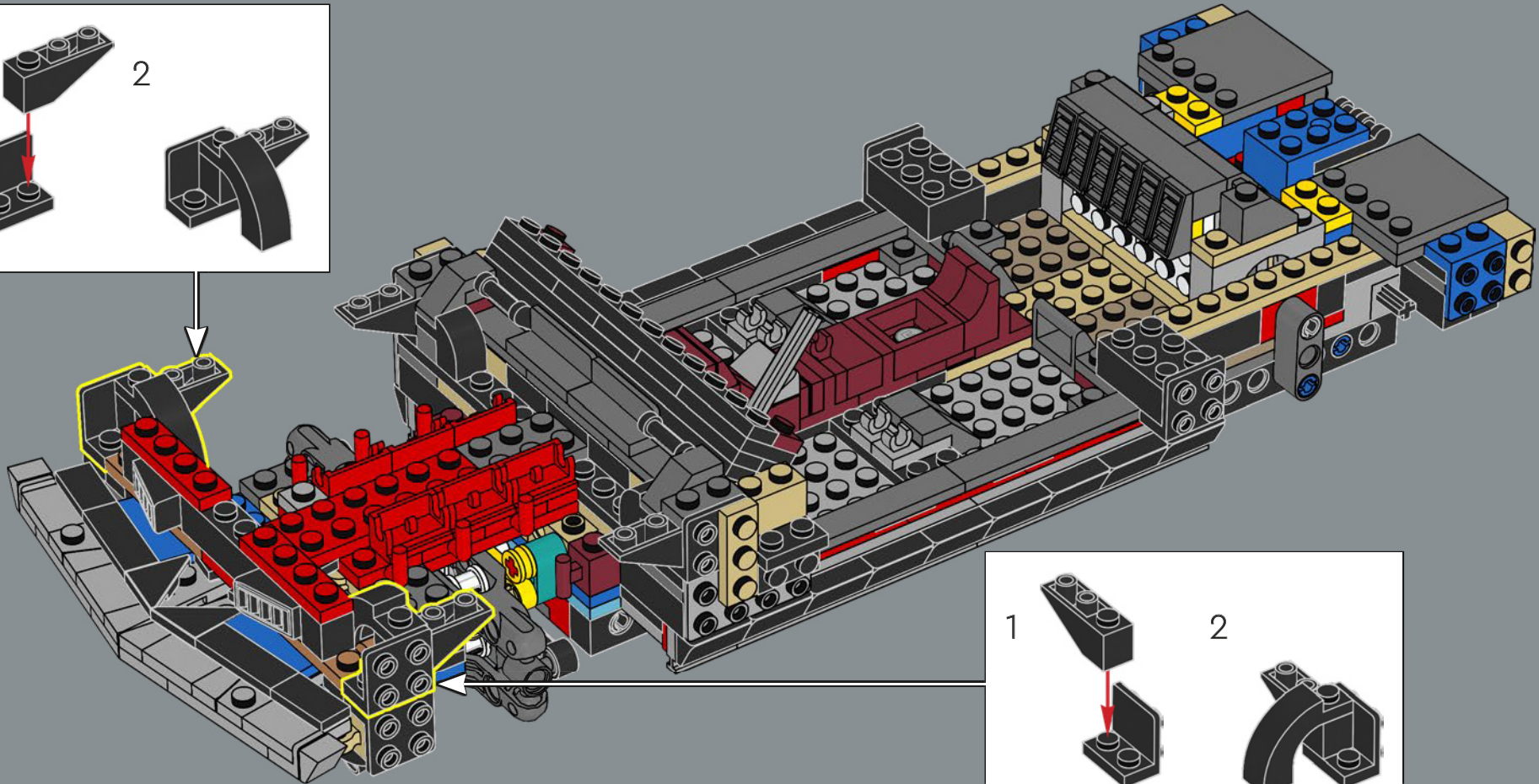
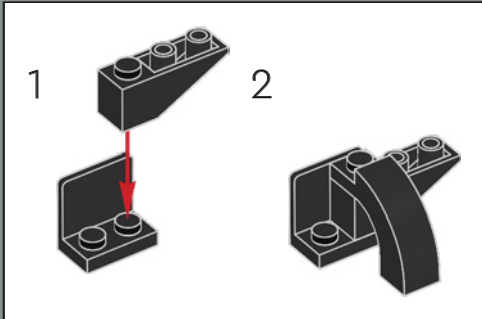

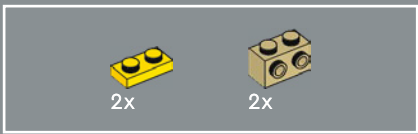

131

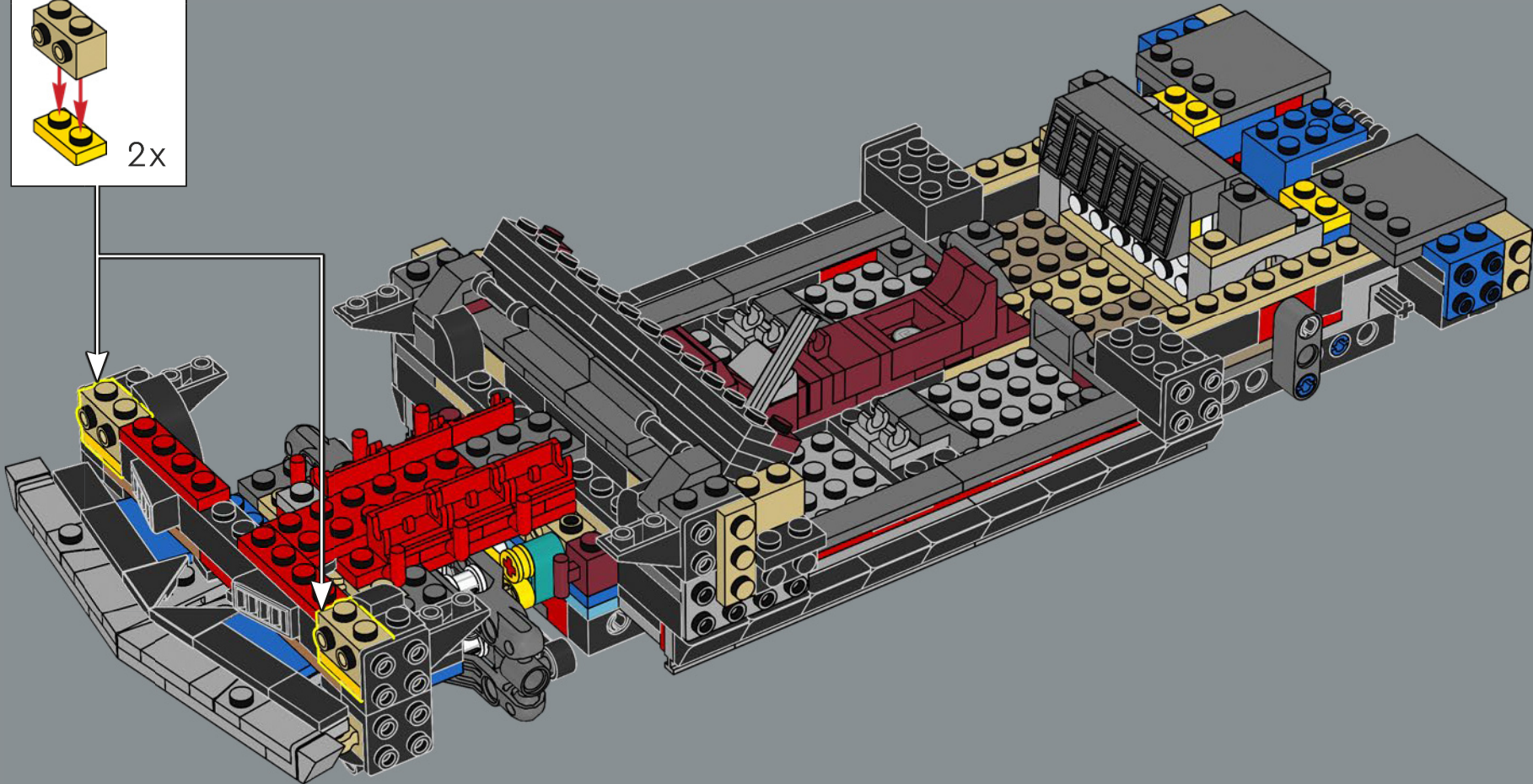
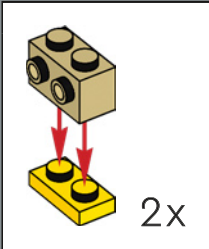

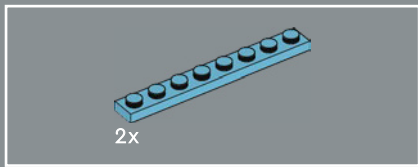

132

À l'occasion de l'annonce de la Chevrolet Camaro à la presse en 1966 a eu lieu la première téléconférence à grande échelle au monde, avec plus de 200 journalistes de 14 villes américaines.

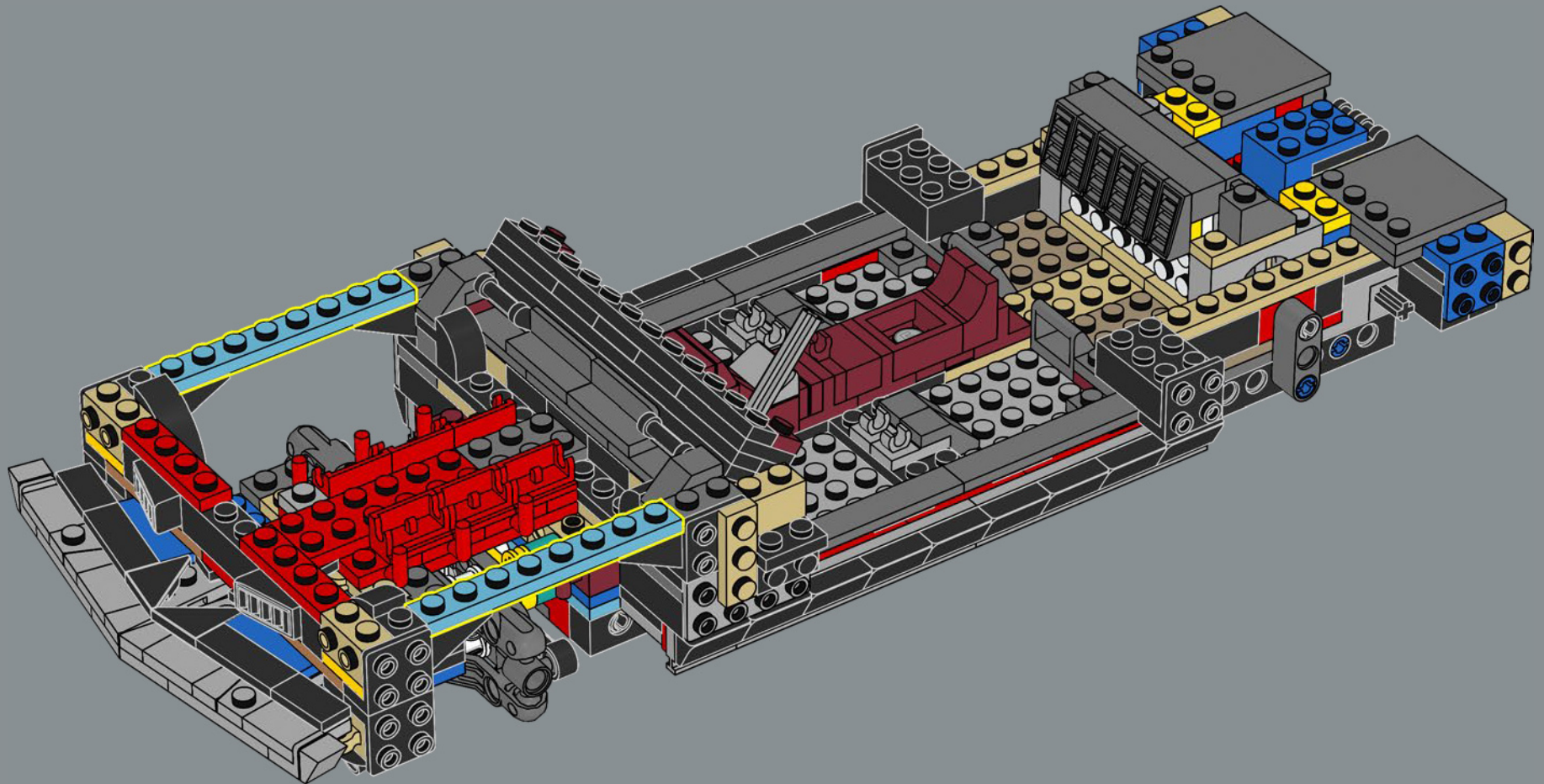



133

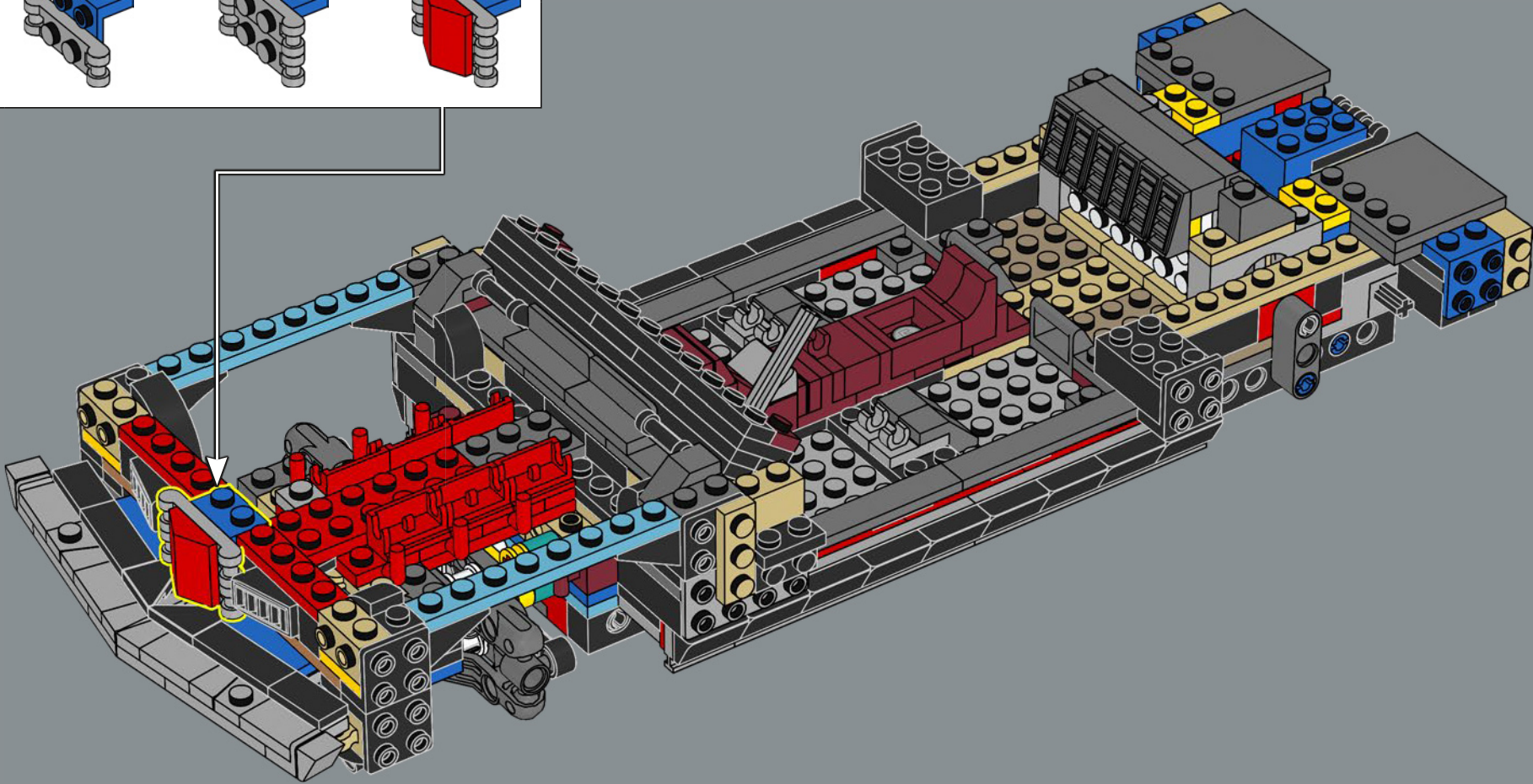
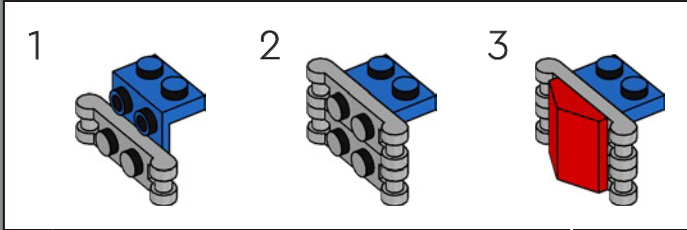



134

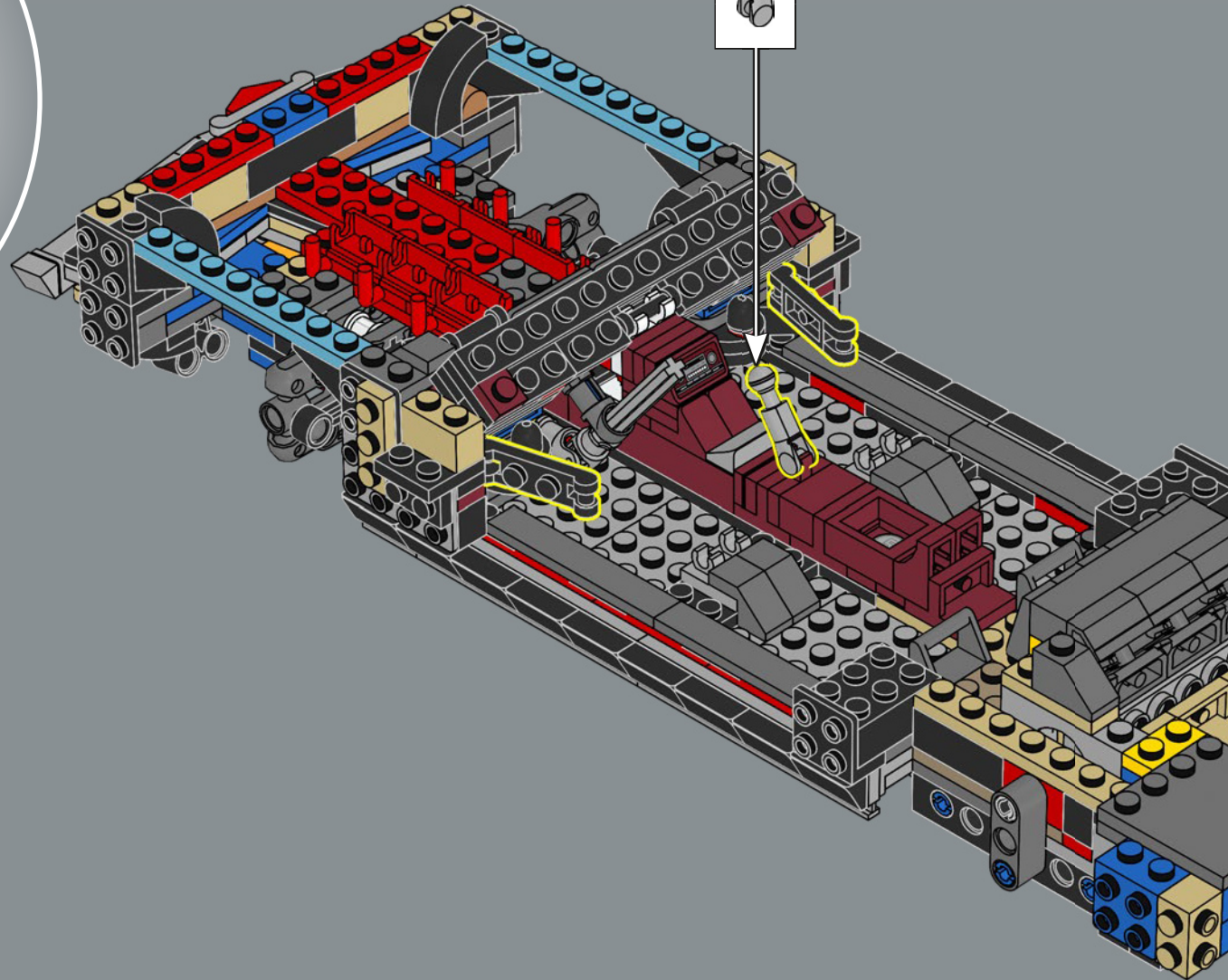
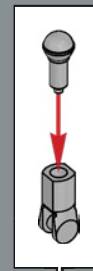

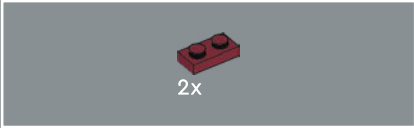
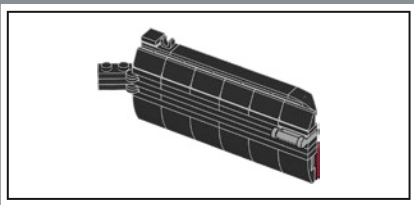

2x

135

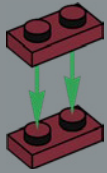

1x

136

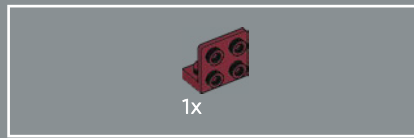
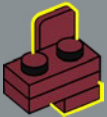

1x

137

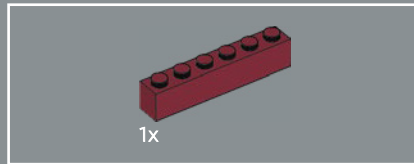
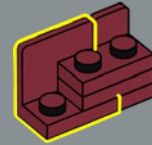

1x

138

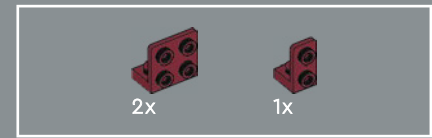
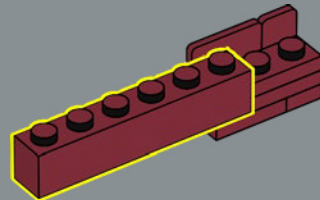

2x

1x

139

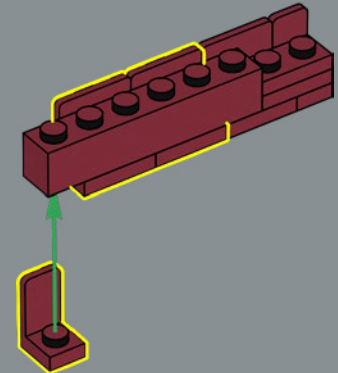



140

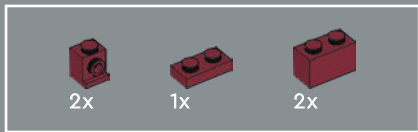
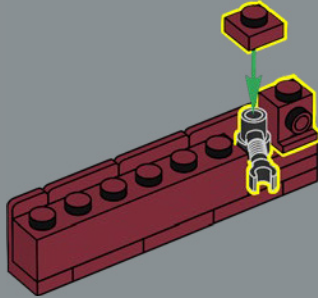

141

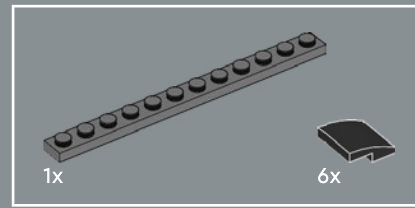
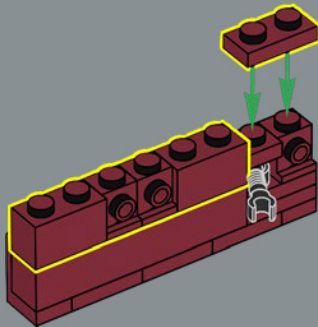

142

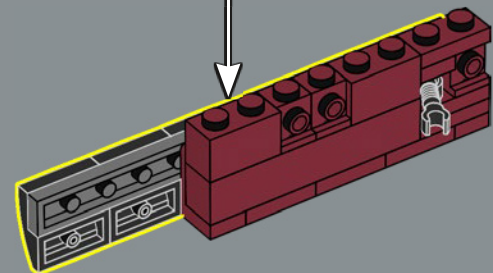
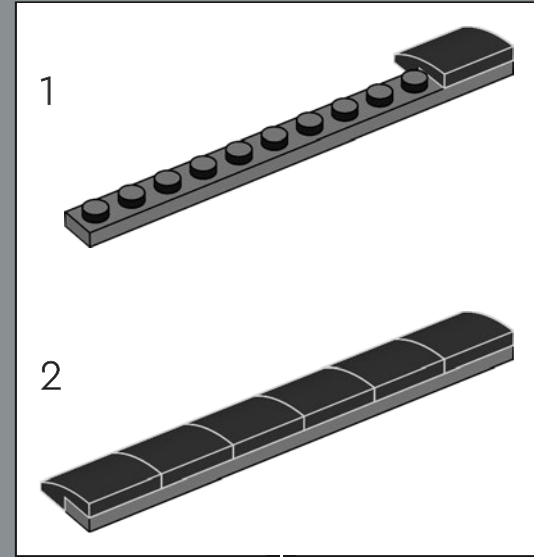

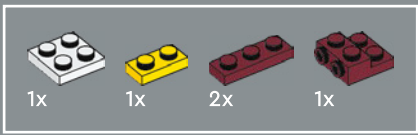

143

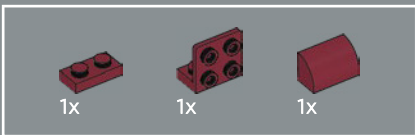
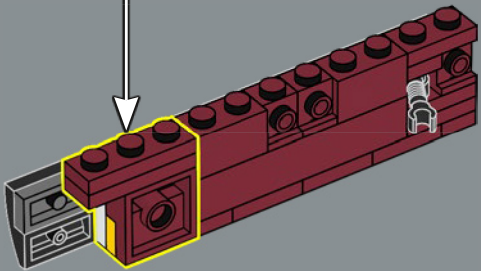
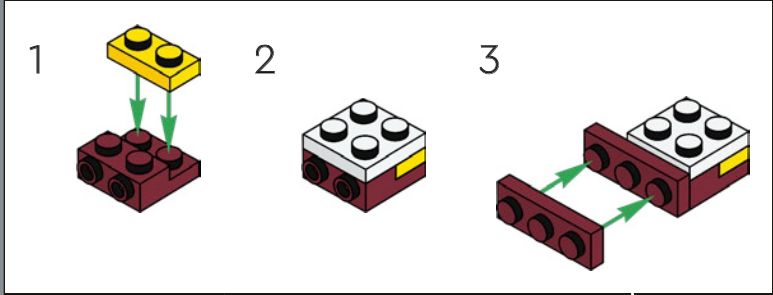

144

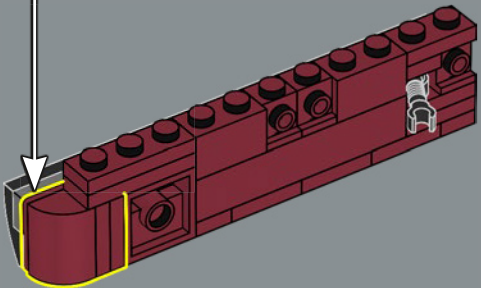
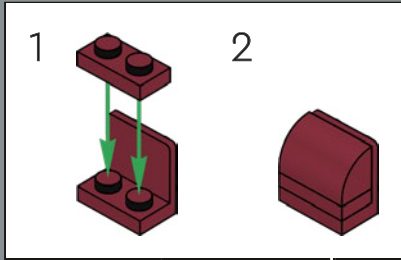

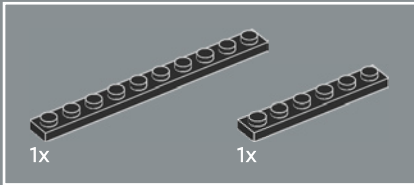
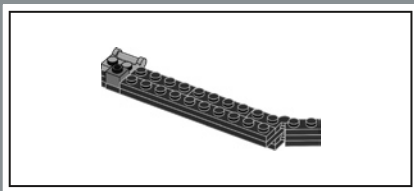

145

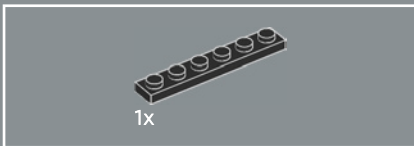
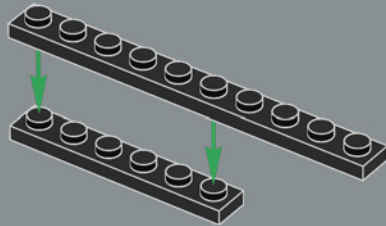

146

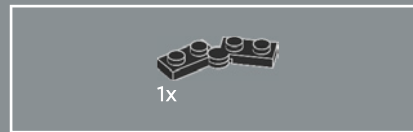
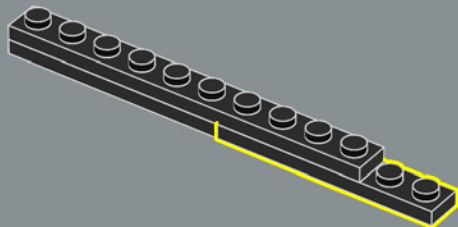

147

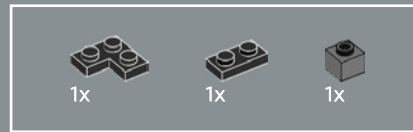
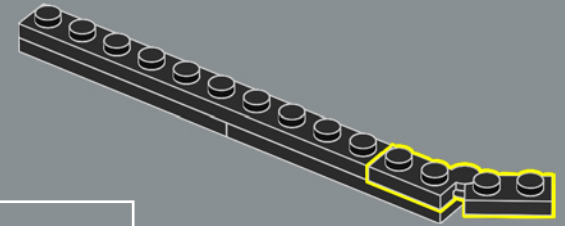

148

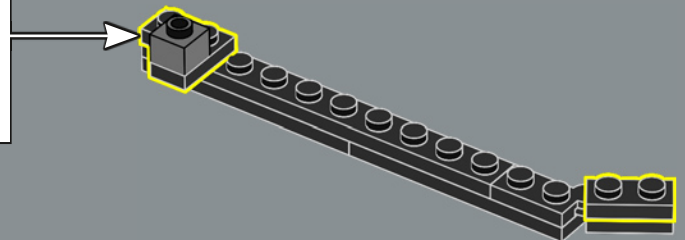
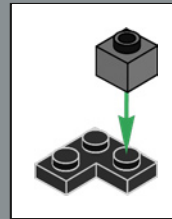

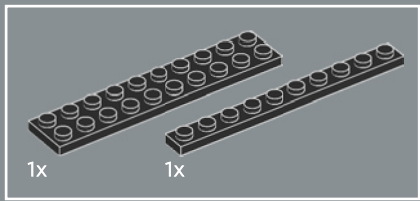

149

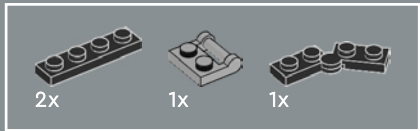
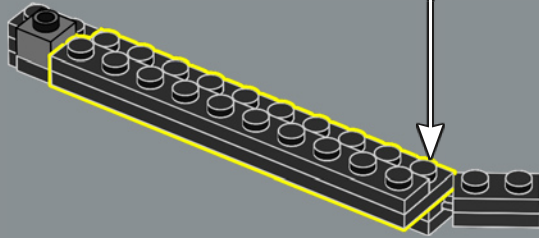
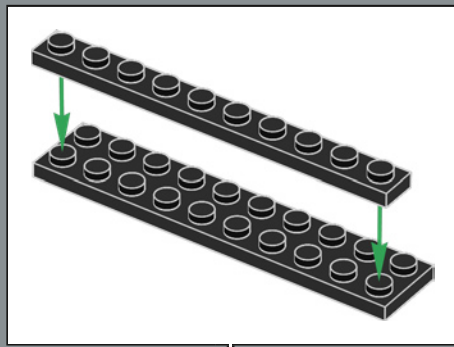

150

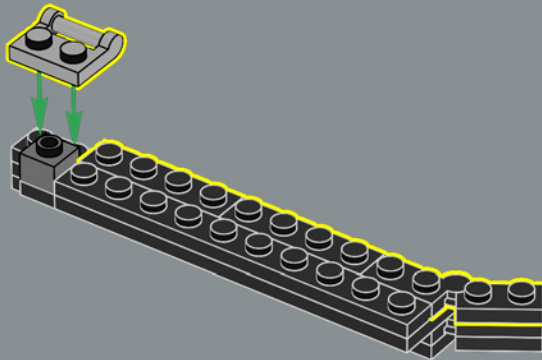

151

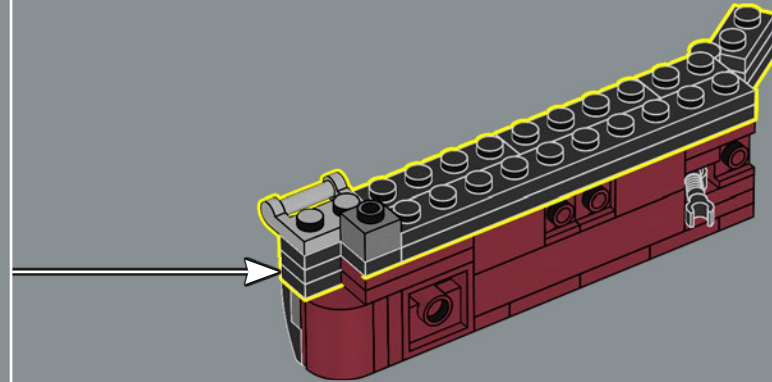

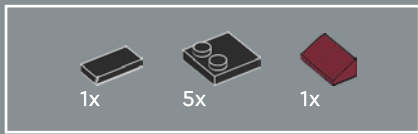

152

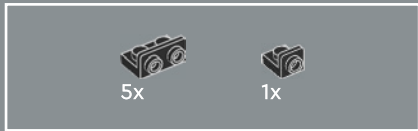
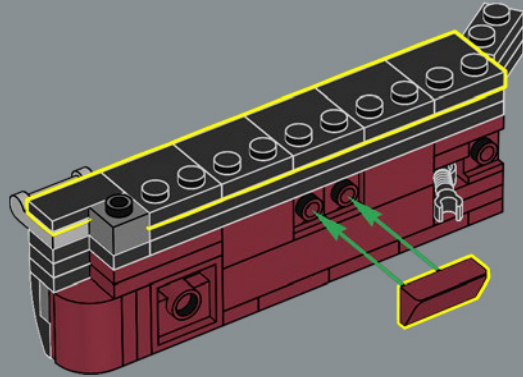

153

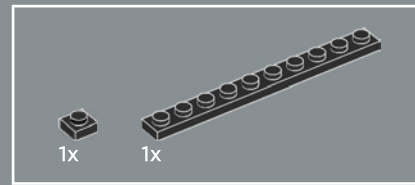
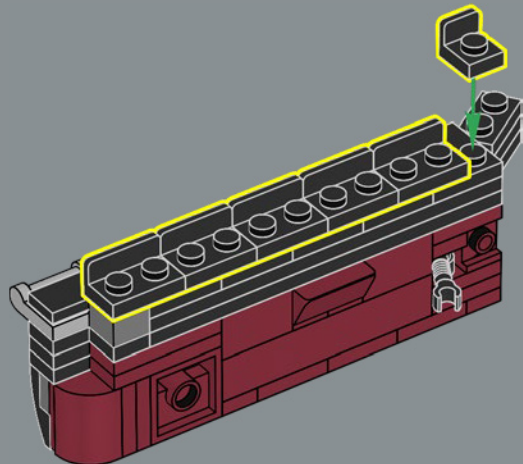

154

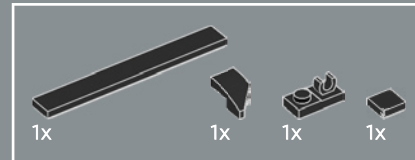
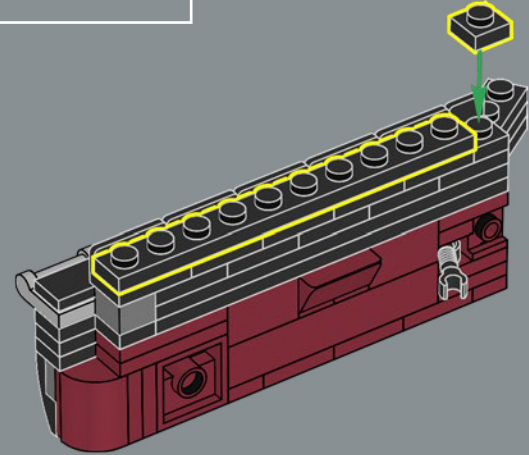

155

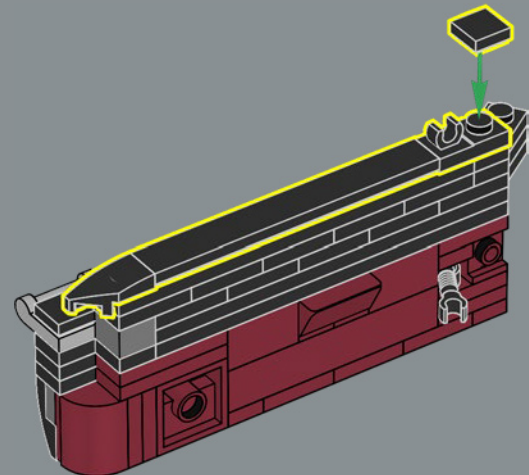



6x

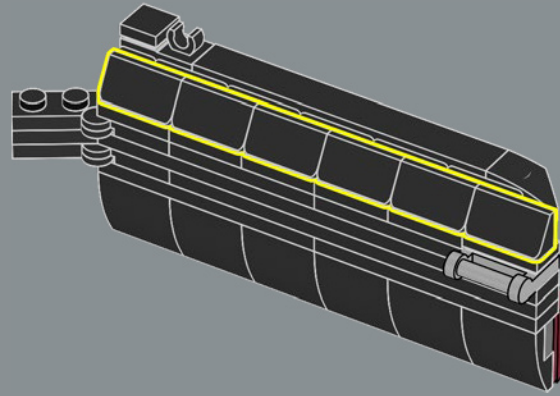

156

157

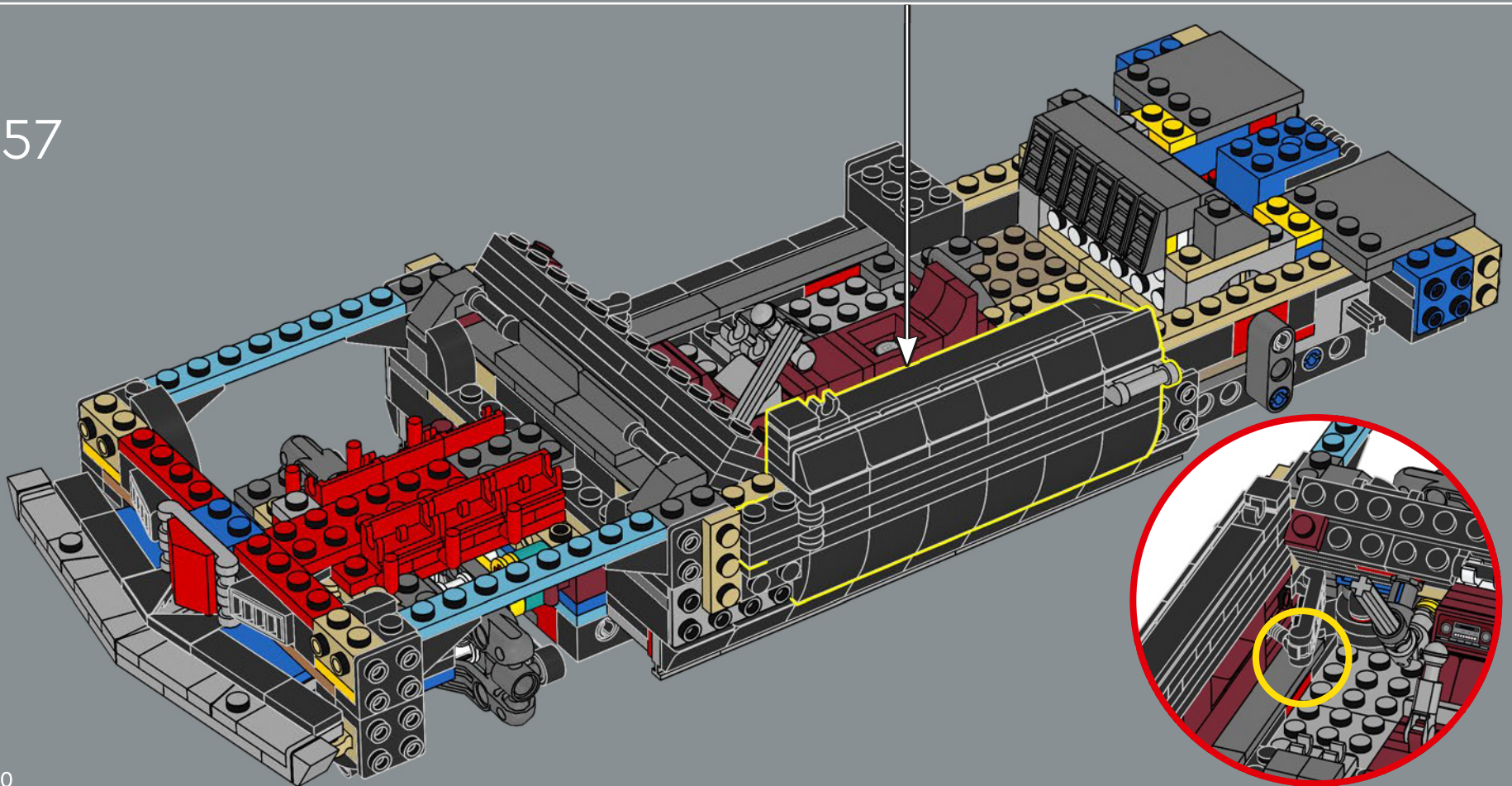



158

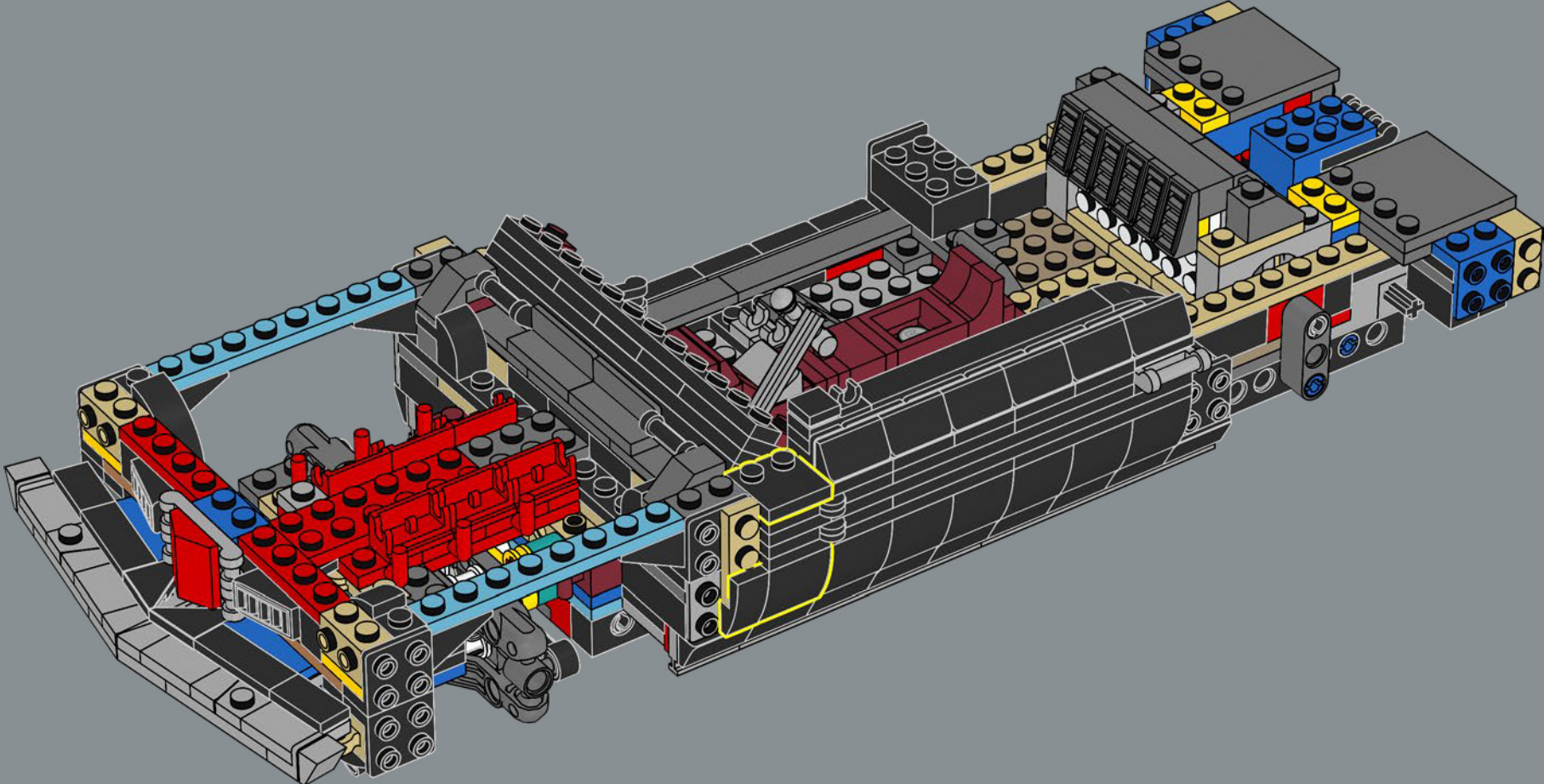

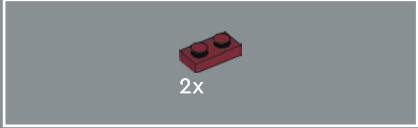
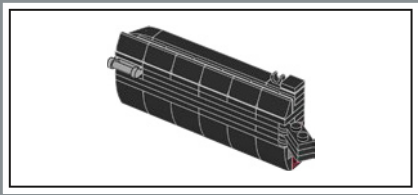

159

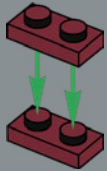

160

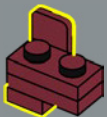

161

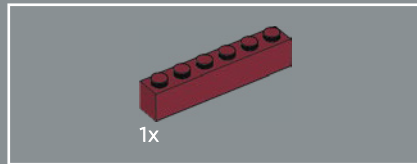
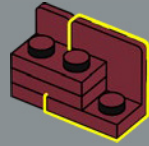

162

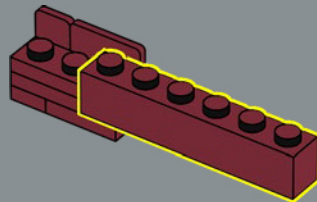

163

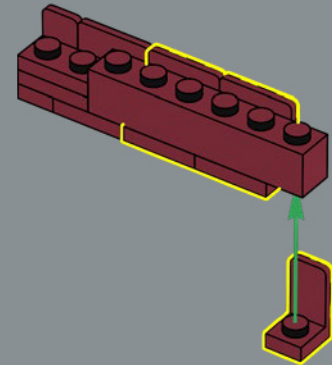



164

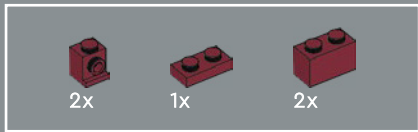
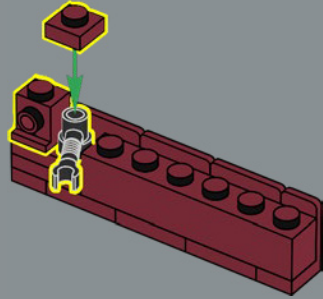

165

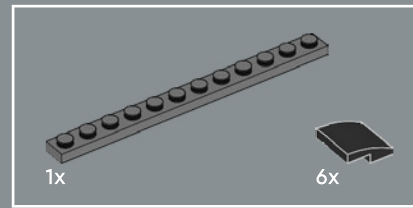
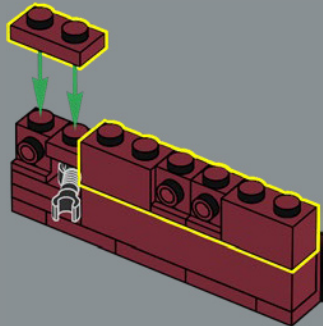

166

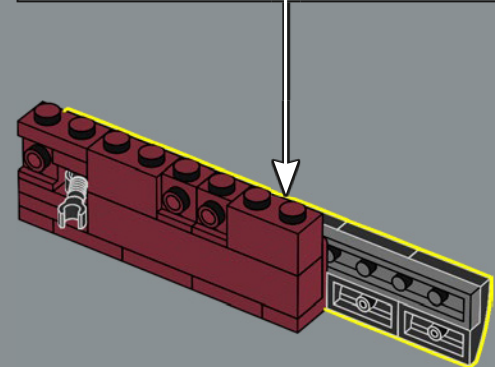
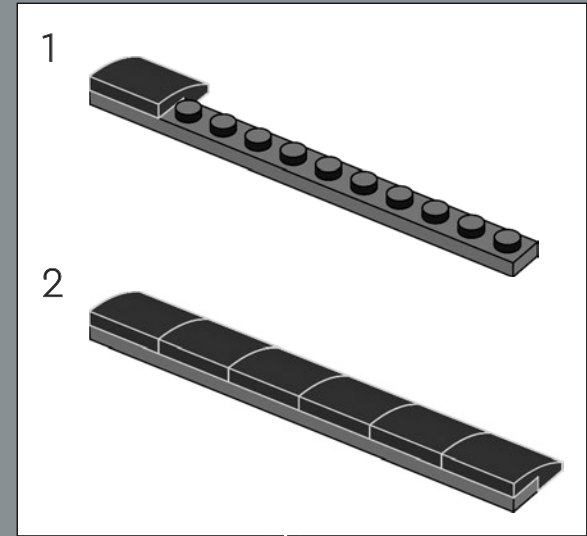

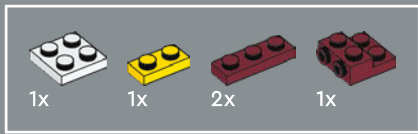

167

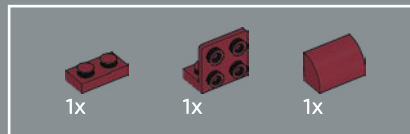
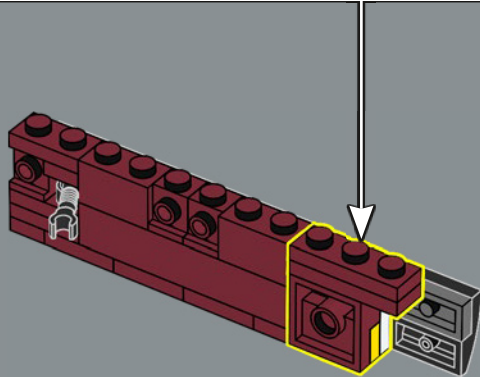
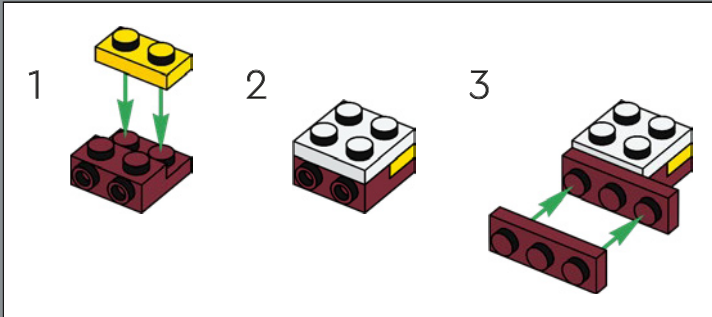

168

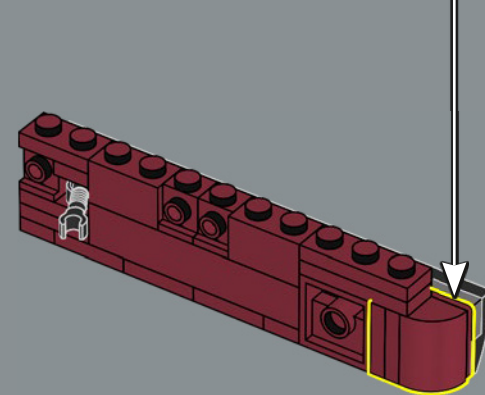
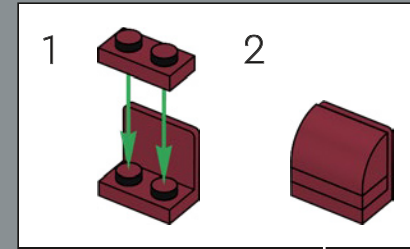

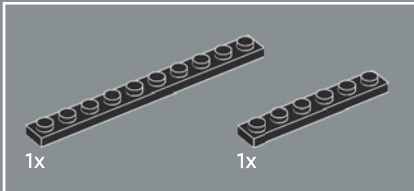
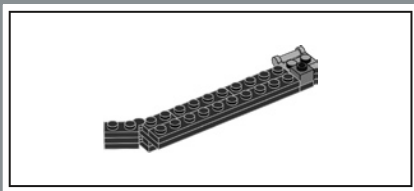

169

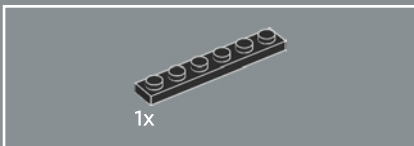
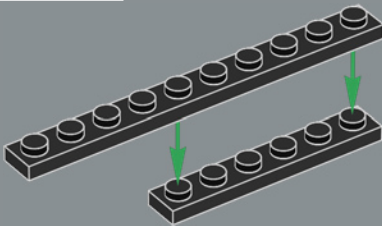

170

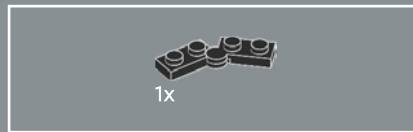
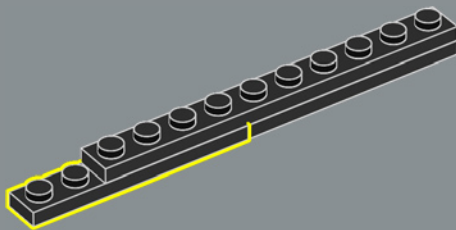

171

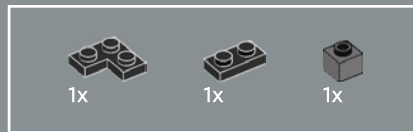
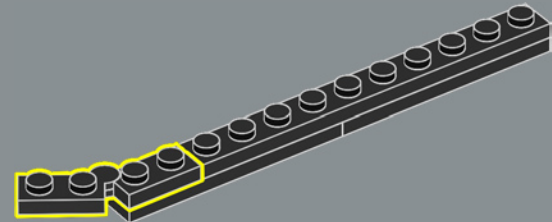

172

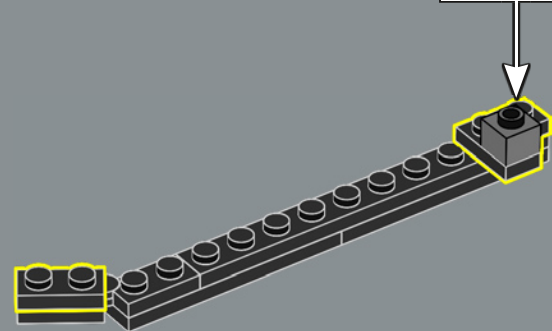
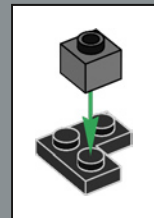

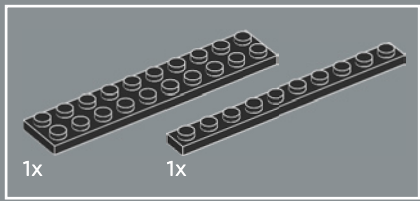

173

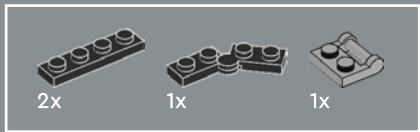
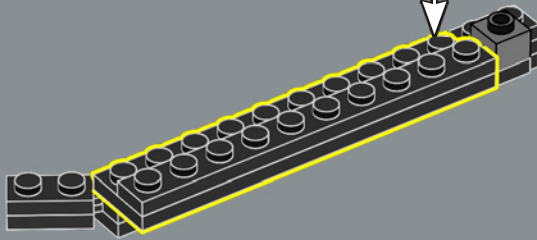
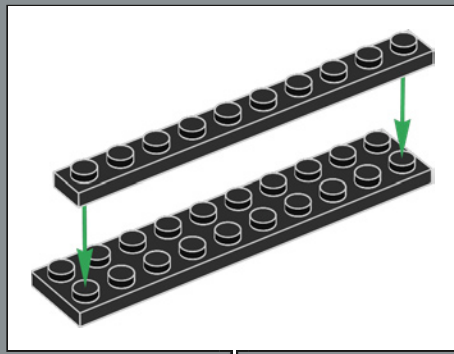

174

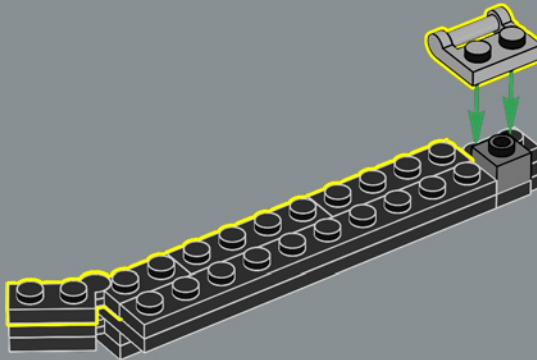

175

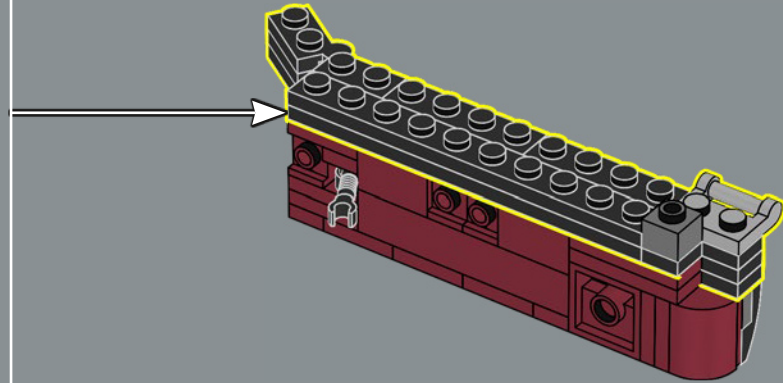

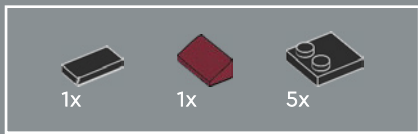

176

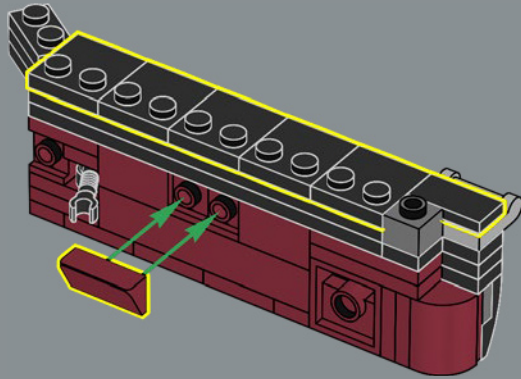

177

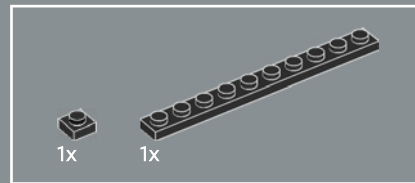
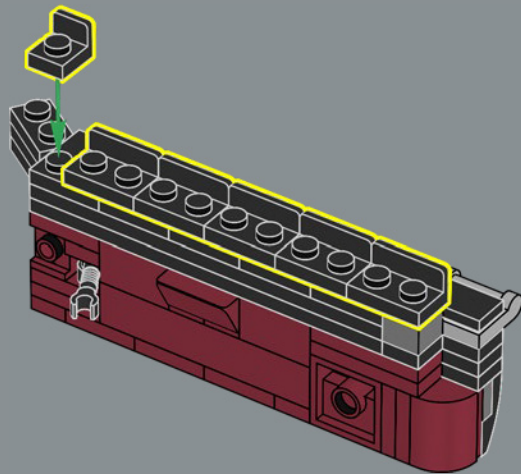

178

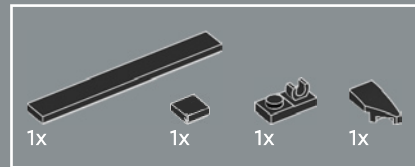
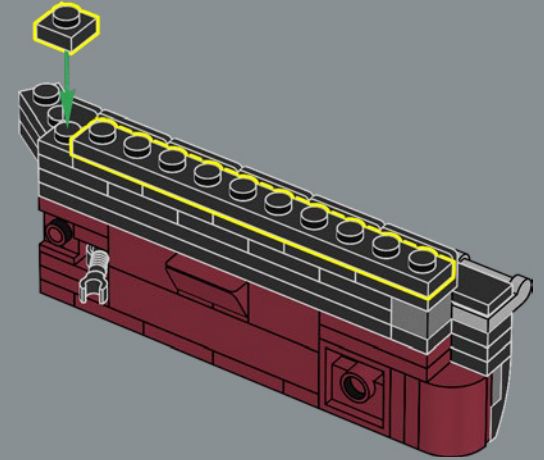

179

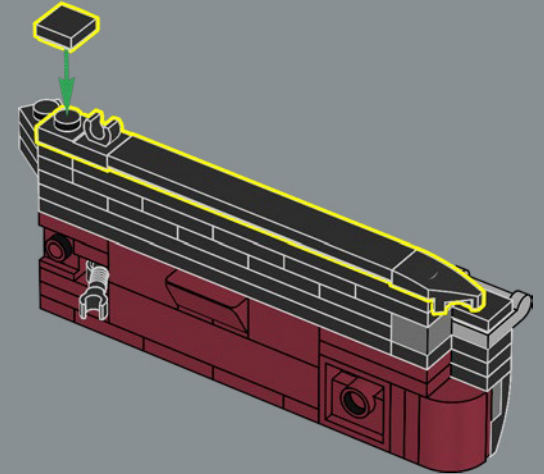



6x

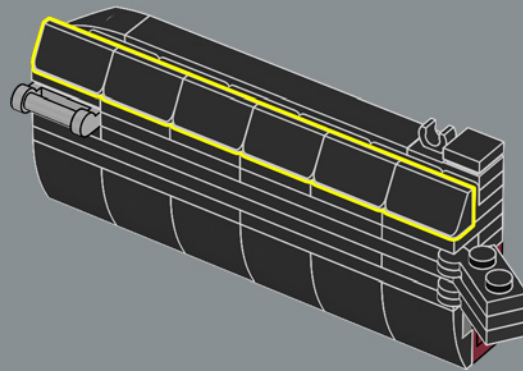

180

181

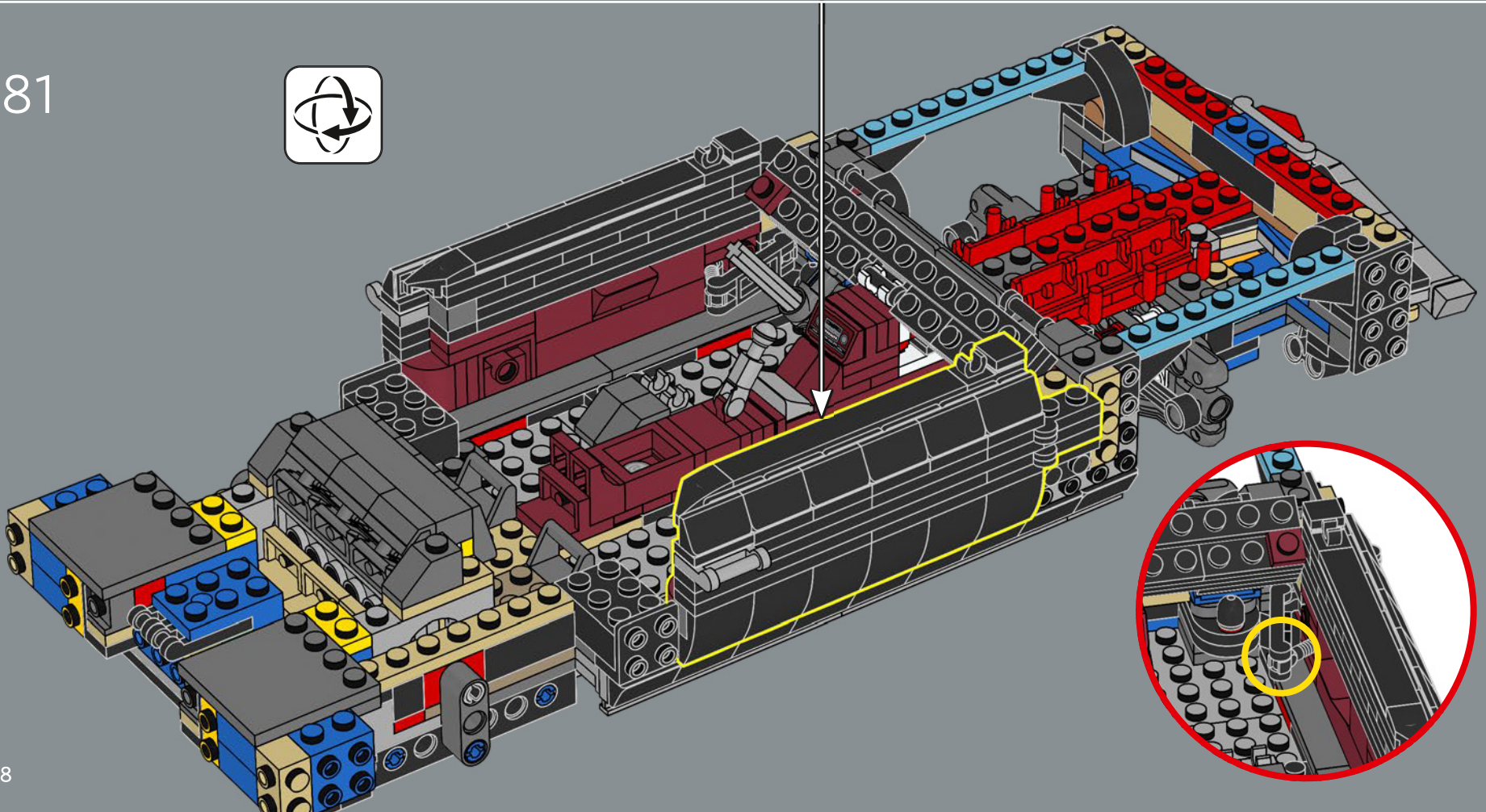



182

Au départ, les acheteurs de Camaro avaient le choix entre 80 options d'usine différentes.

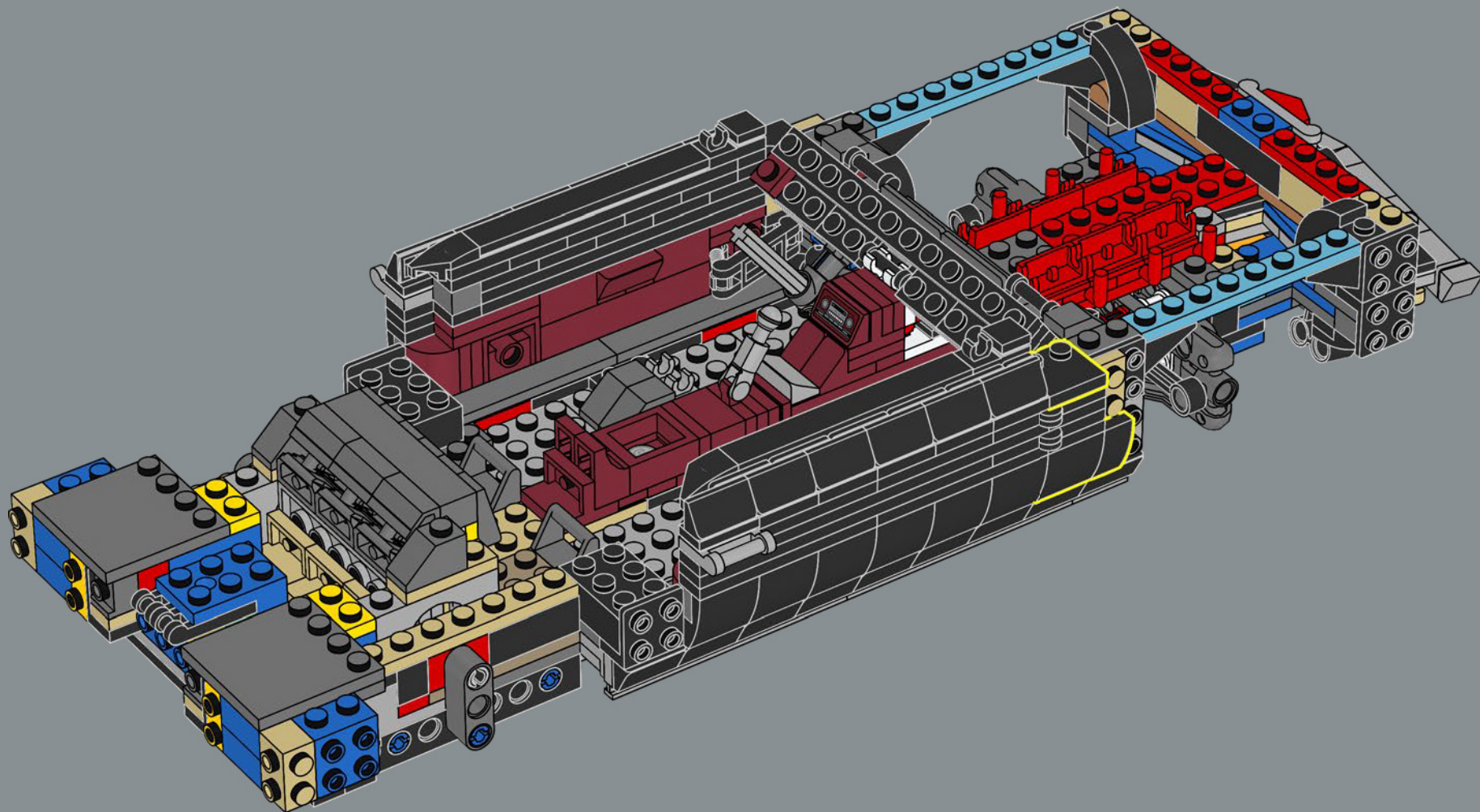

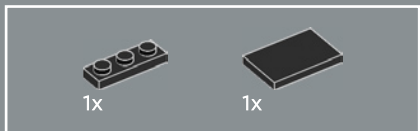

183

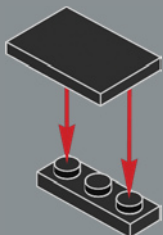

184

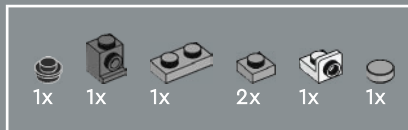
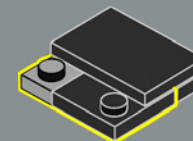

185

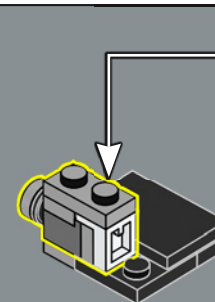
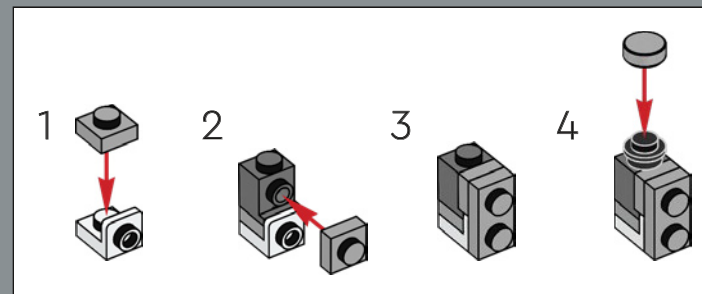

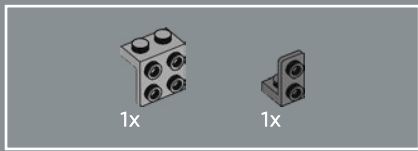

186

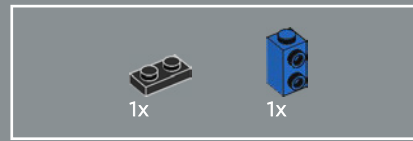
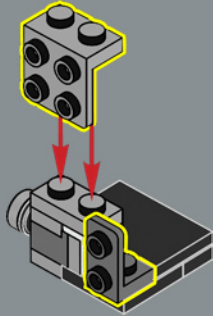

187

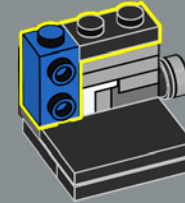

188

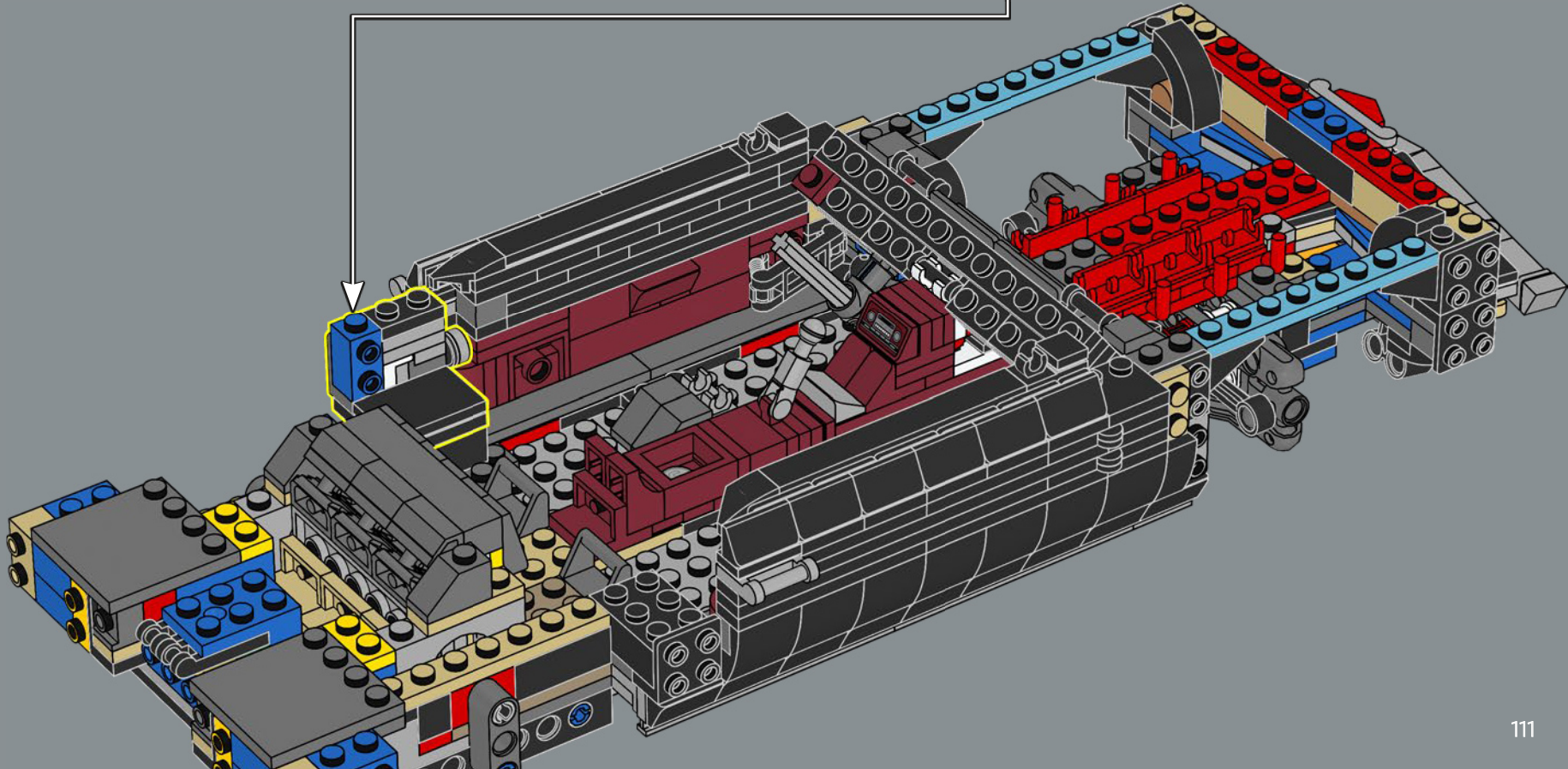

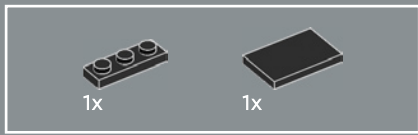

189

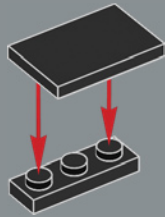

190

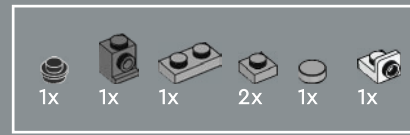
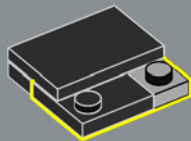

191

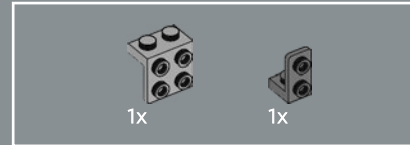
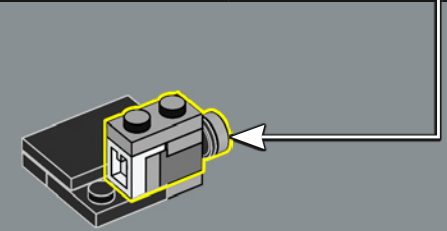
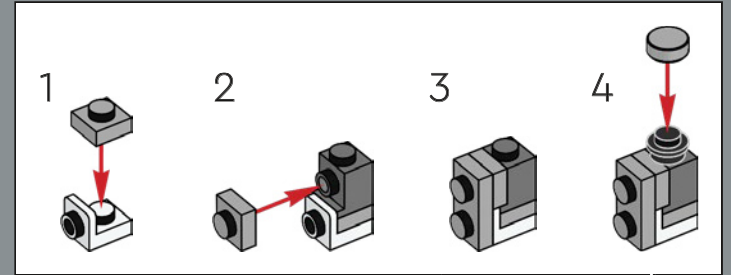

192

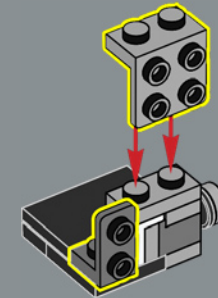

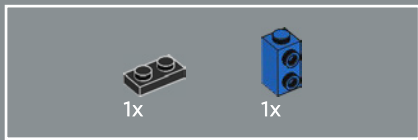

193

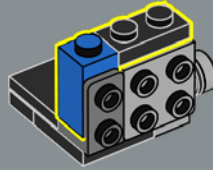

194

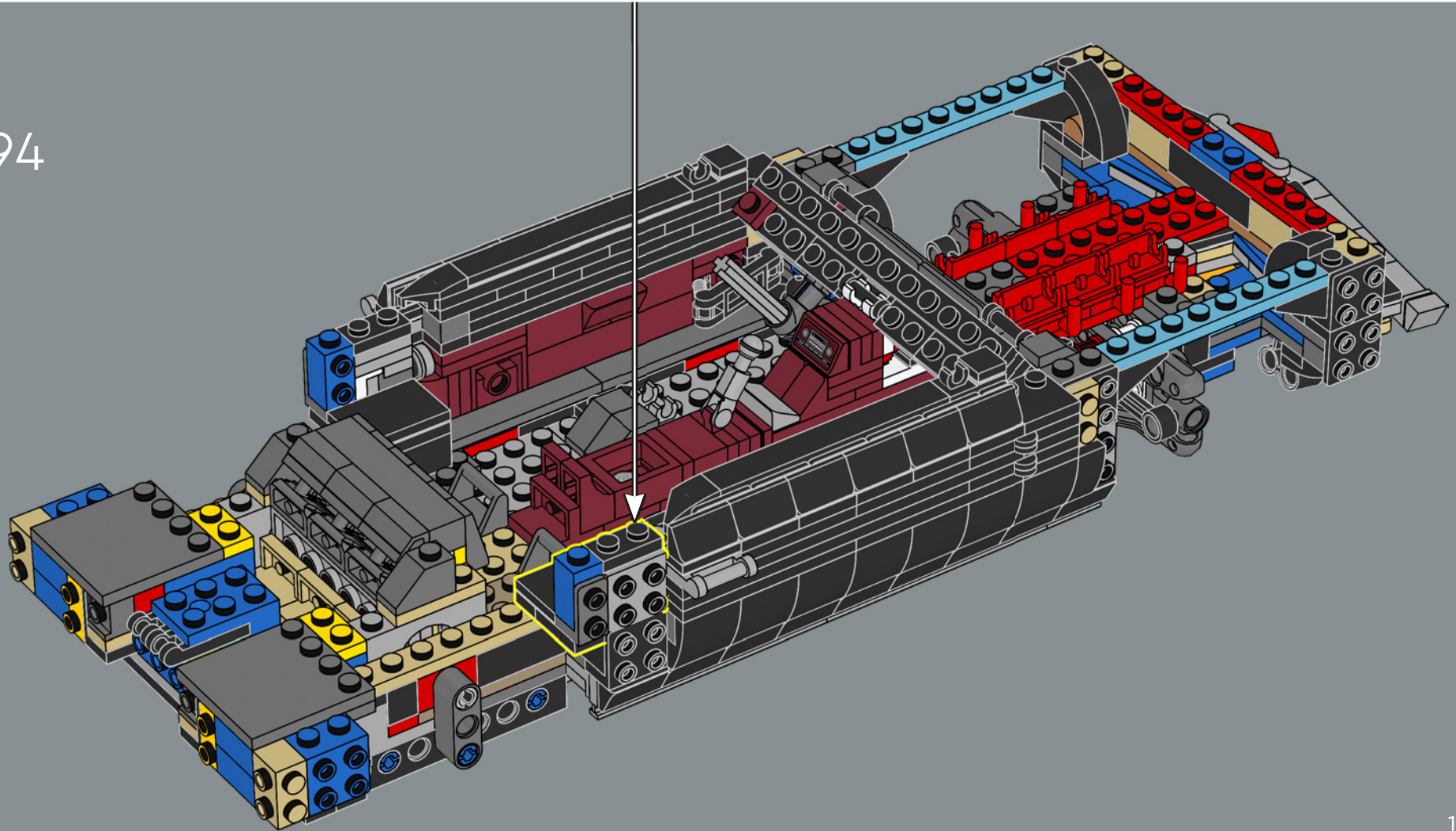

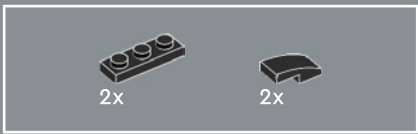

195

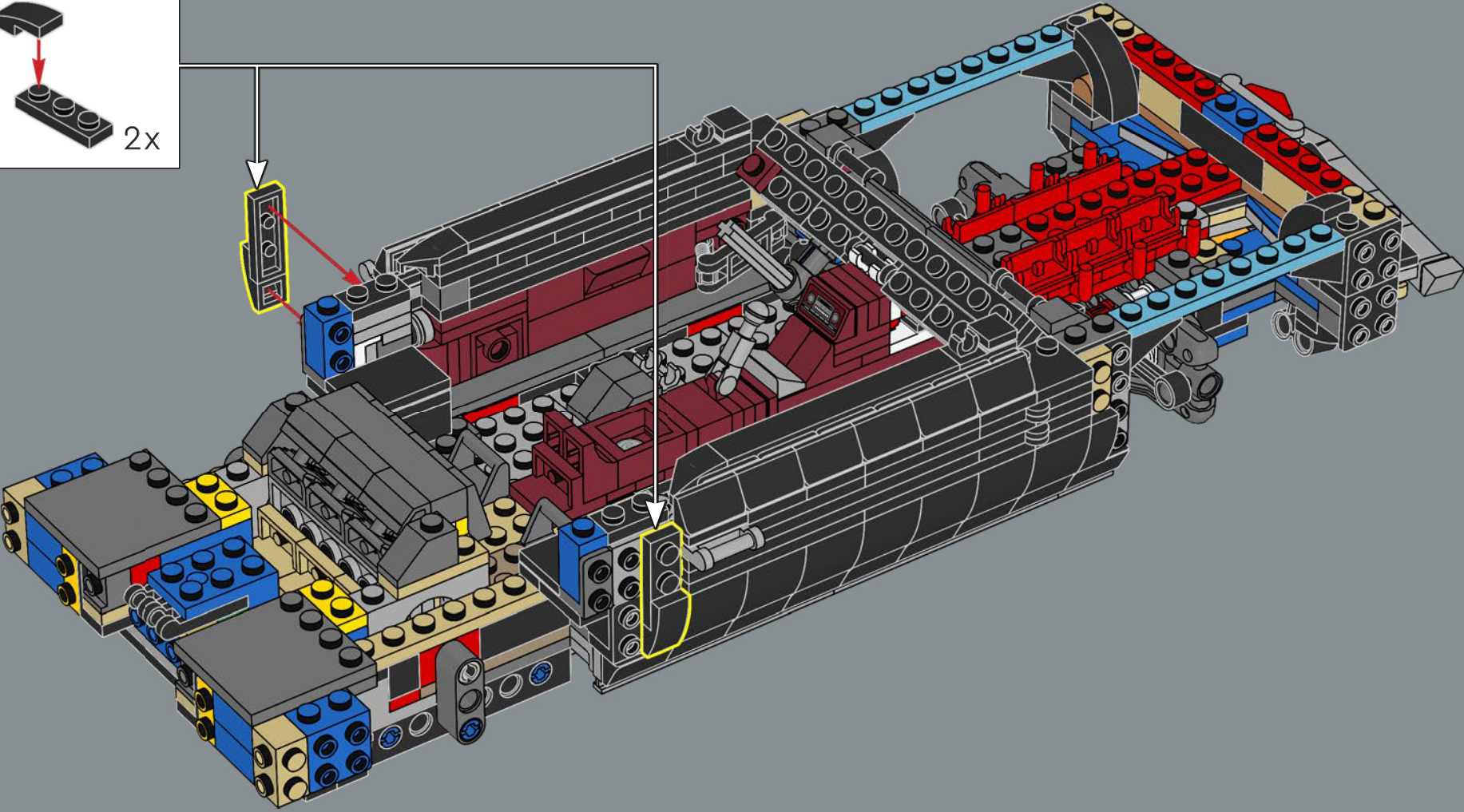
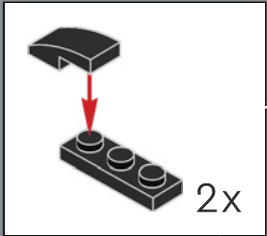

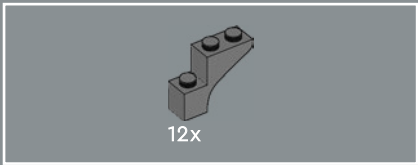

196

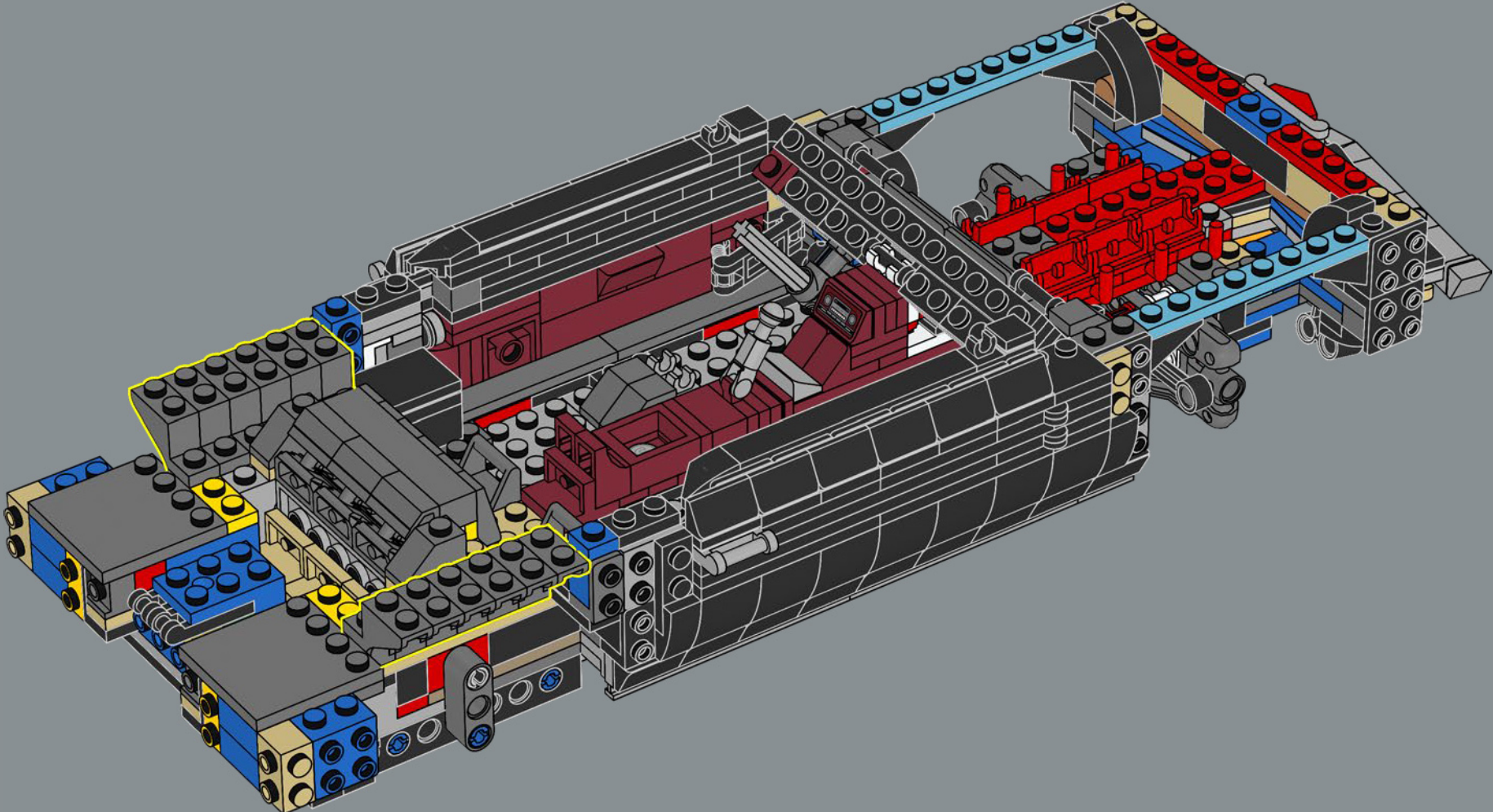

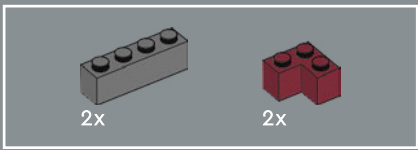

197

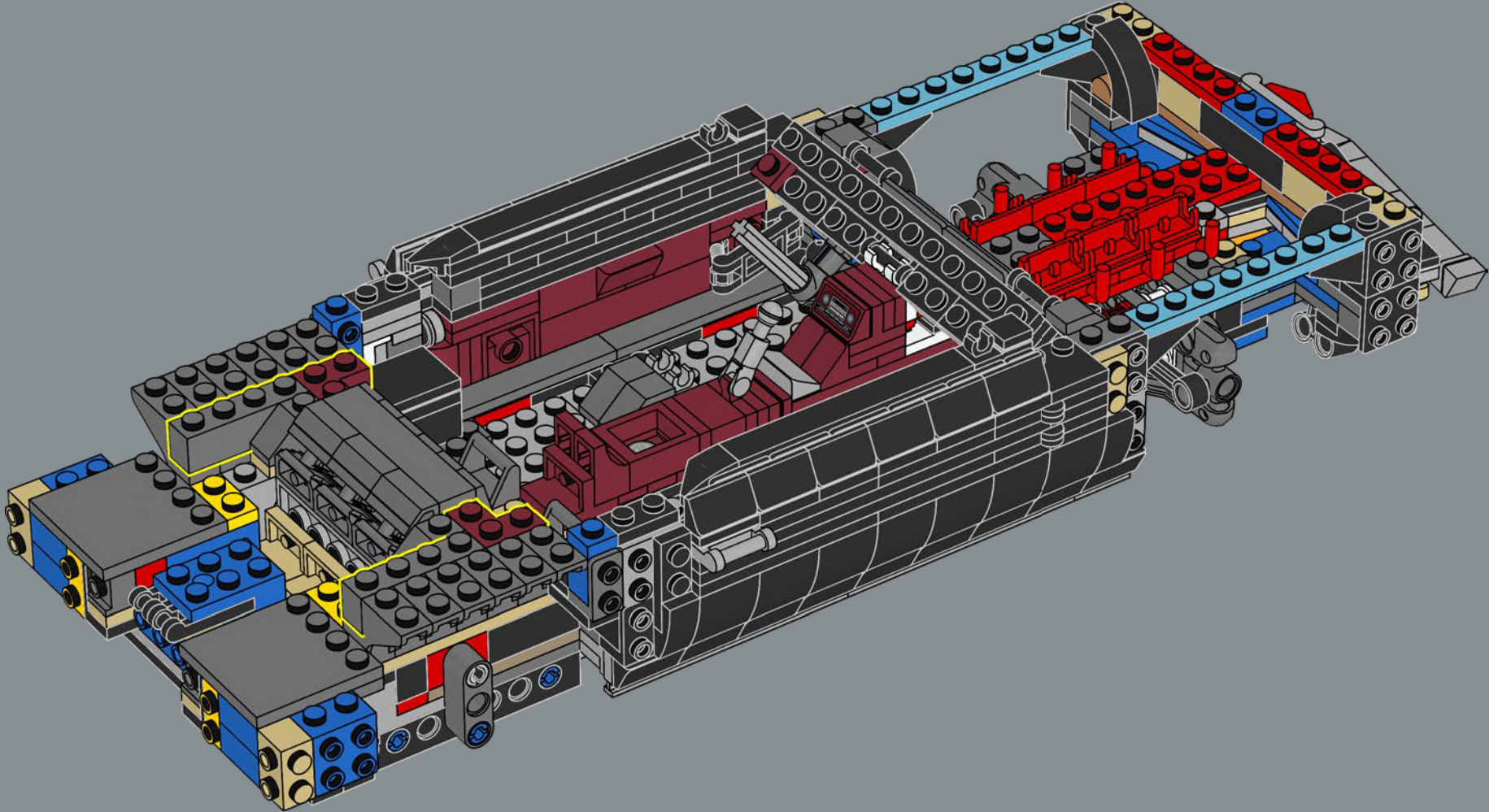

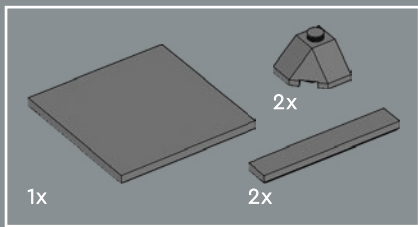

198

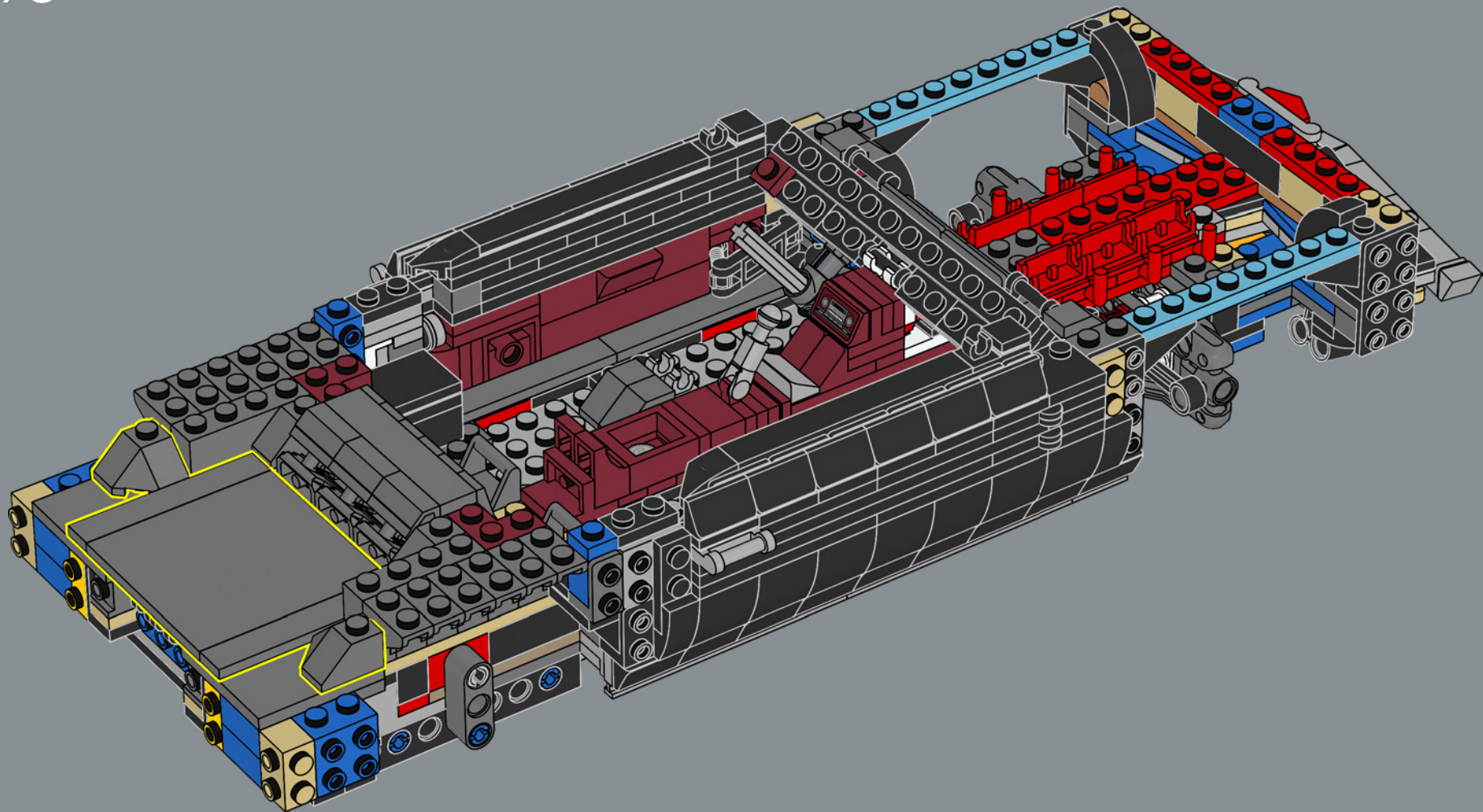

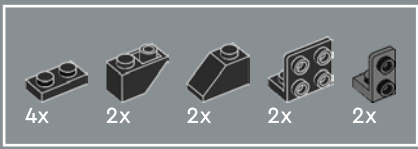

199

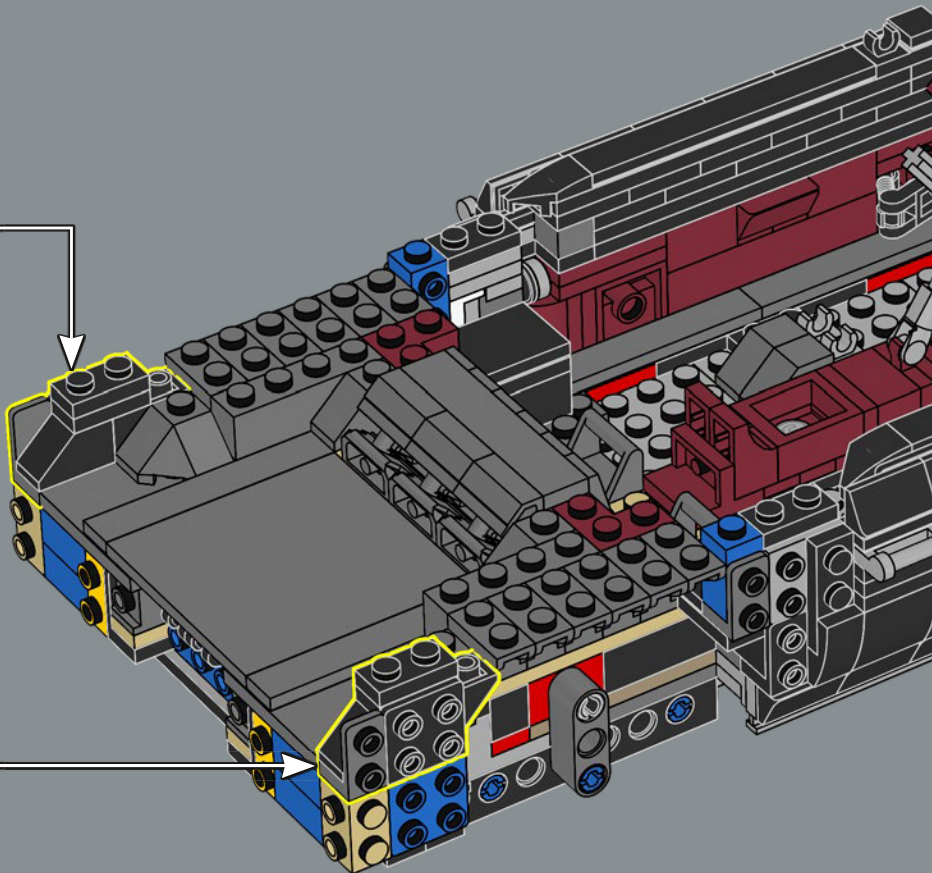
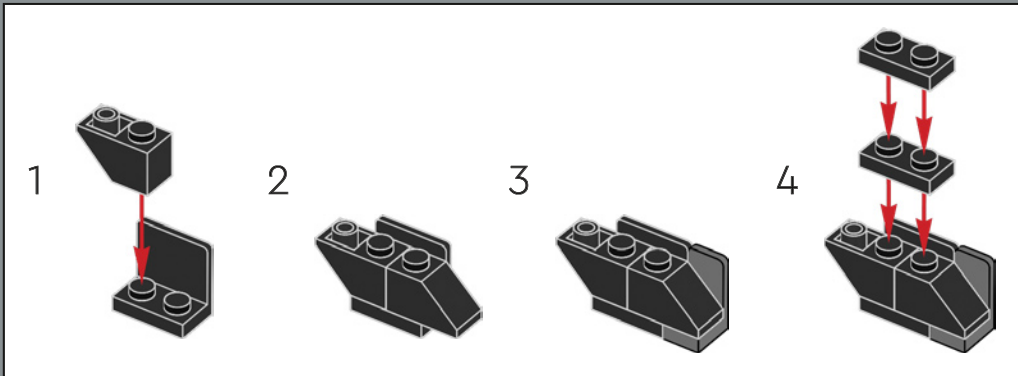
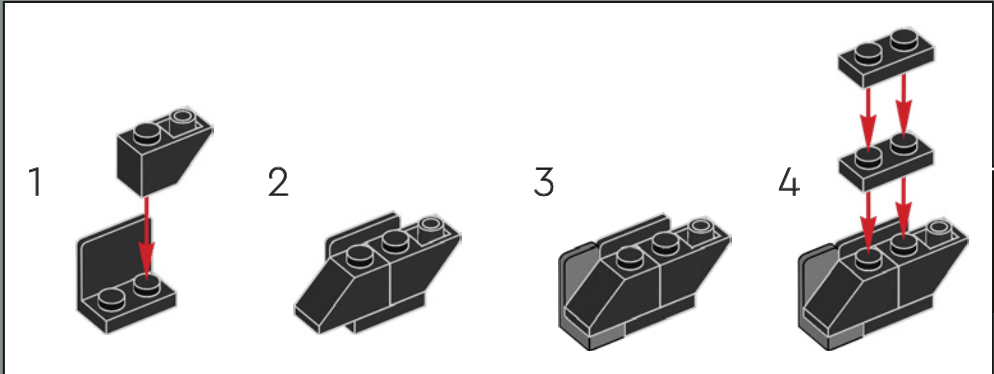



200

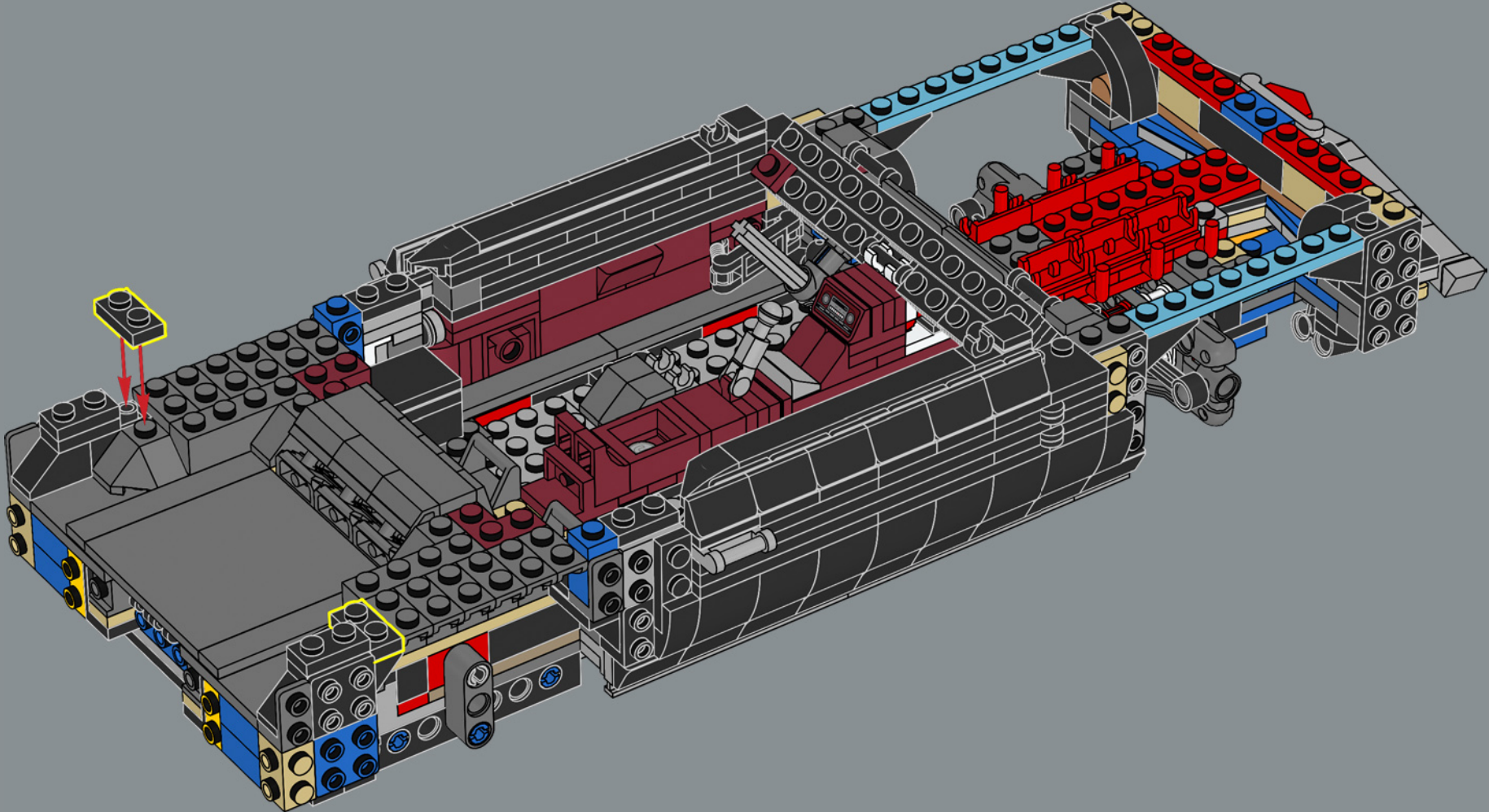



2x

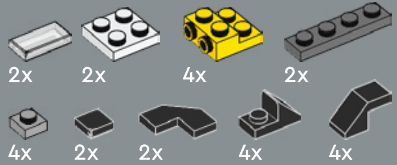

201

1

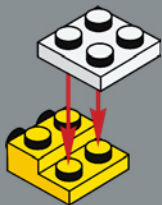

2

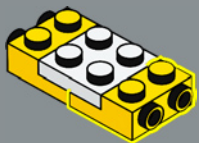

3

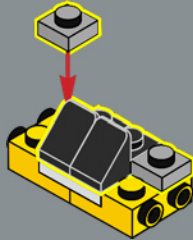

4

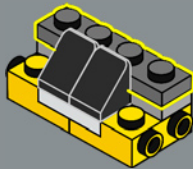

5

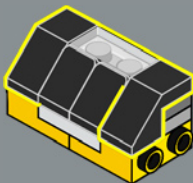

2x

6

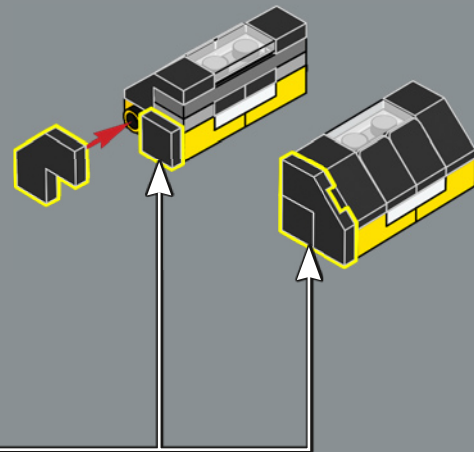

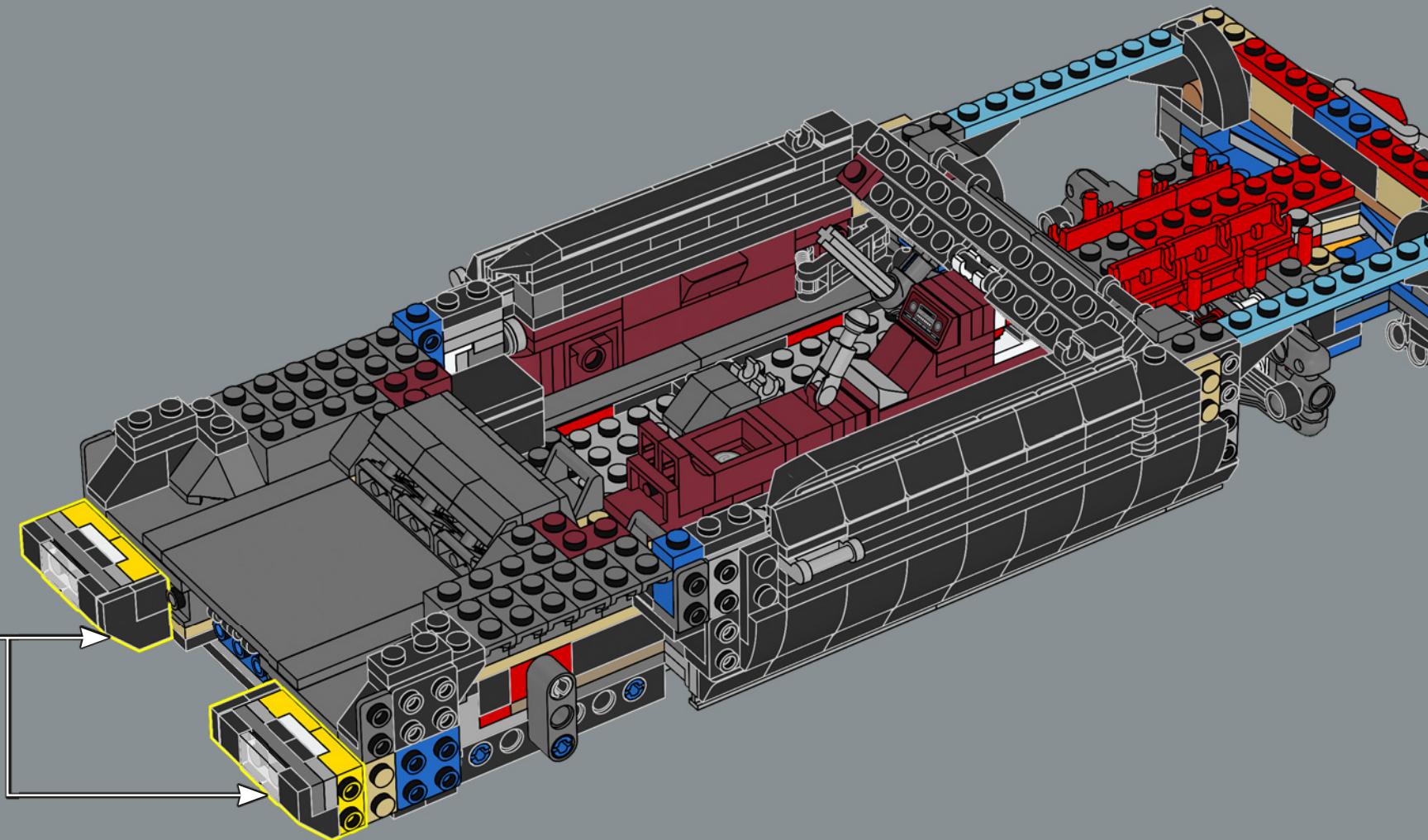



202

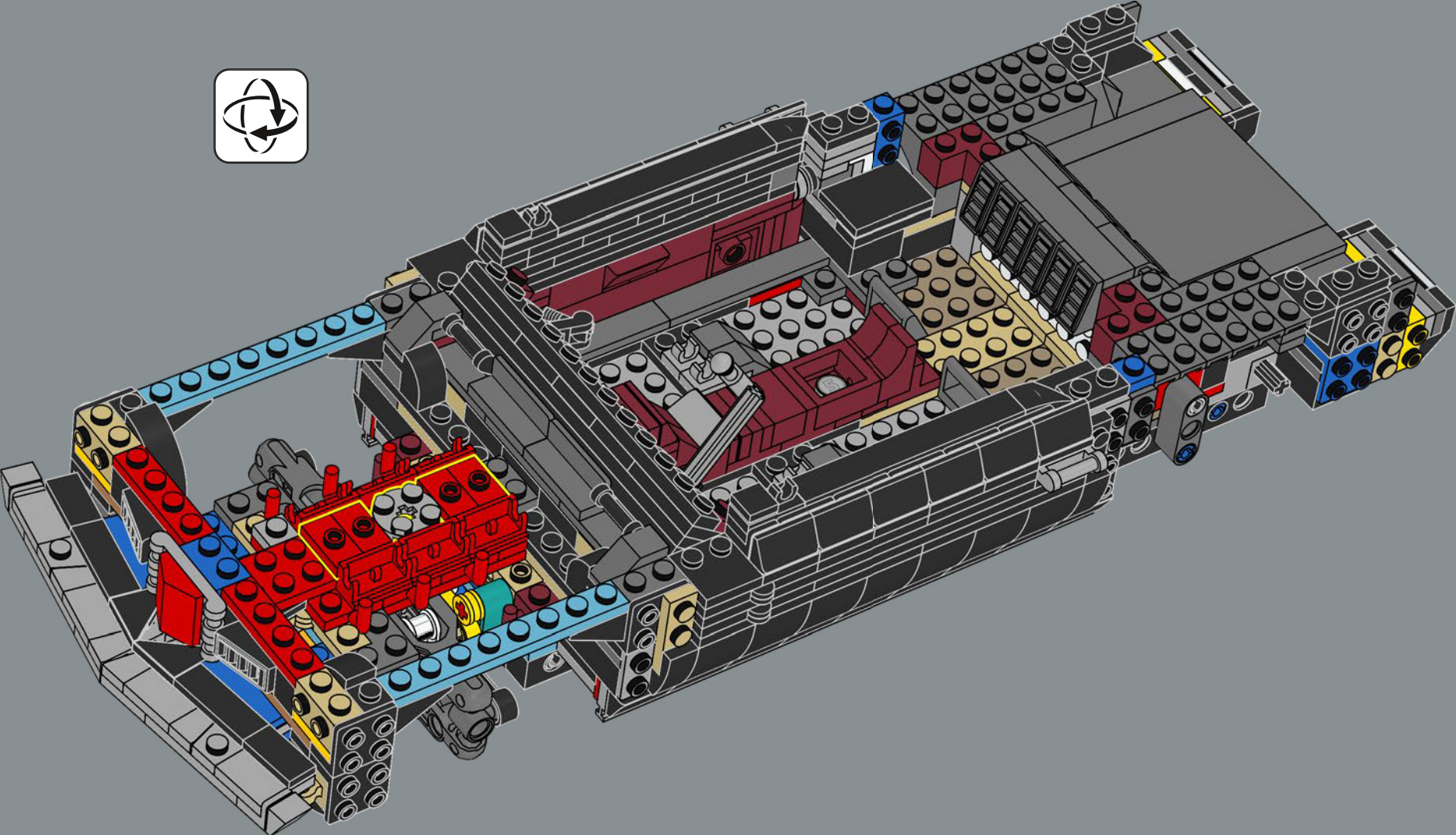

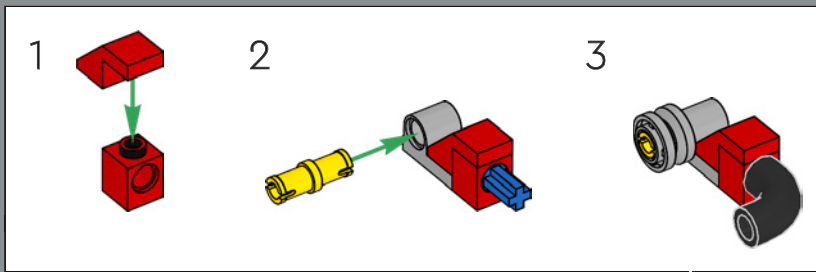
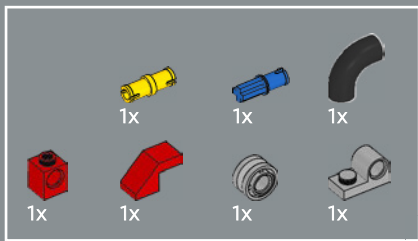

203

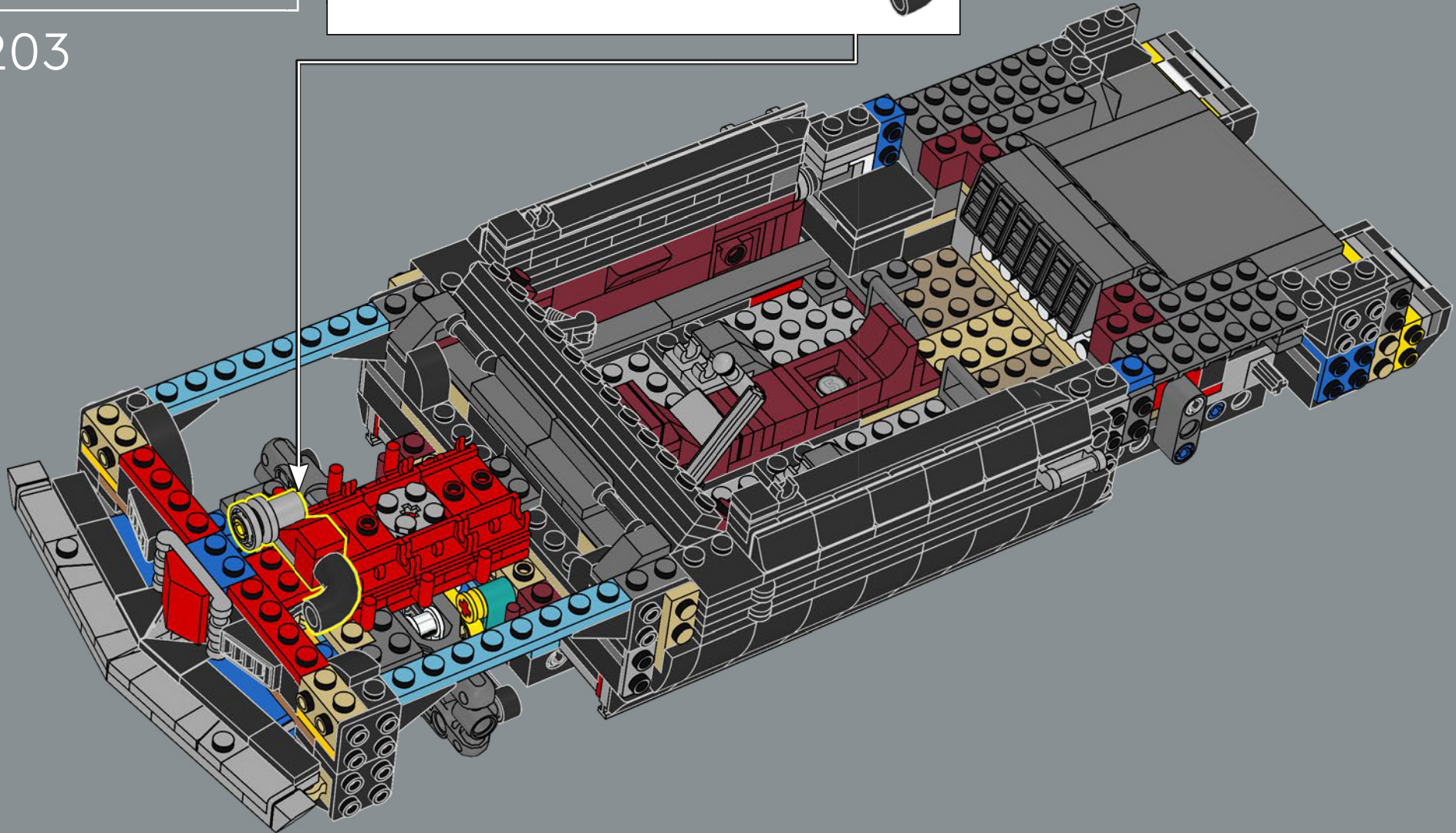

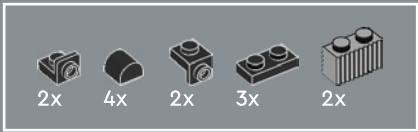

204

1

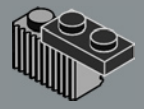

2

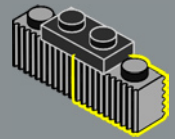

3

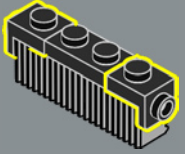

4

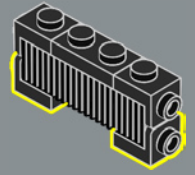

5

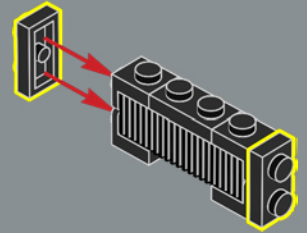

6

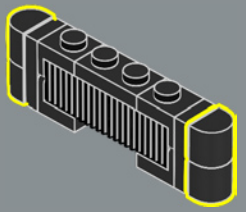

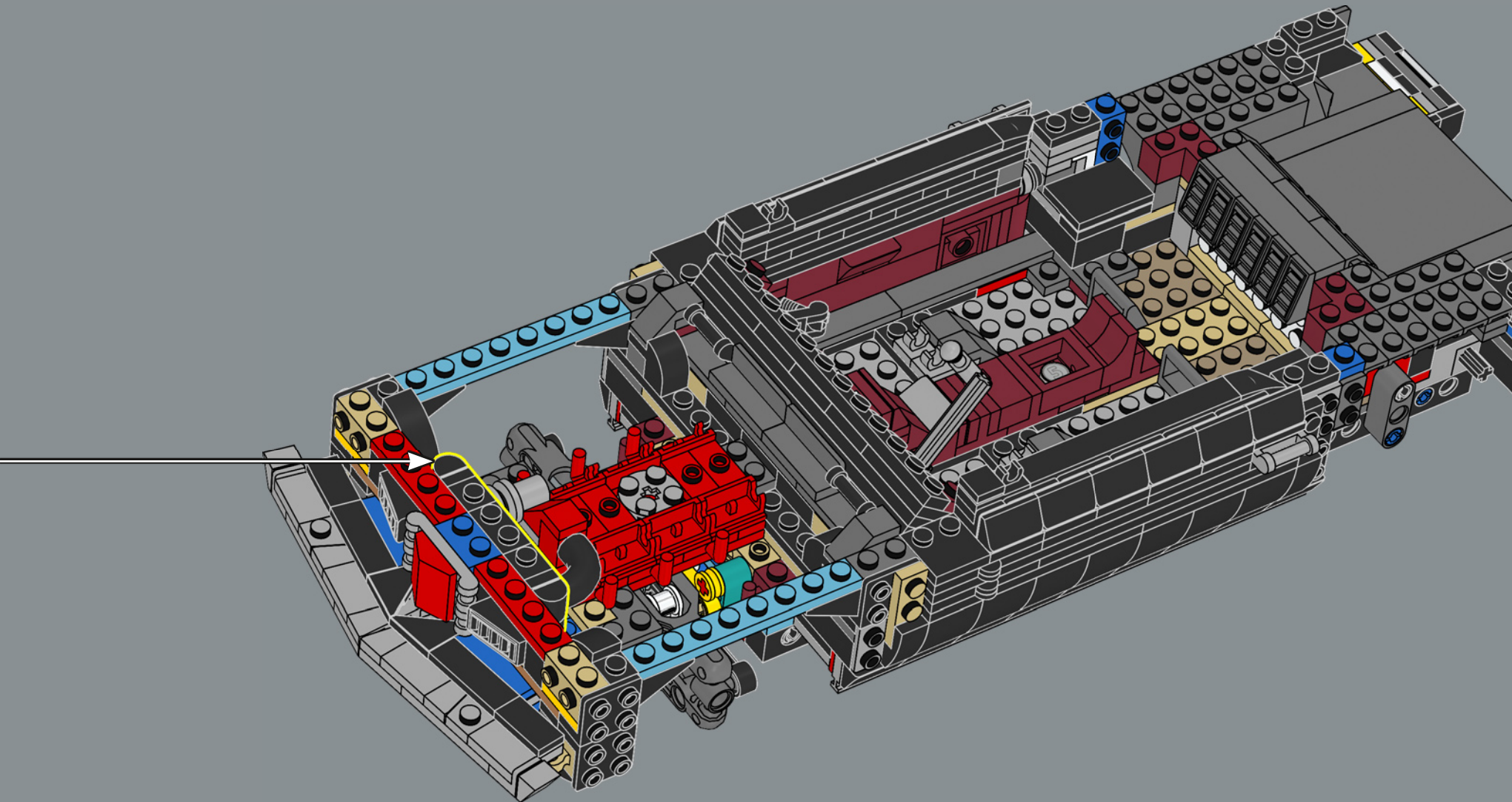

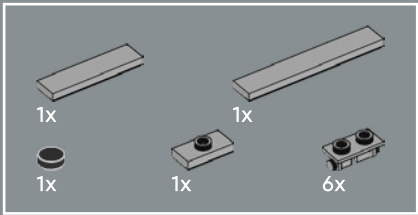

205

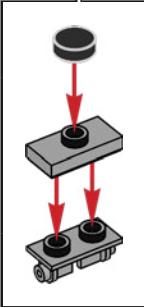
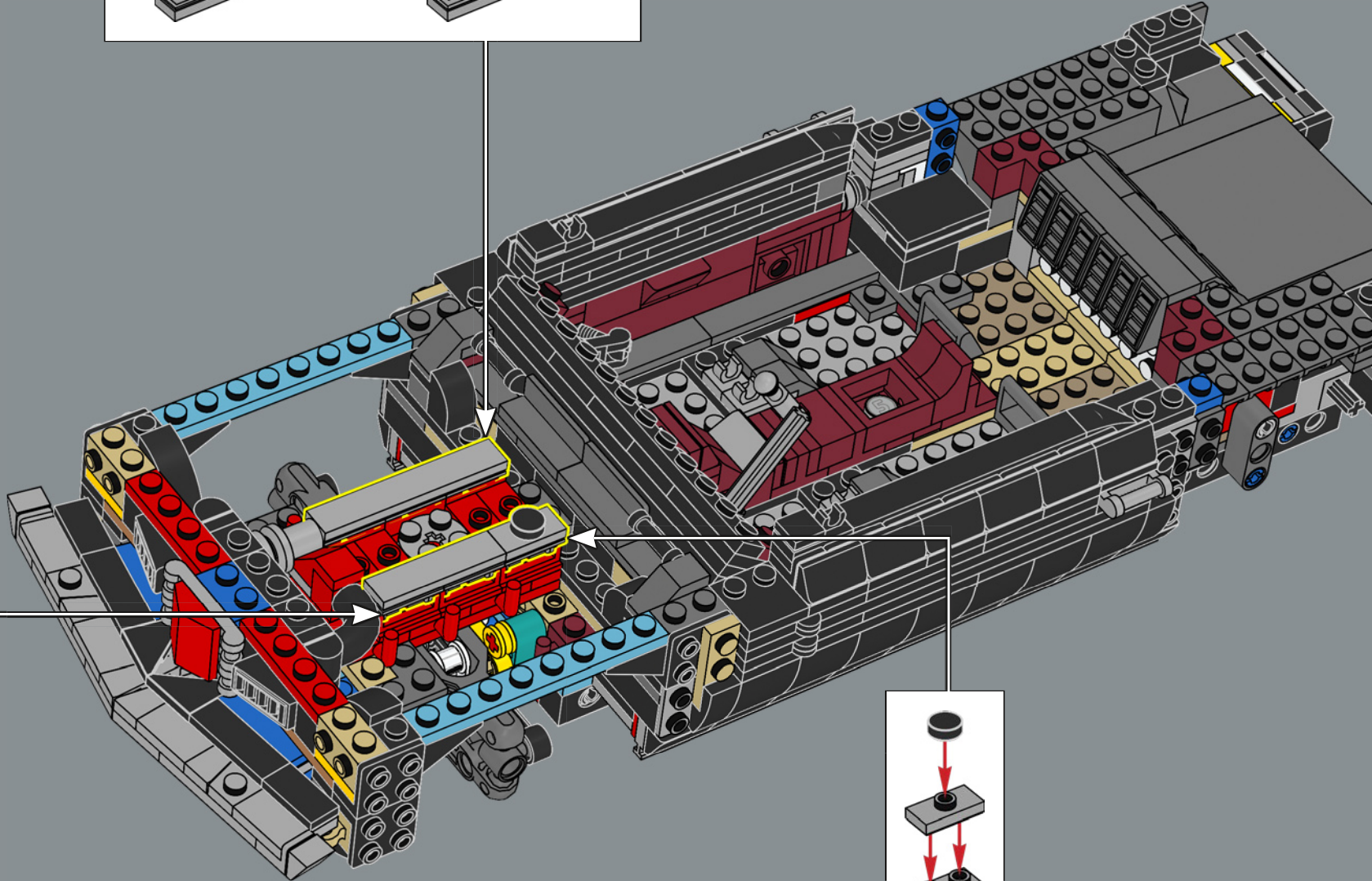
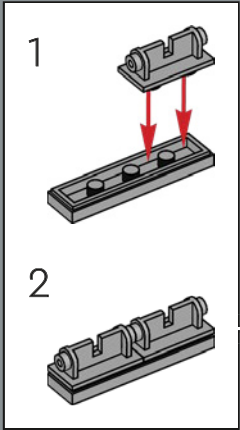
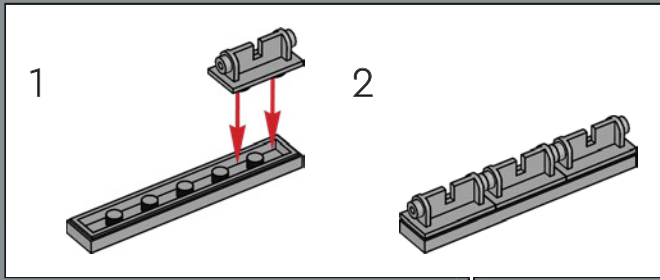



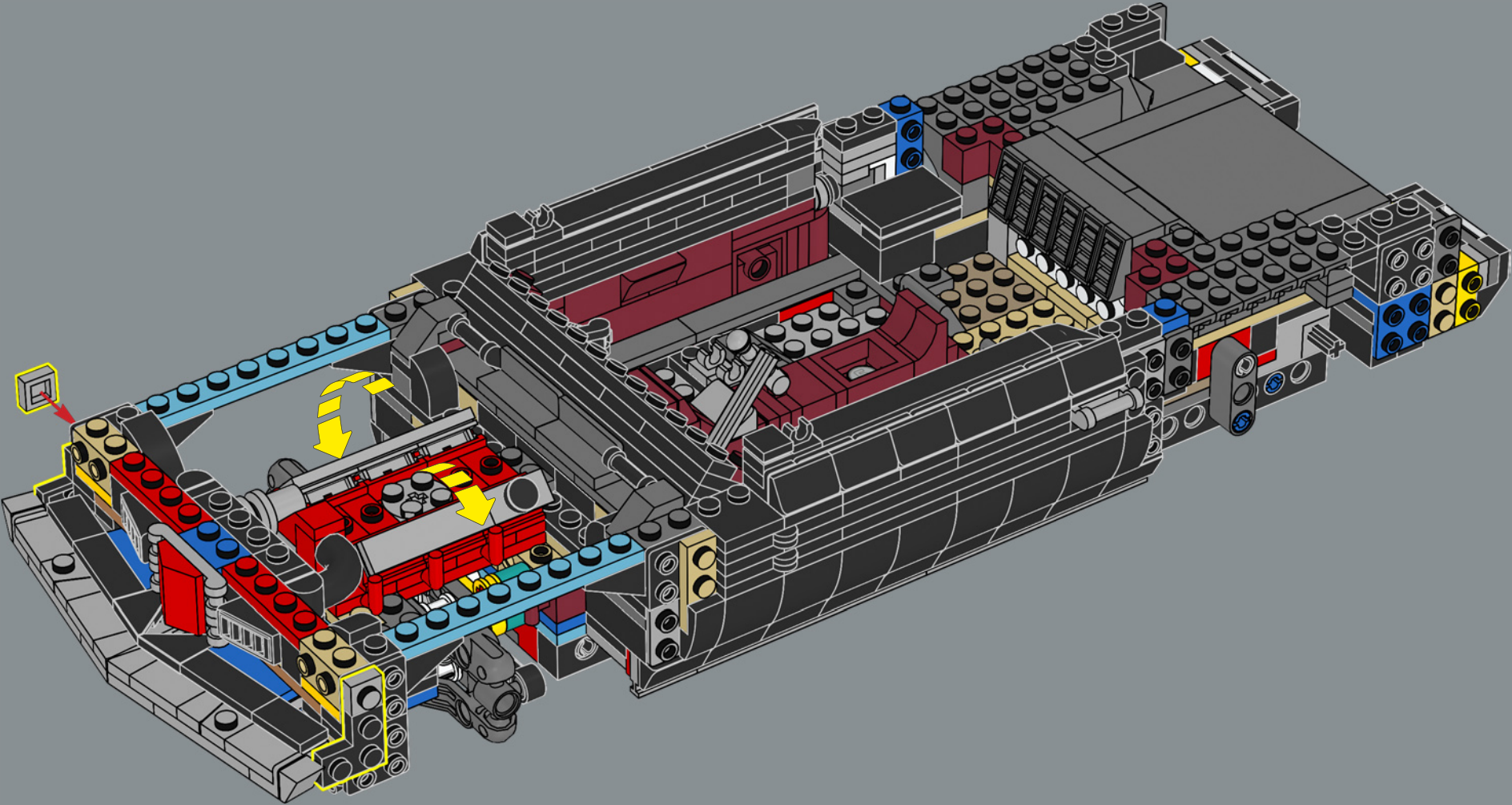

206



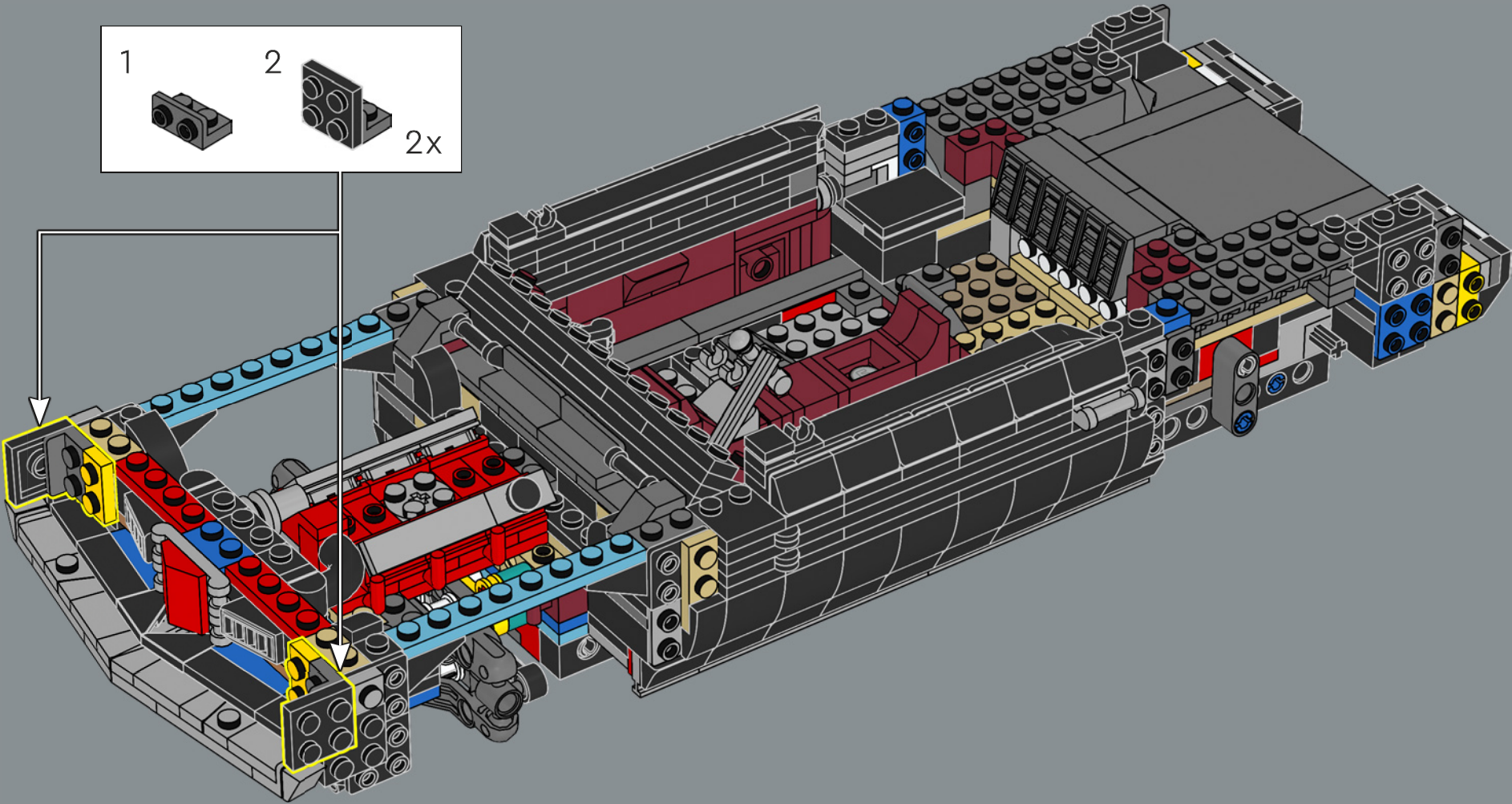
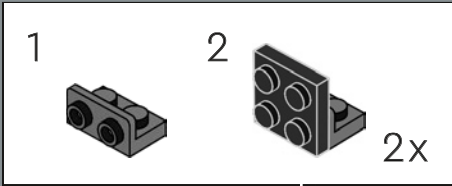

207



14x  2x 

208

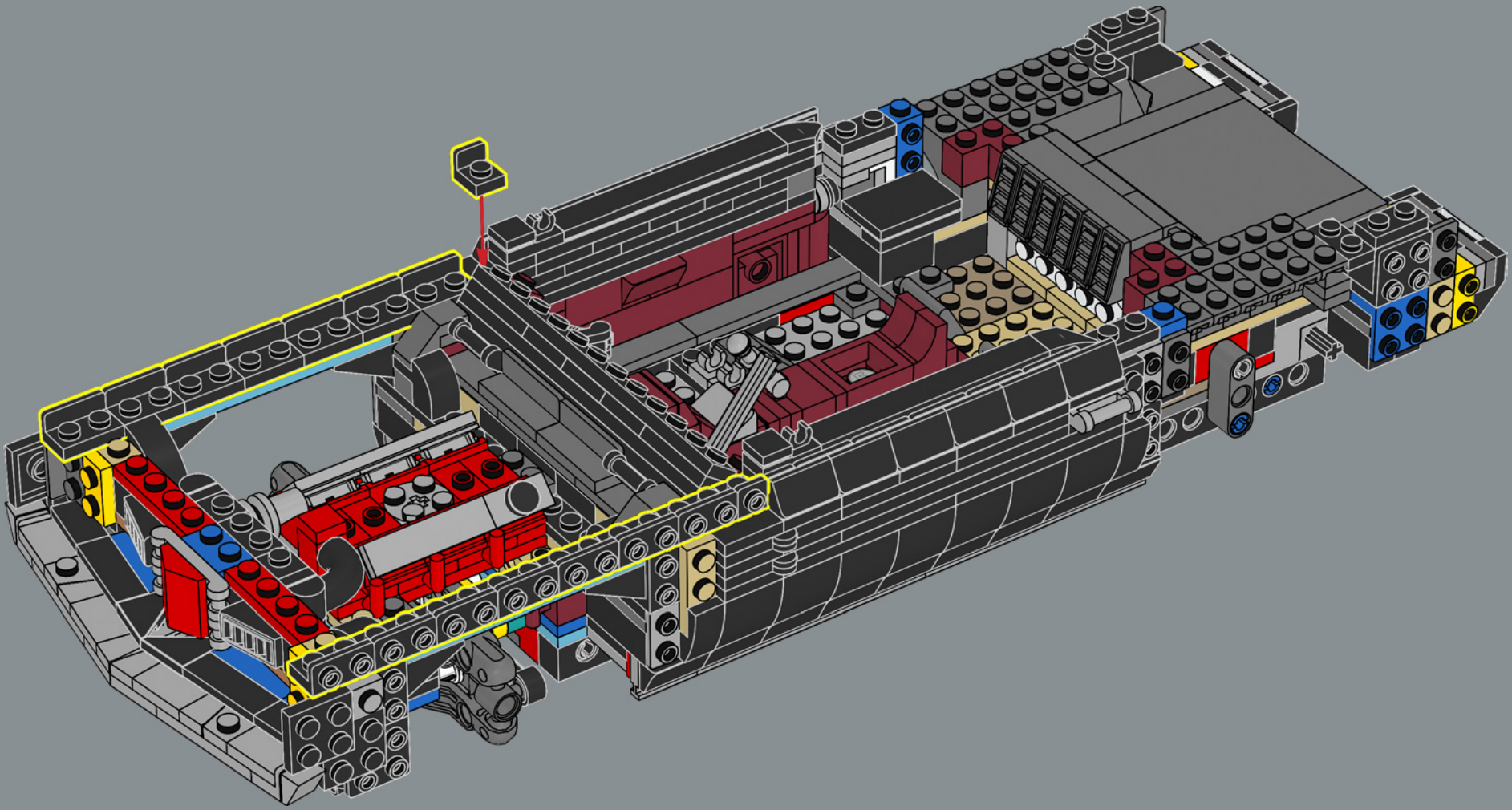

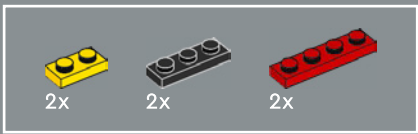

209

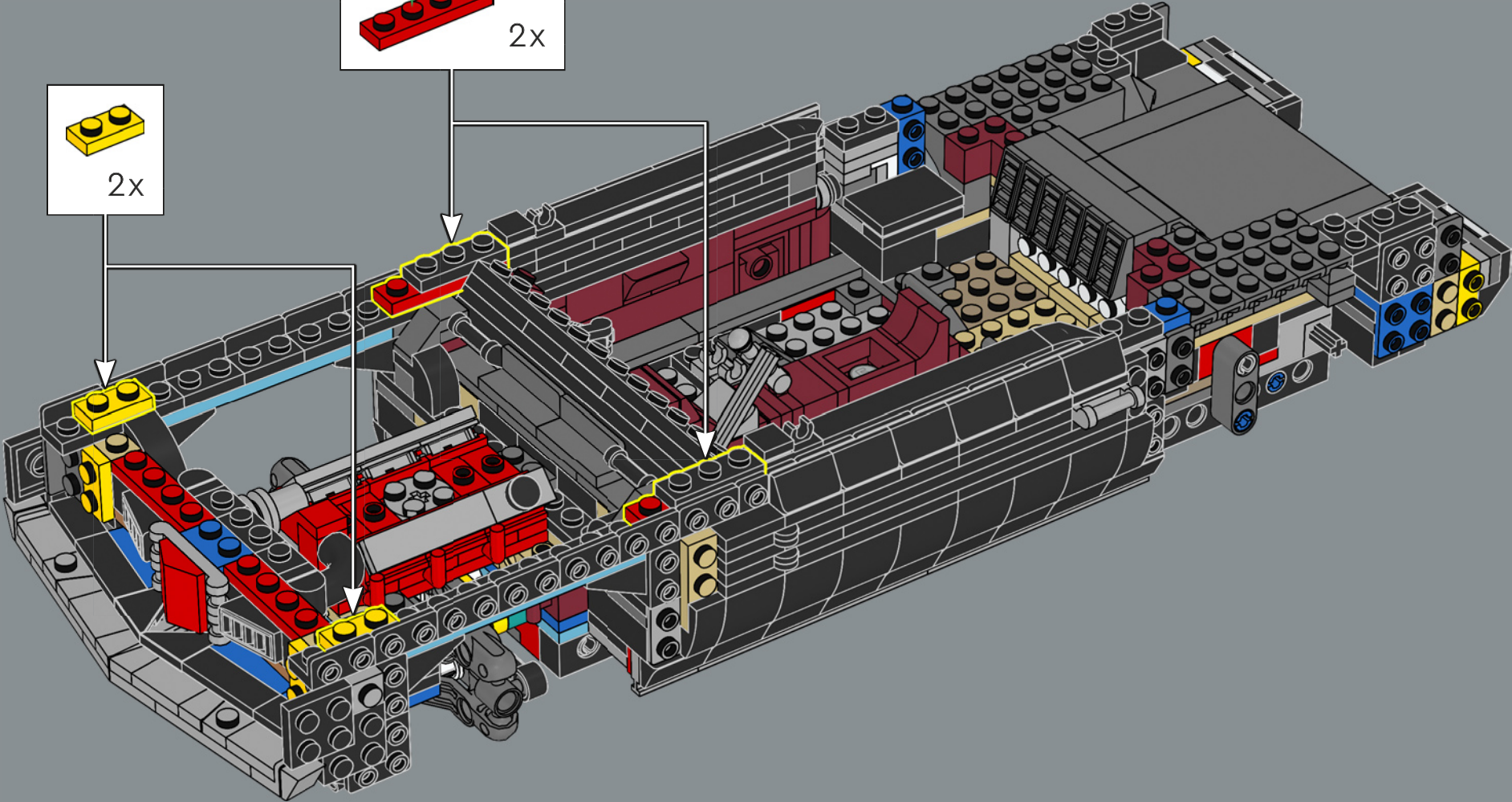
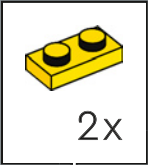
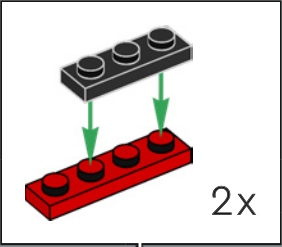



210

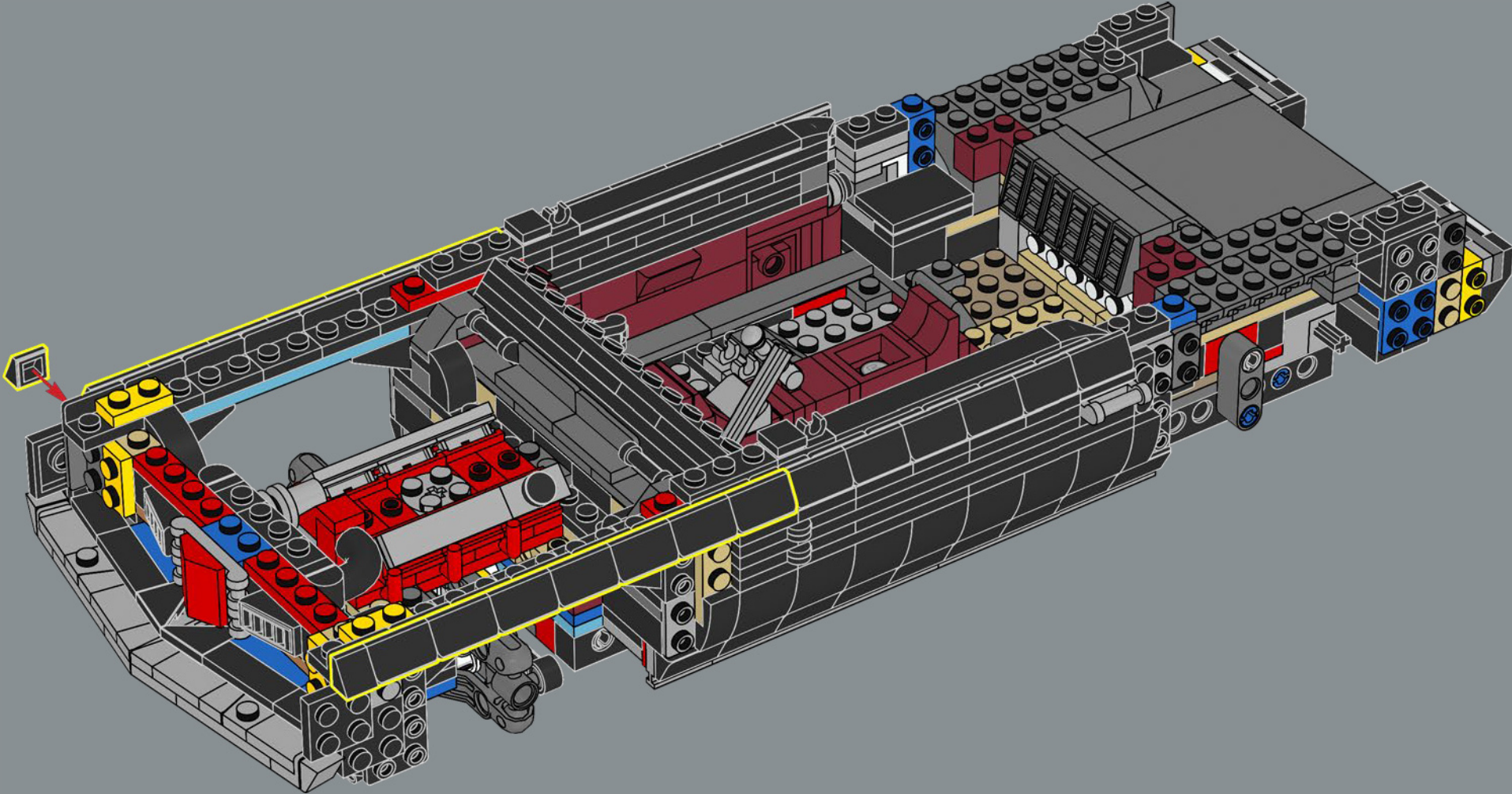

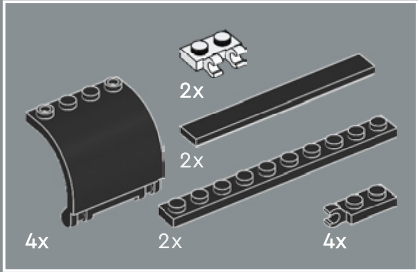
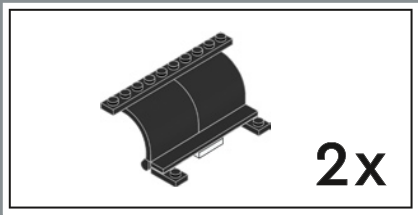

211

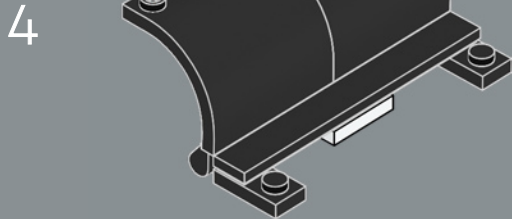
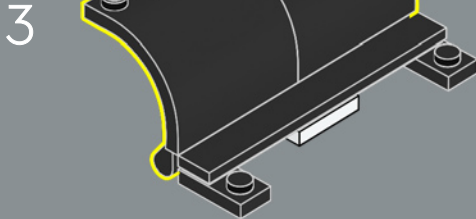
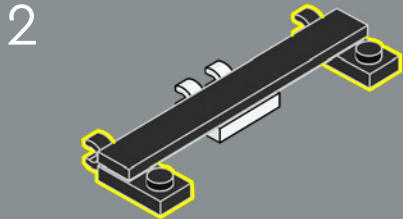
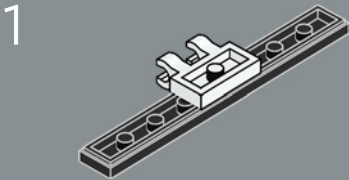

2x

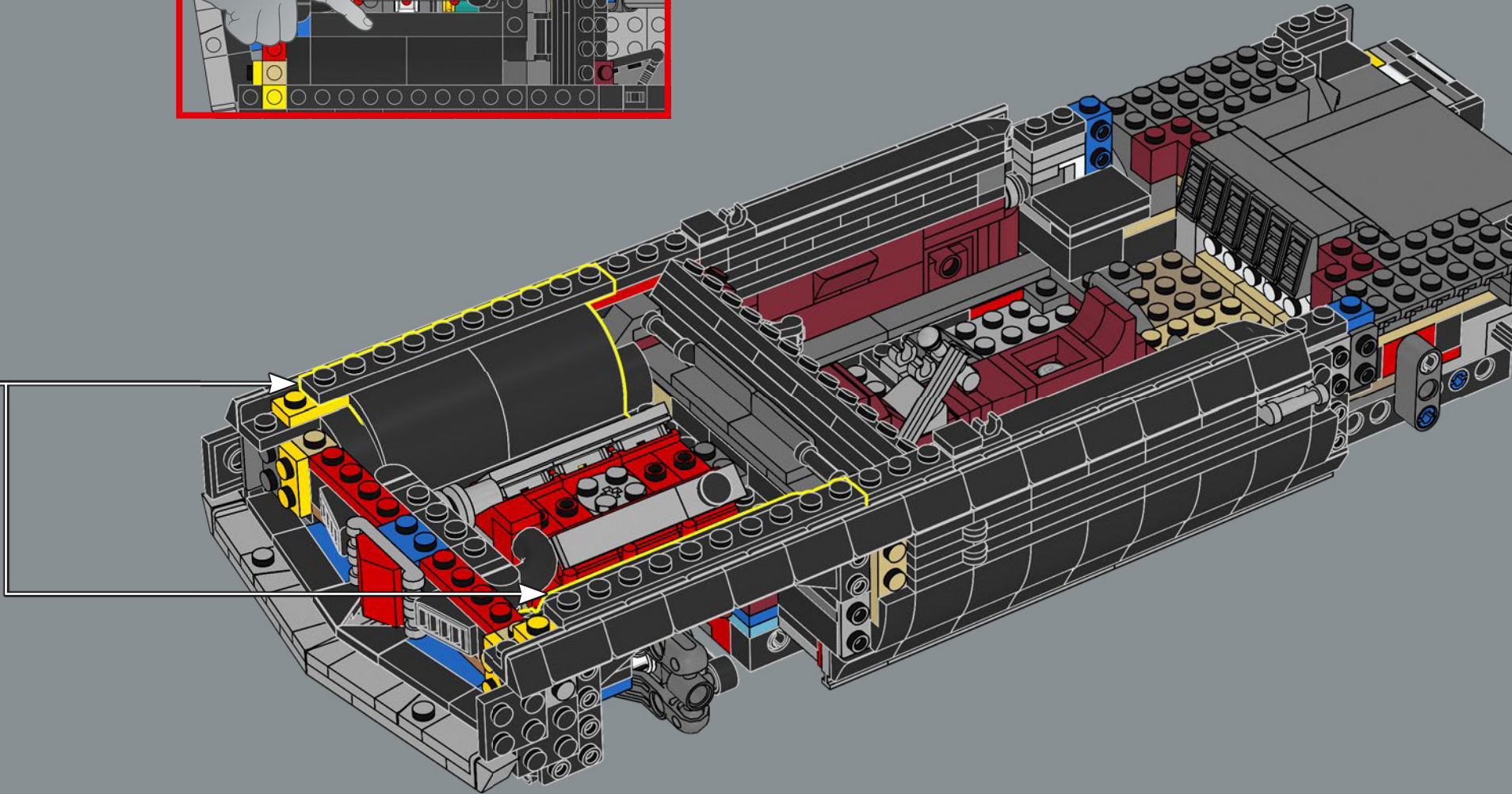
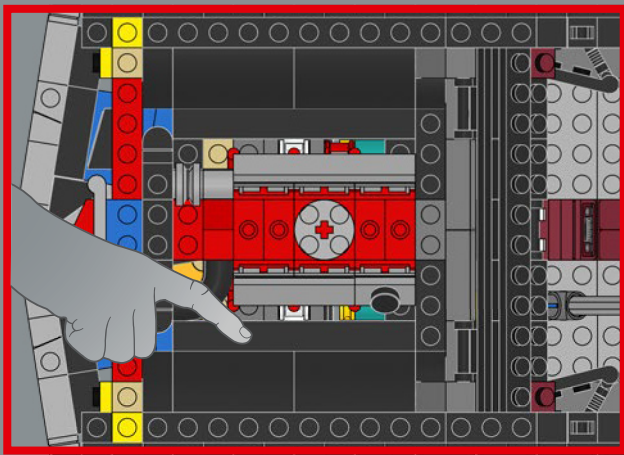

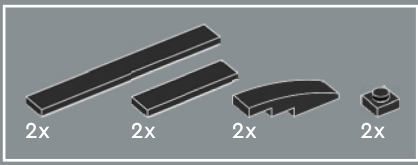

212

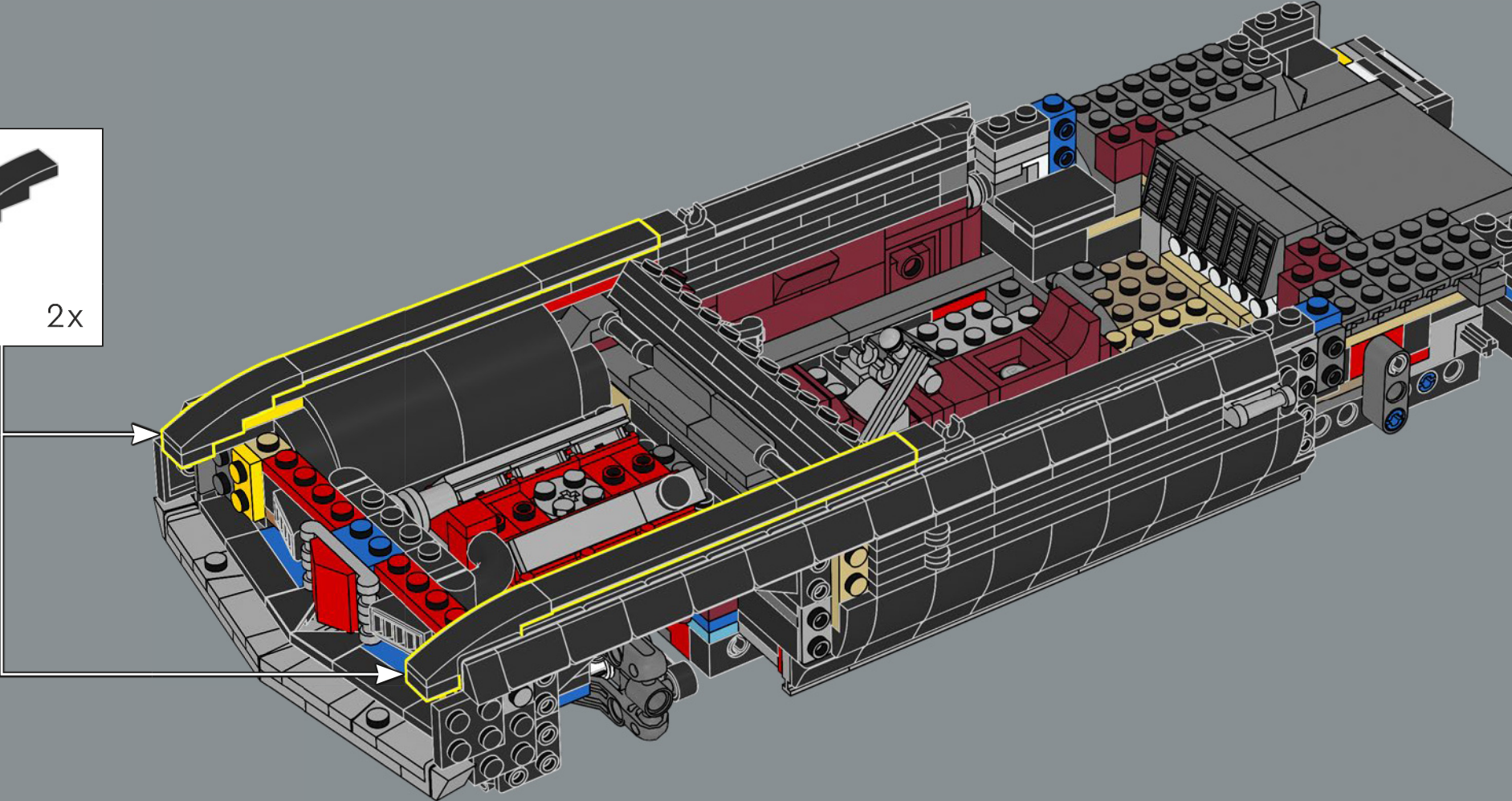
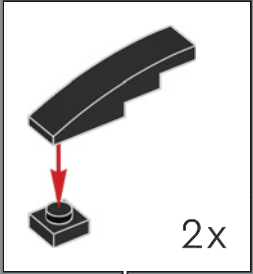

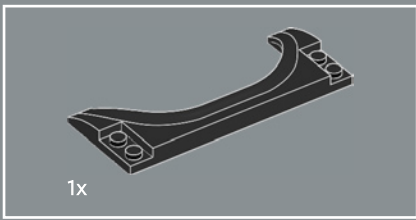

213

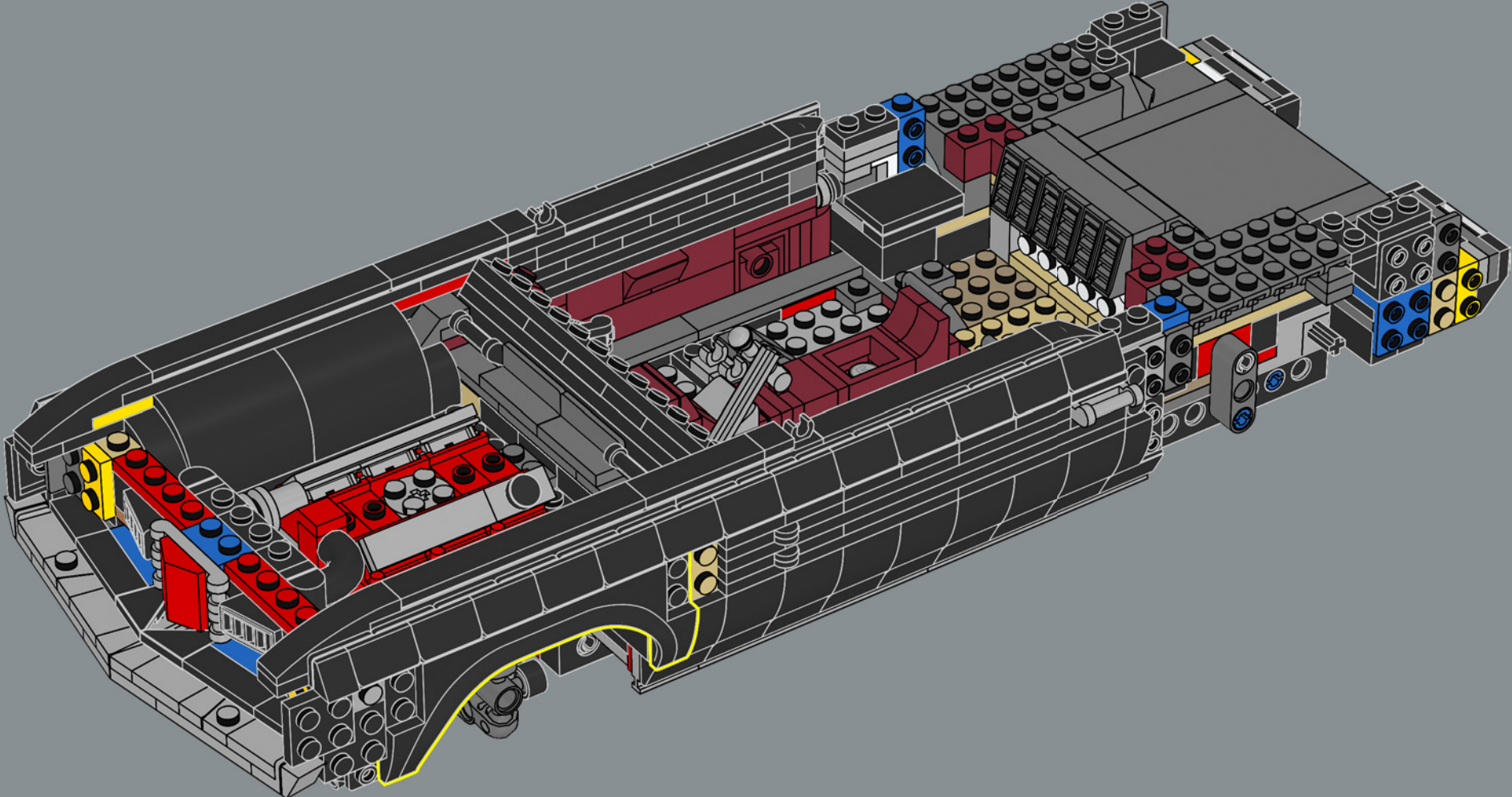

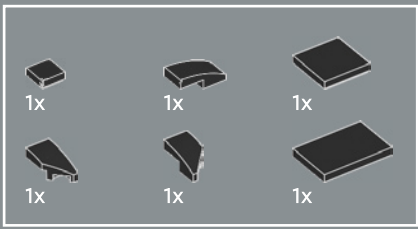

214

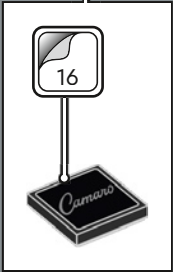
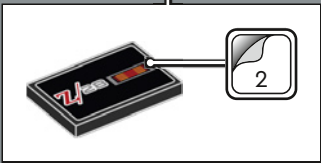
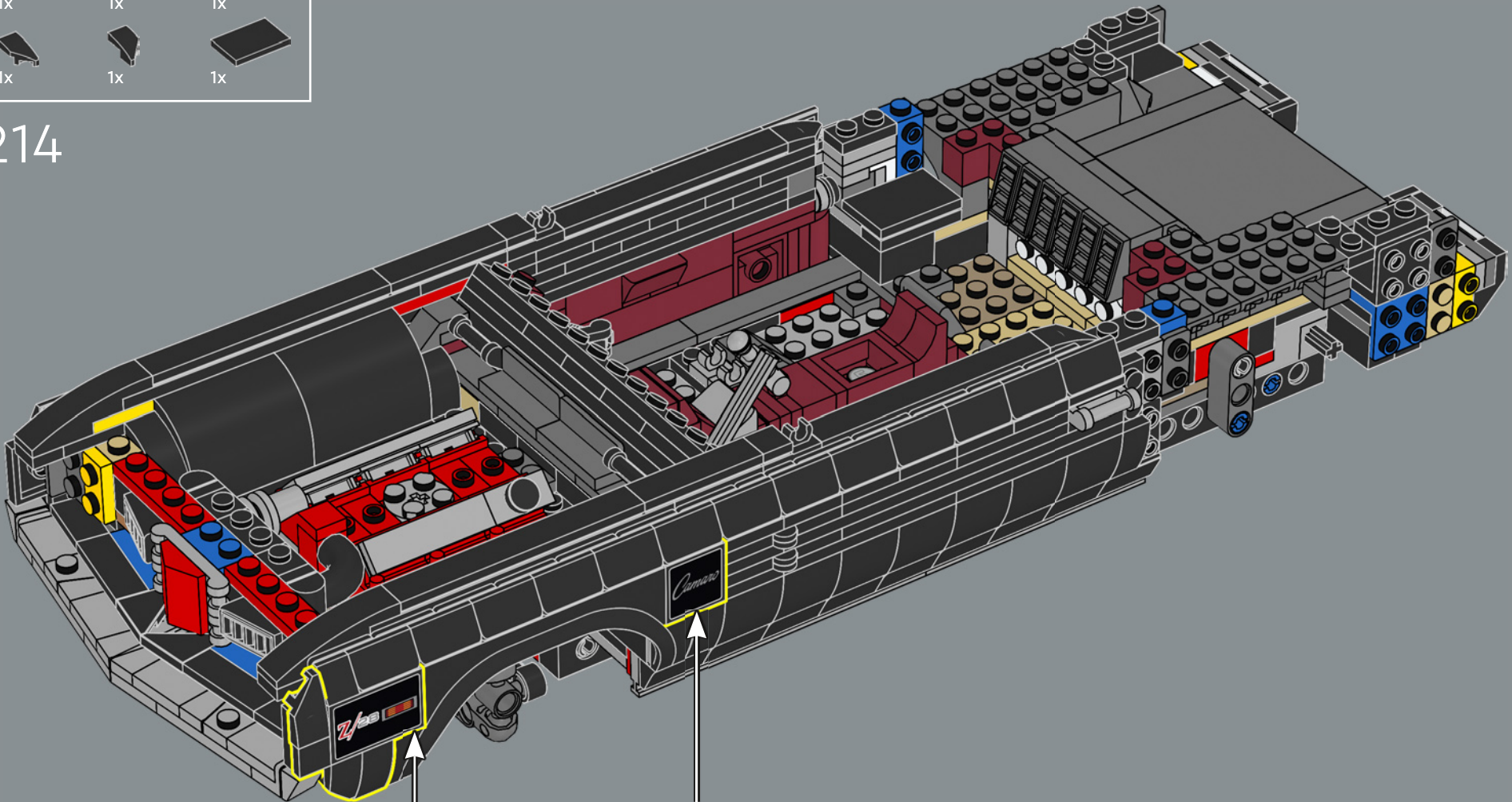

À l'origine, Chevrolet envisageait également de produire une version break de la Camaro.

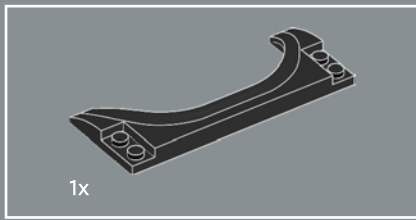

215

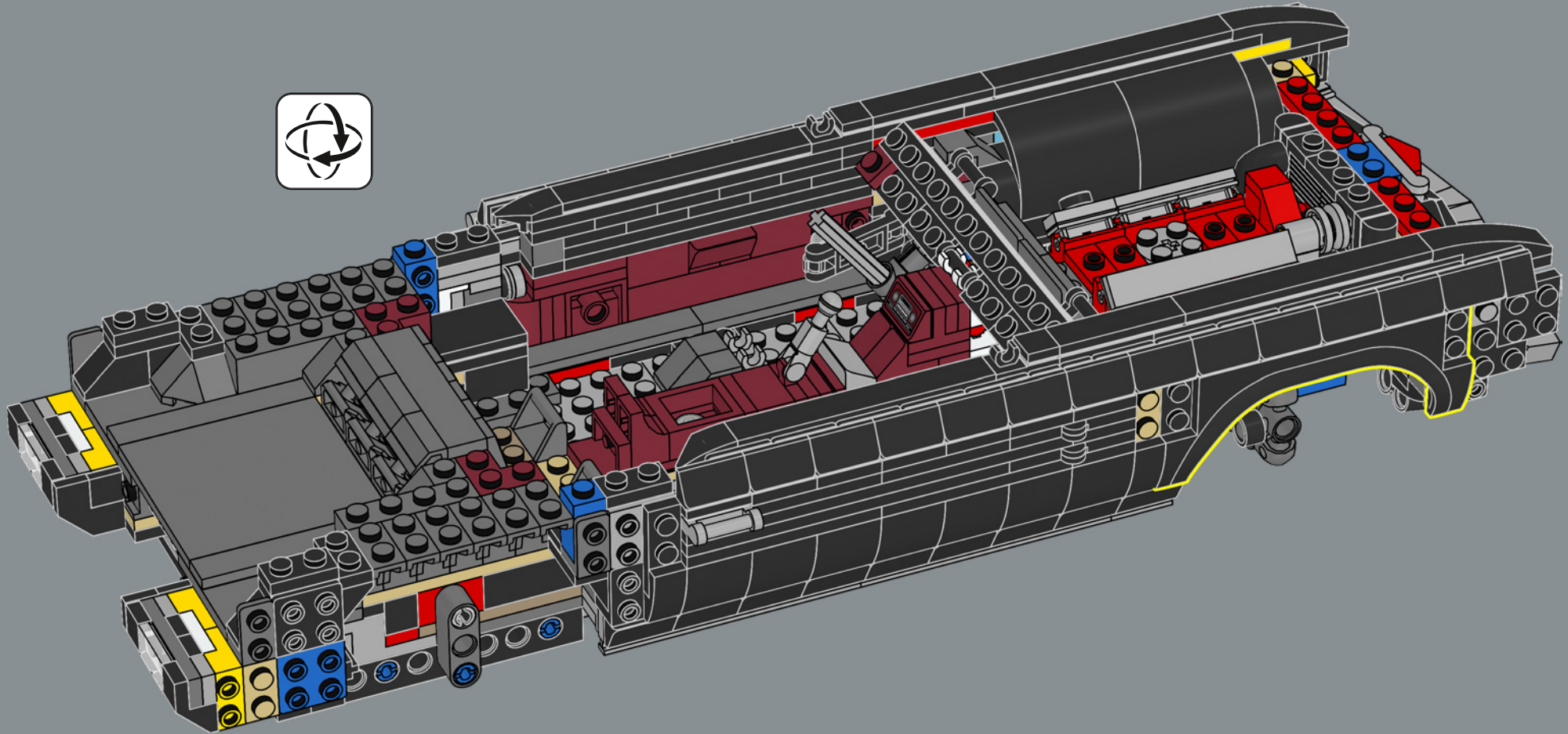

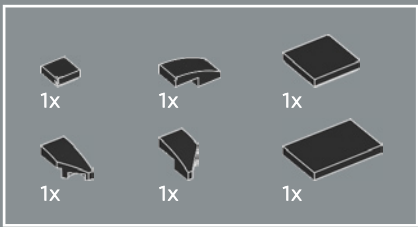

216

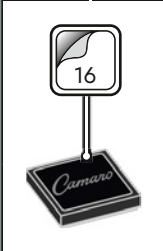
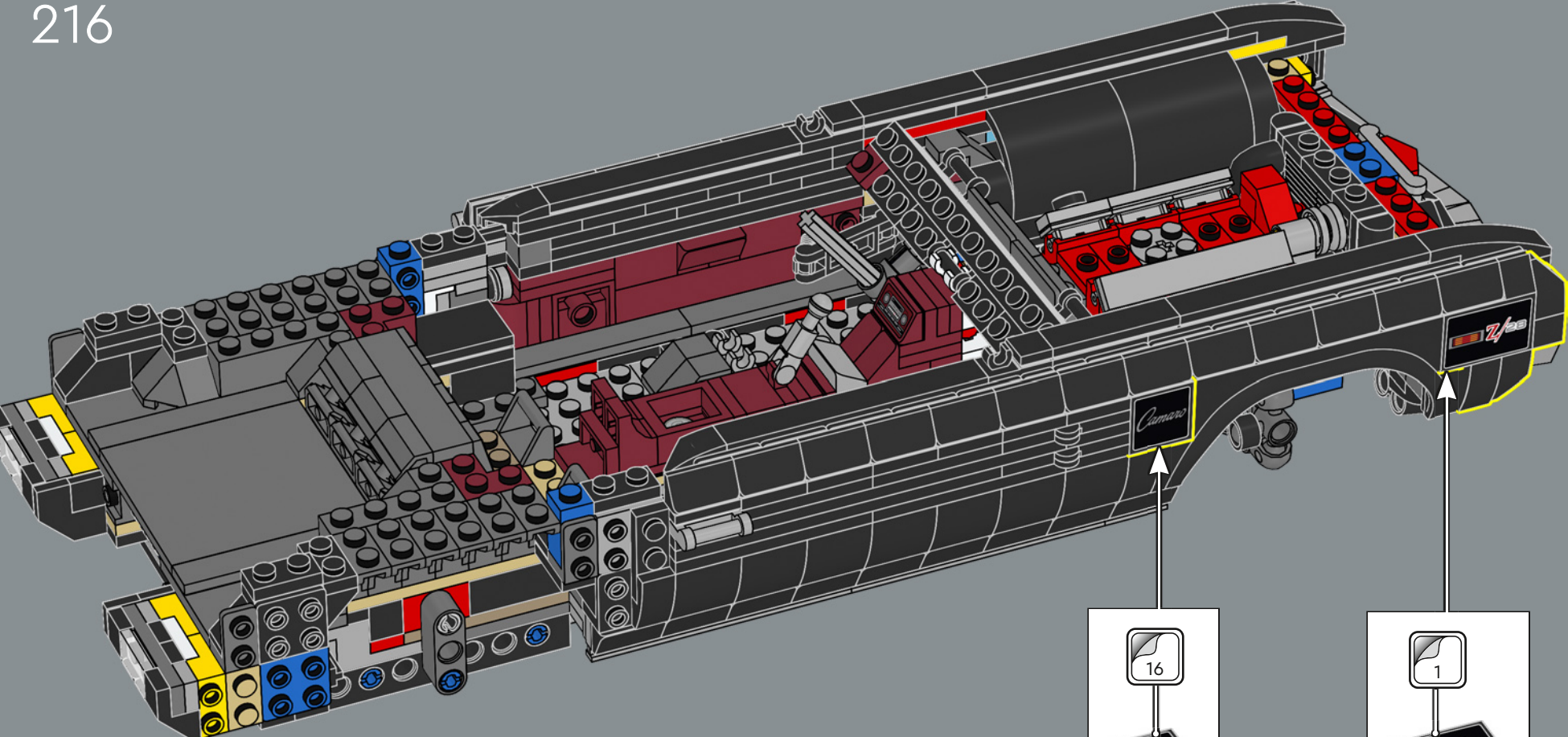

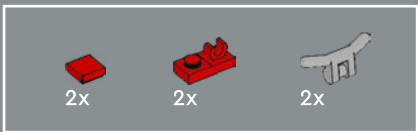

217

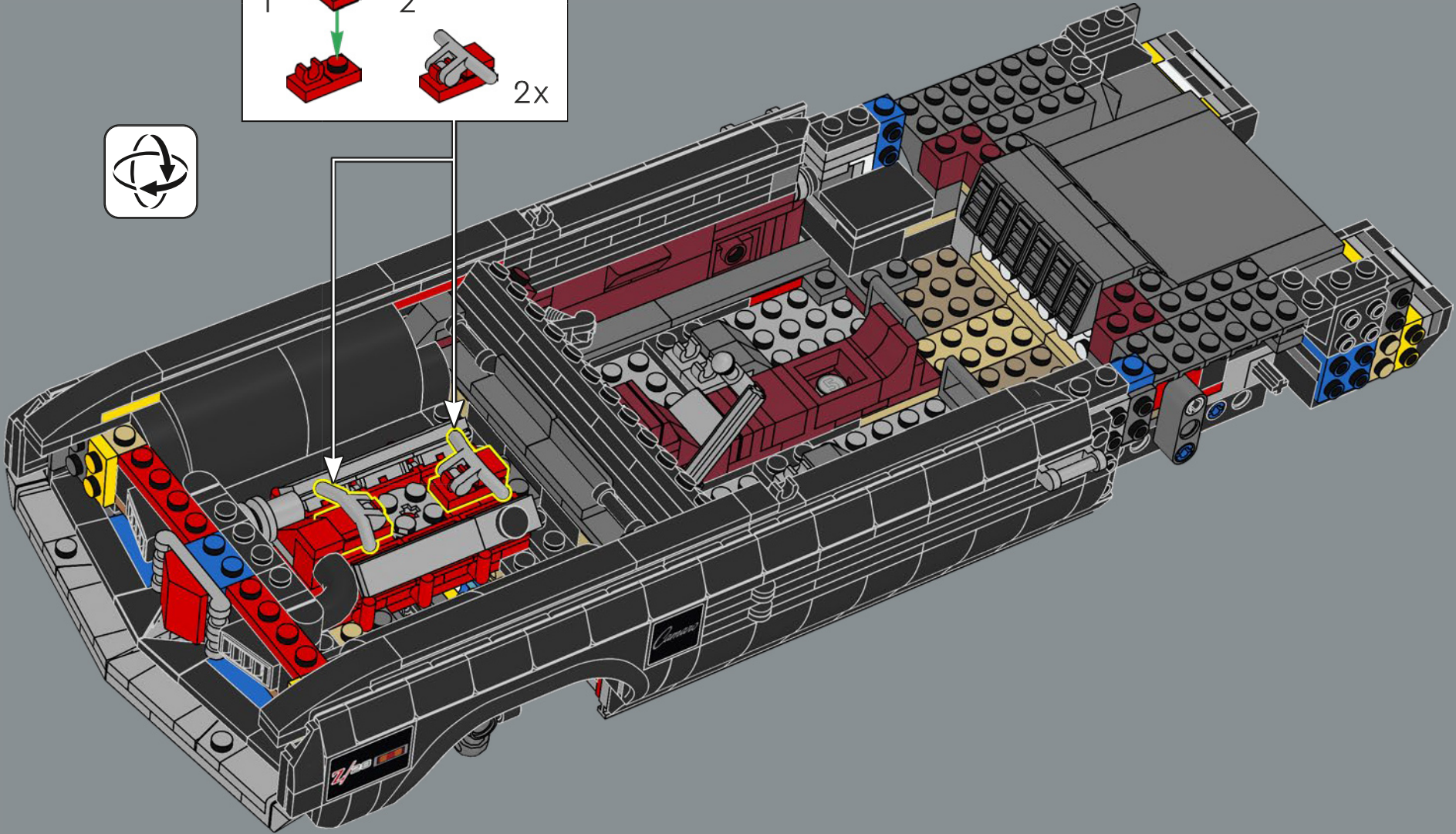
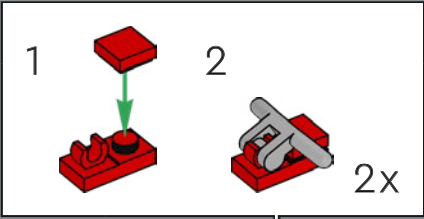

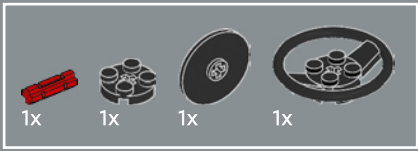

218

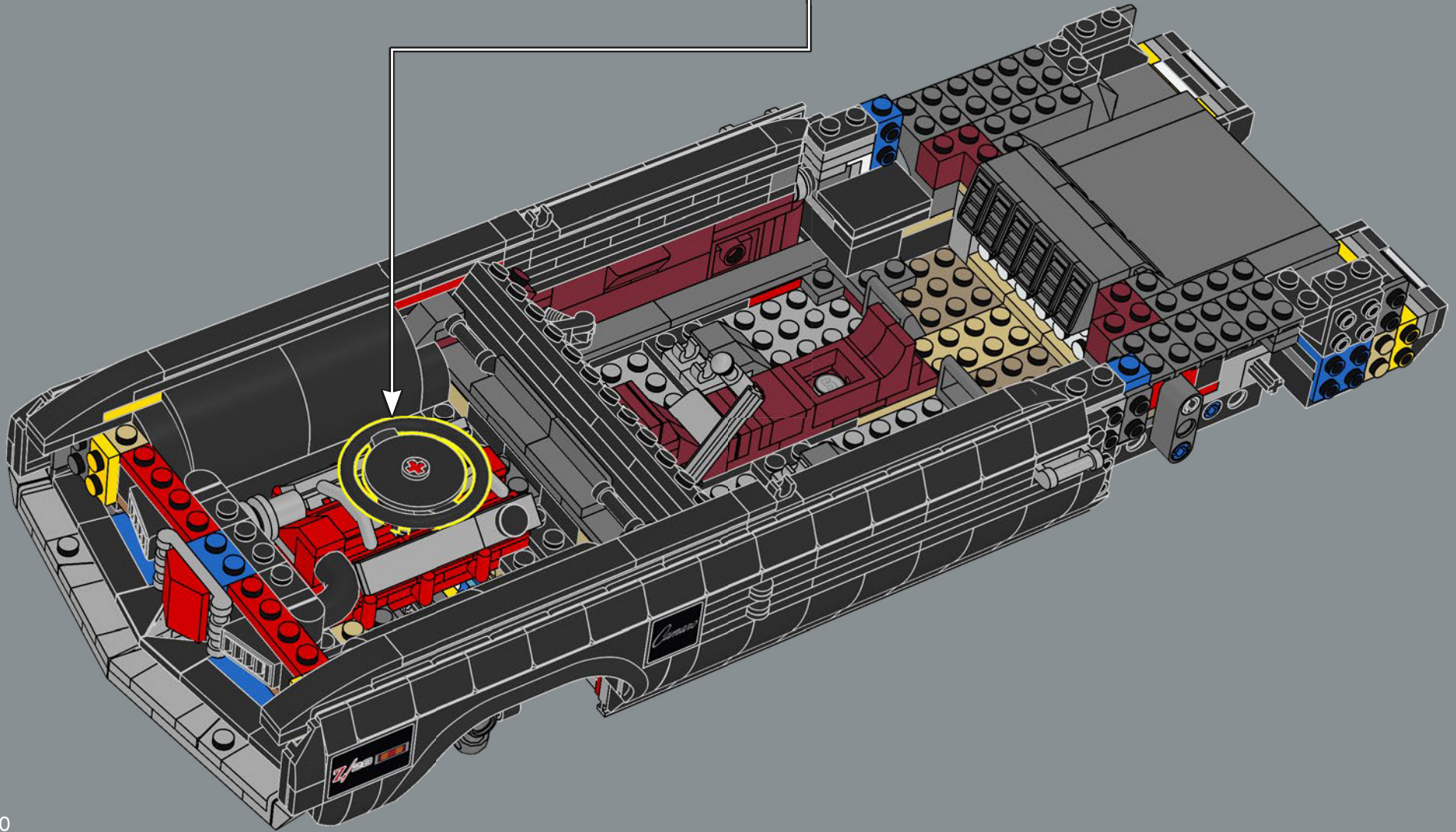
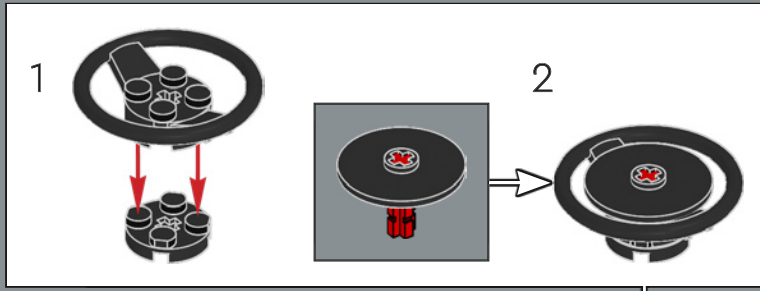

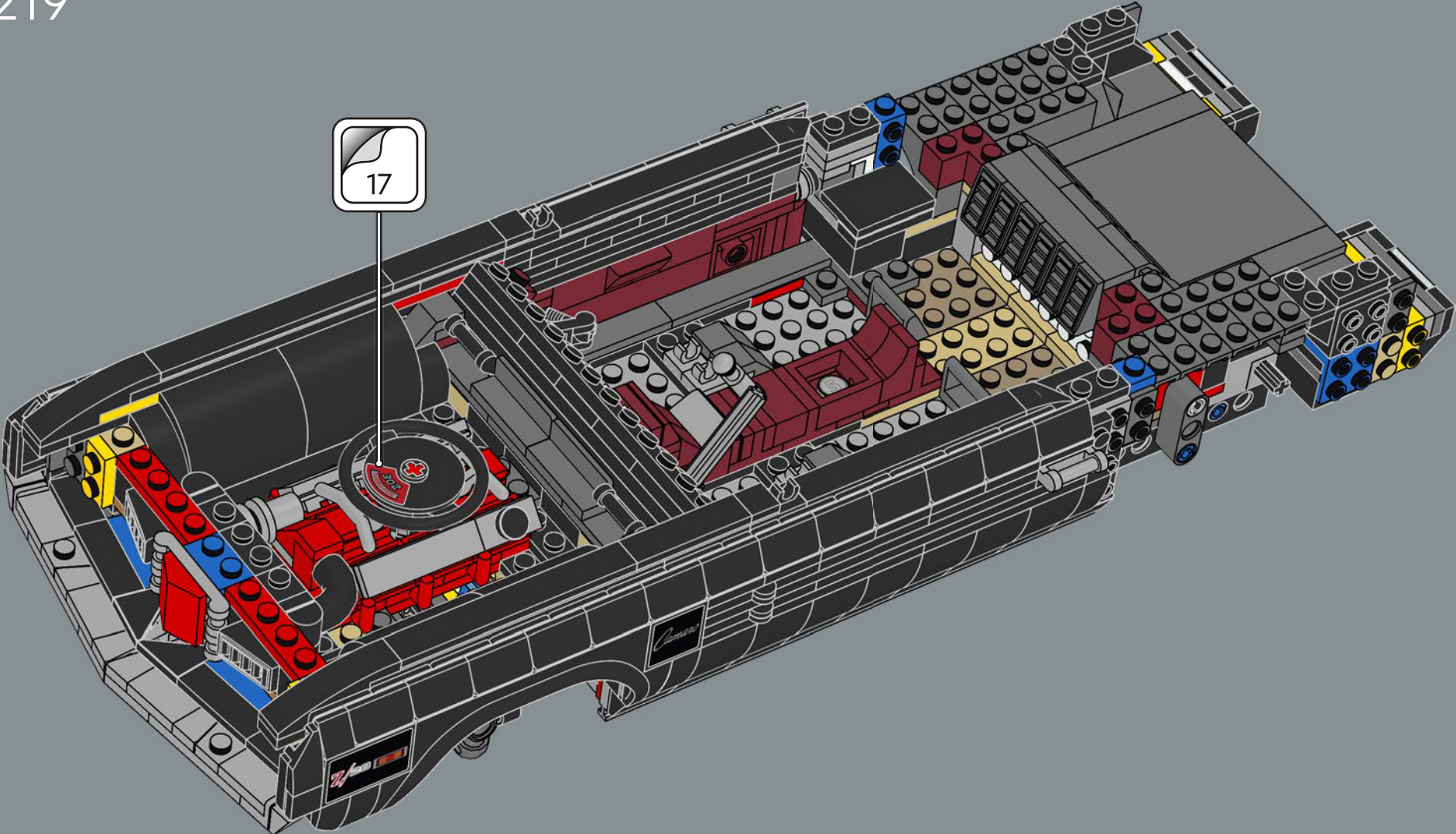

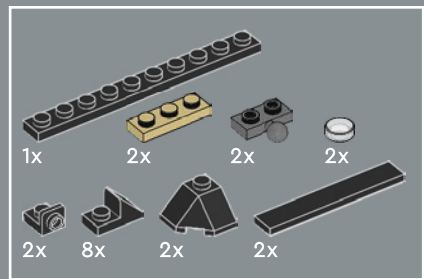

220

1

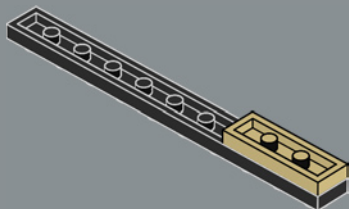

2

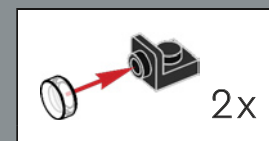
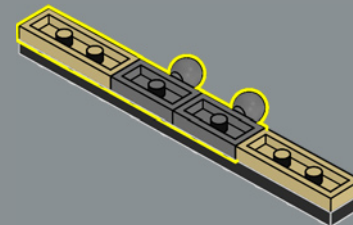

3

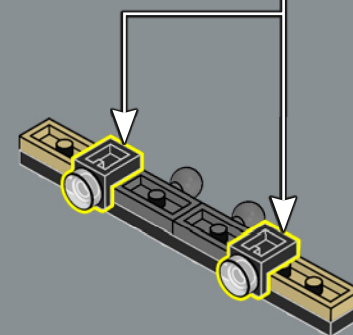

4

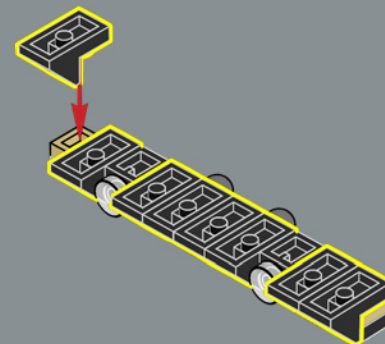

5

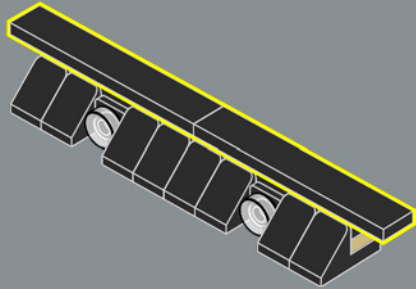

6

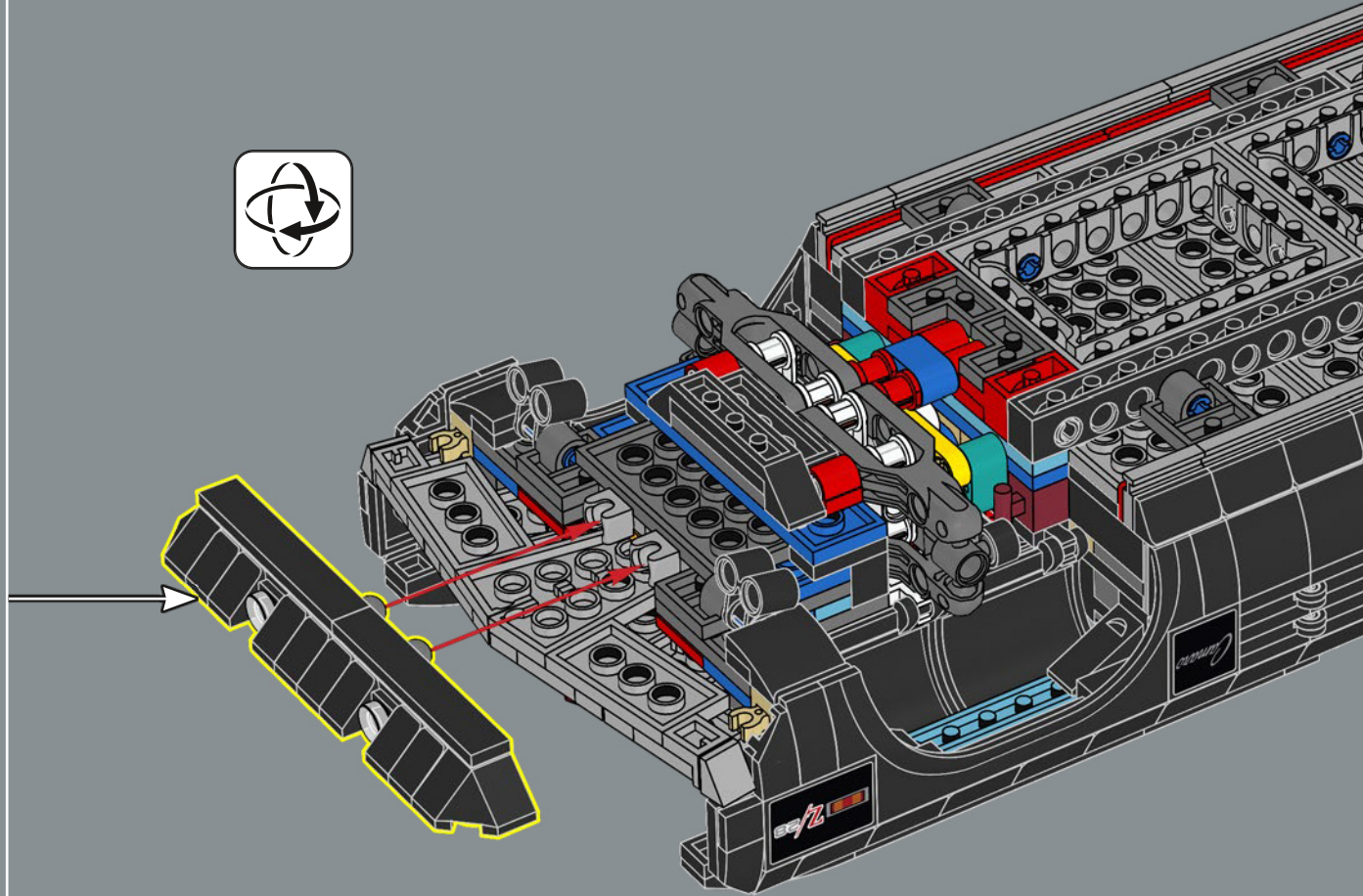
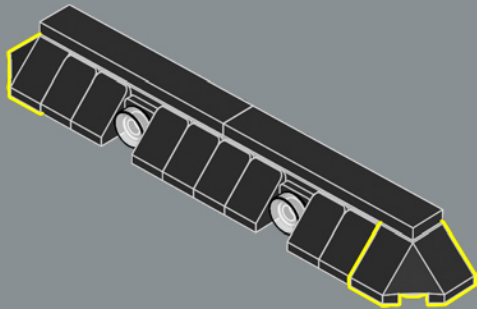

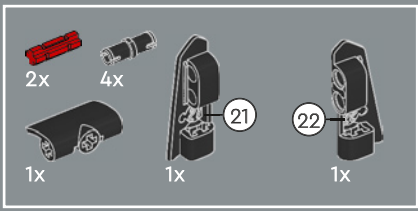

221

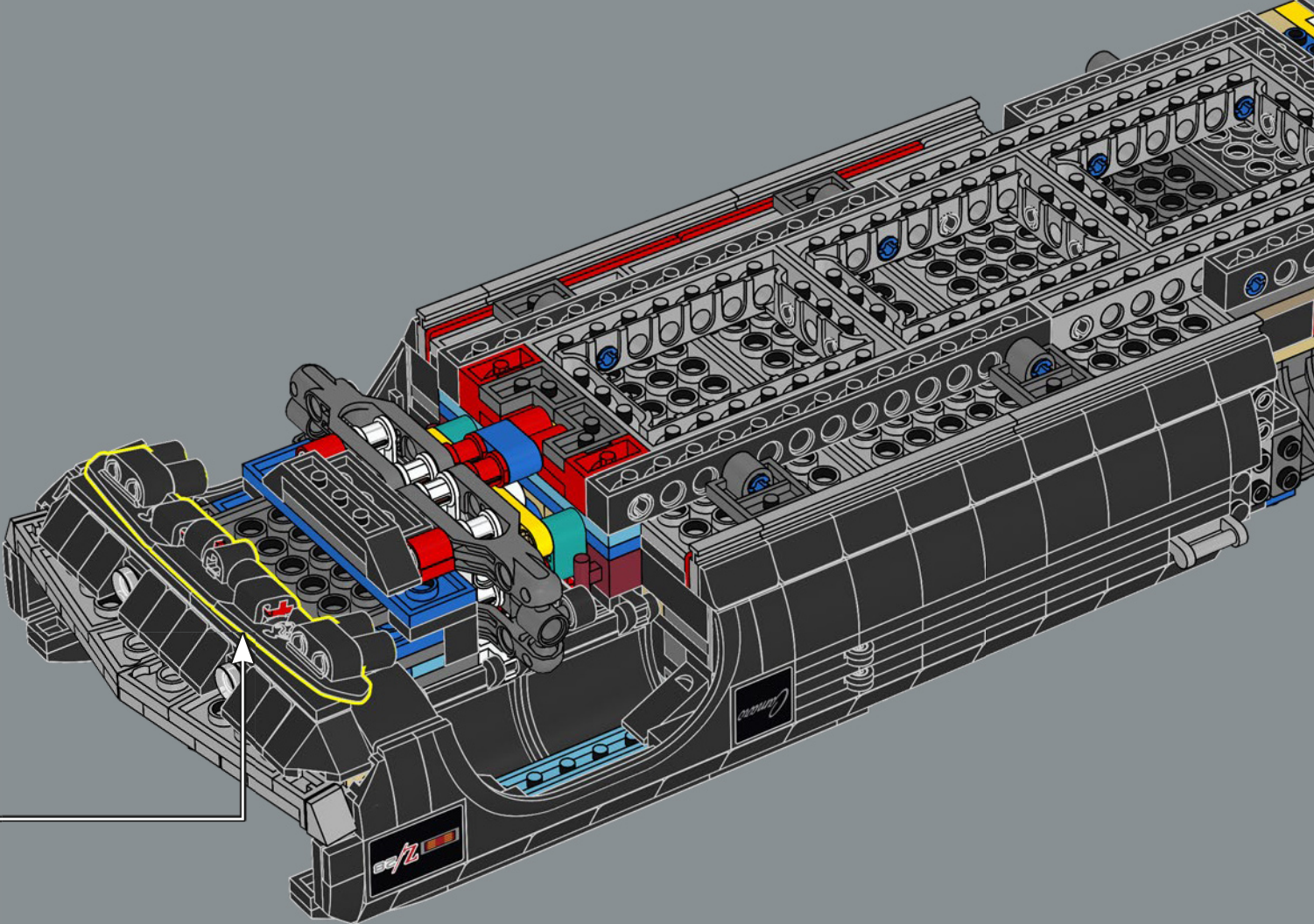
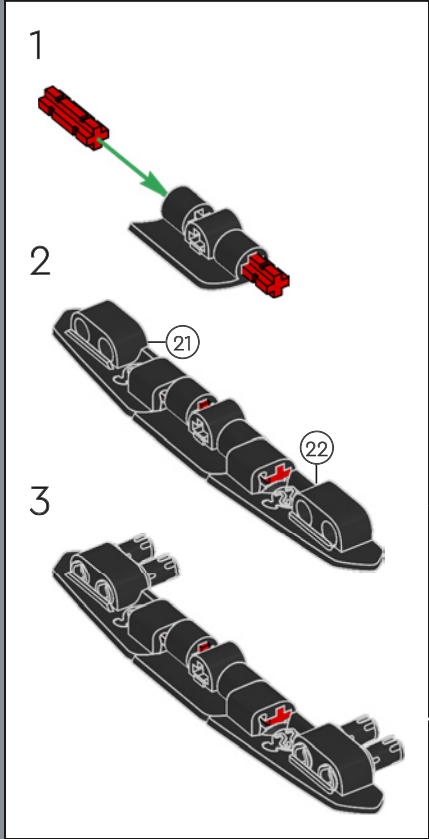



222

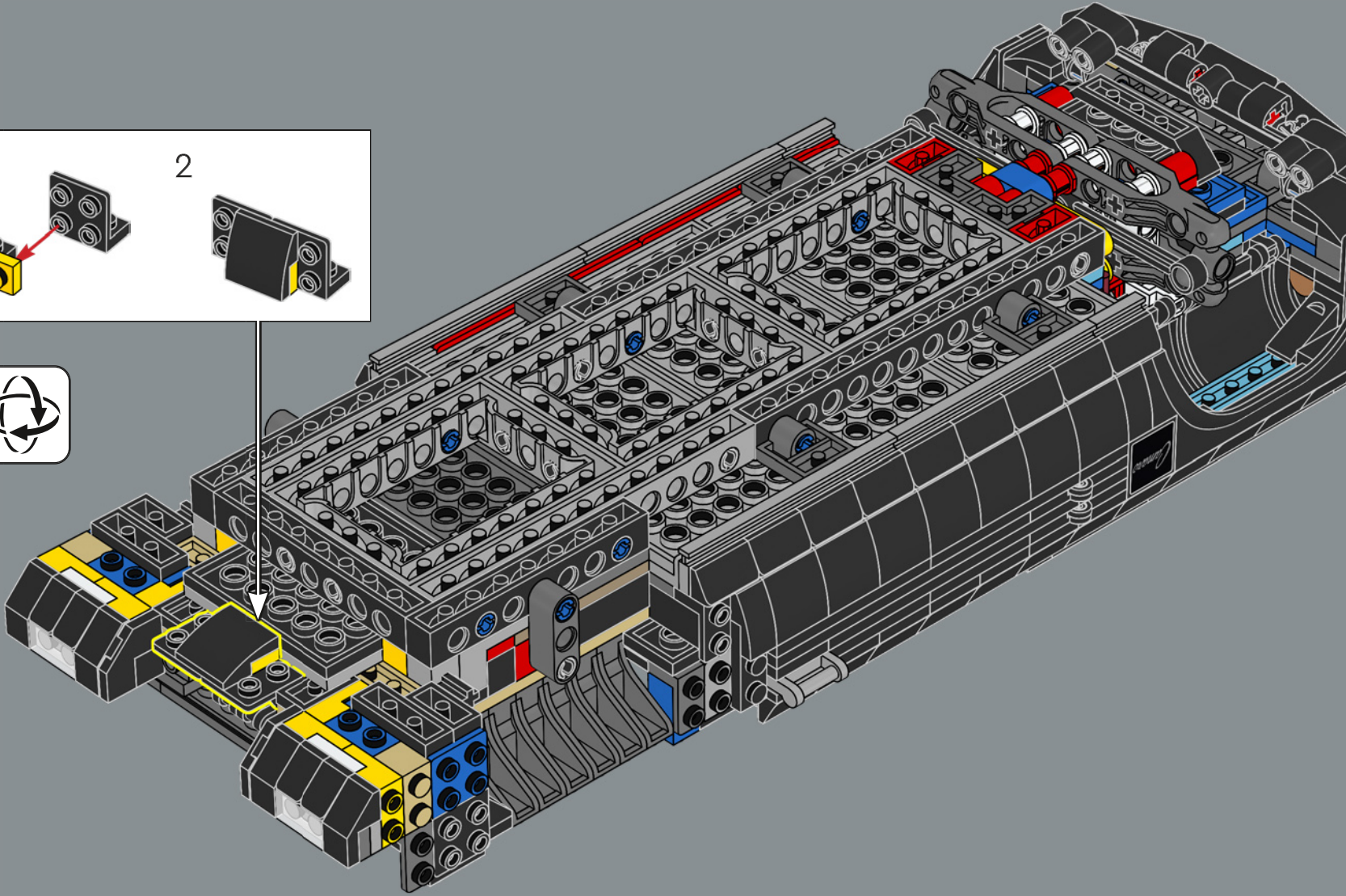
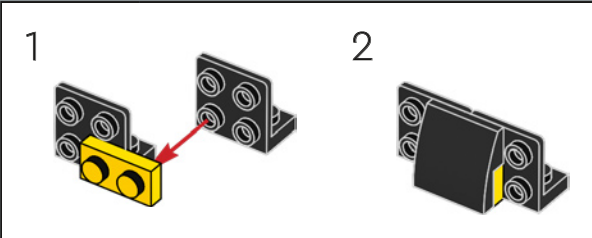

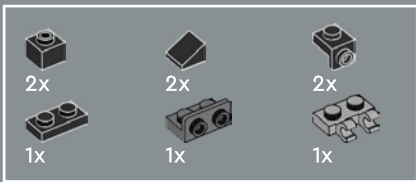

223

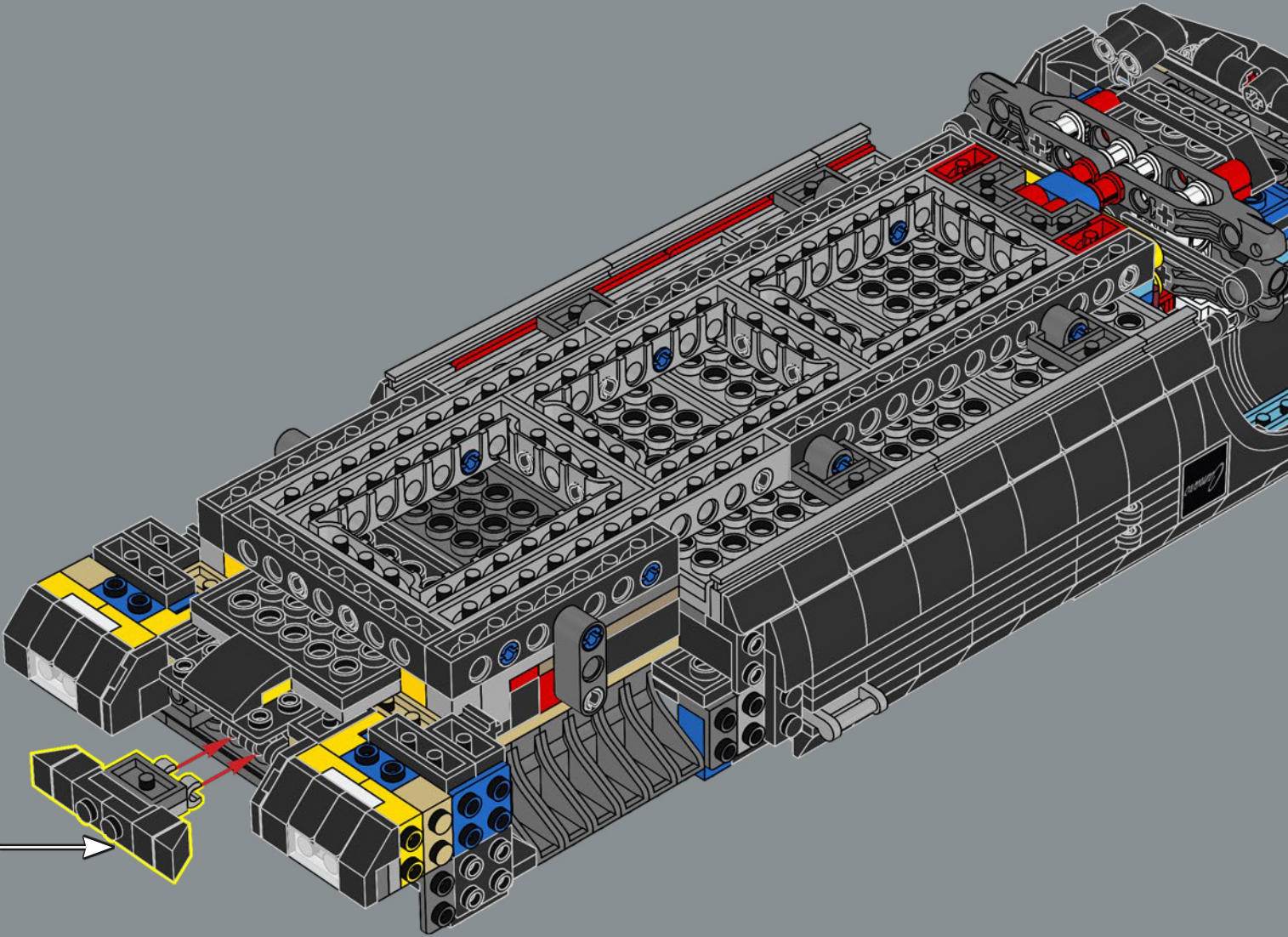
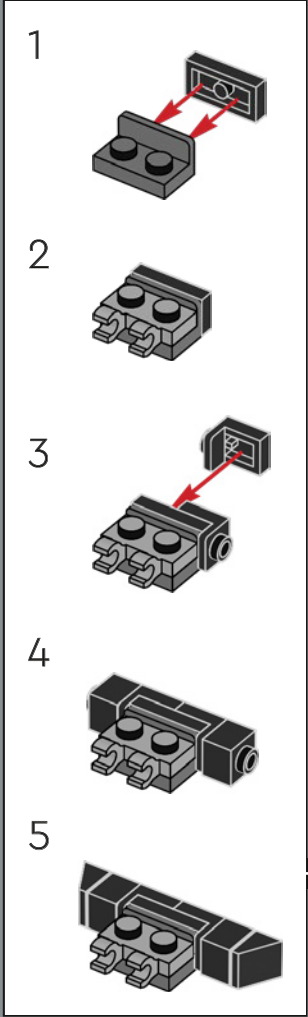

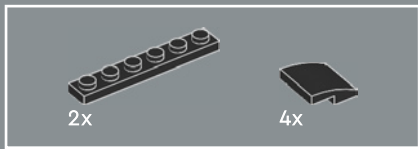

224

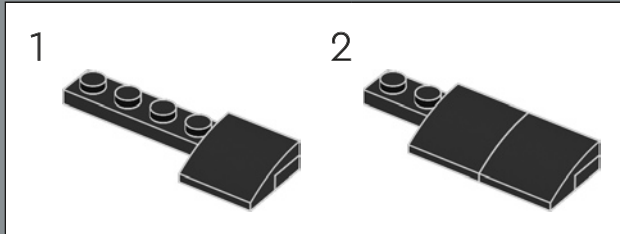

2

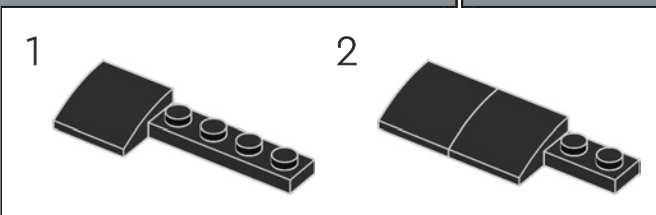
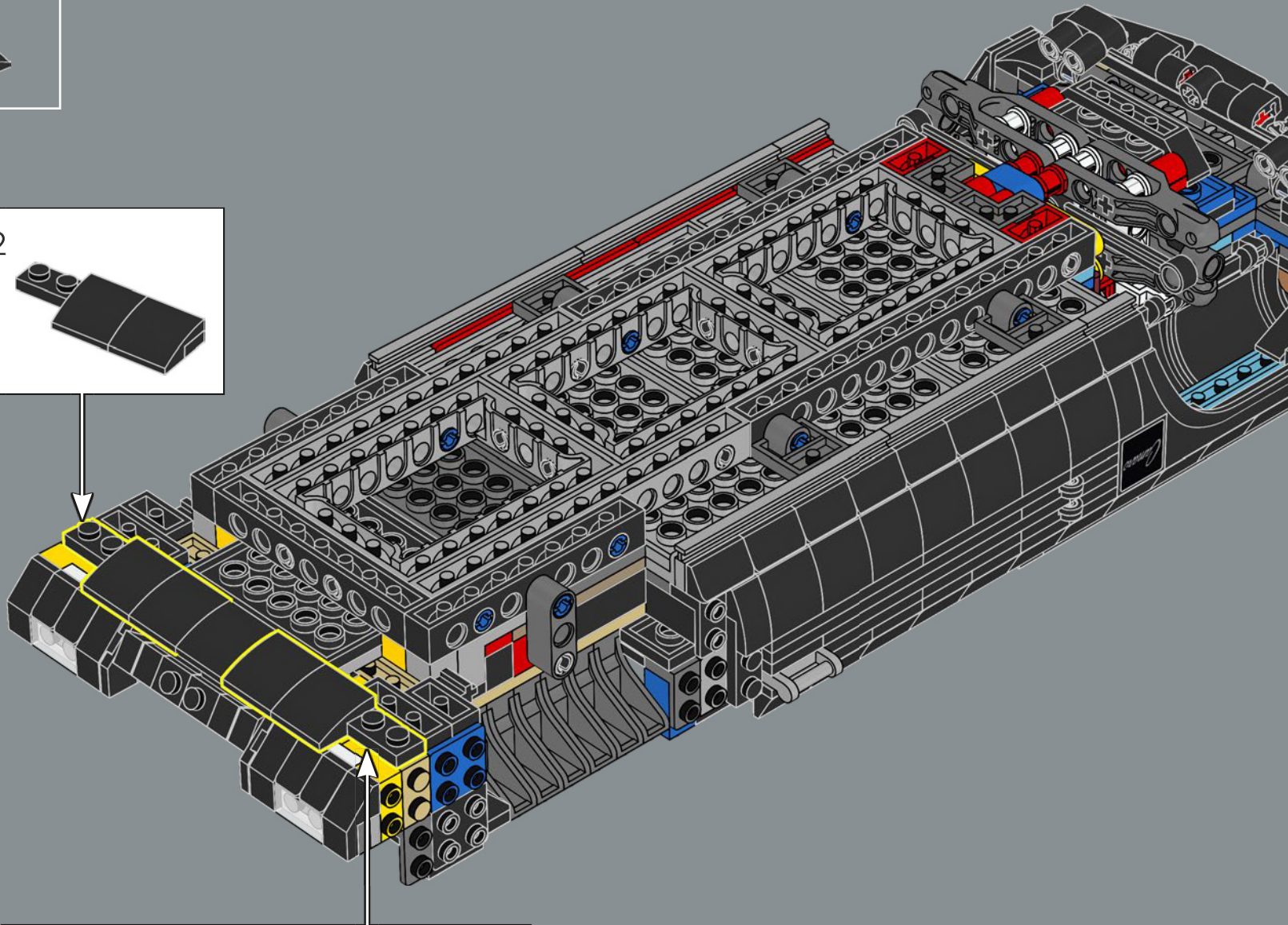
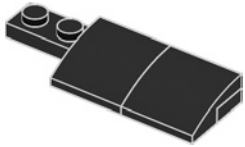

2

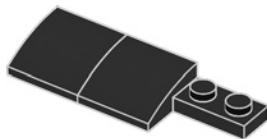



225

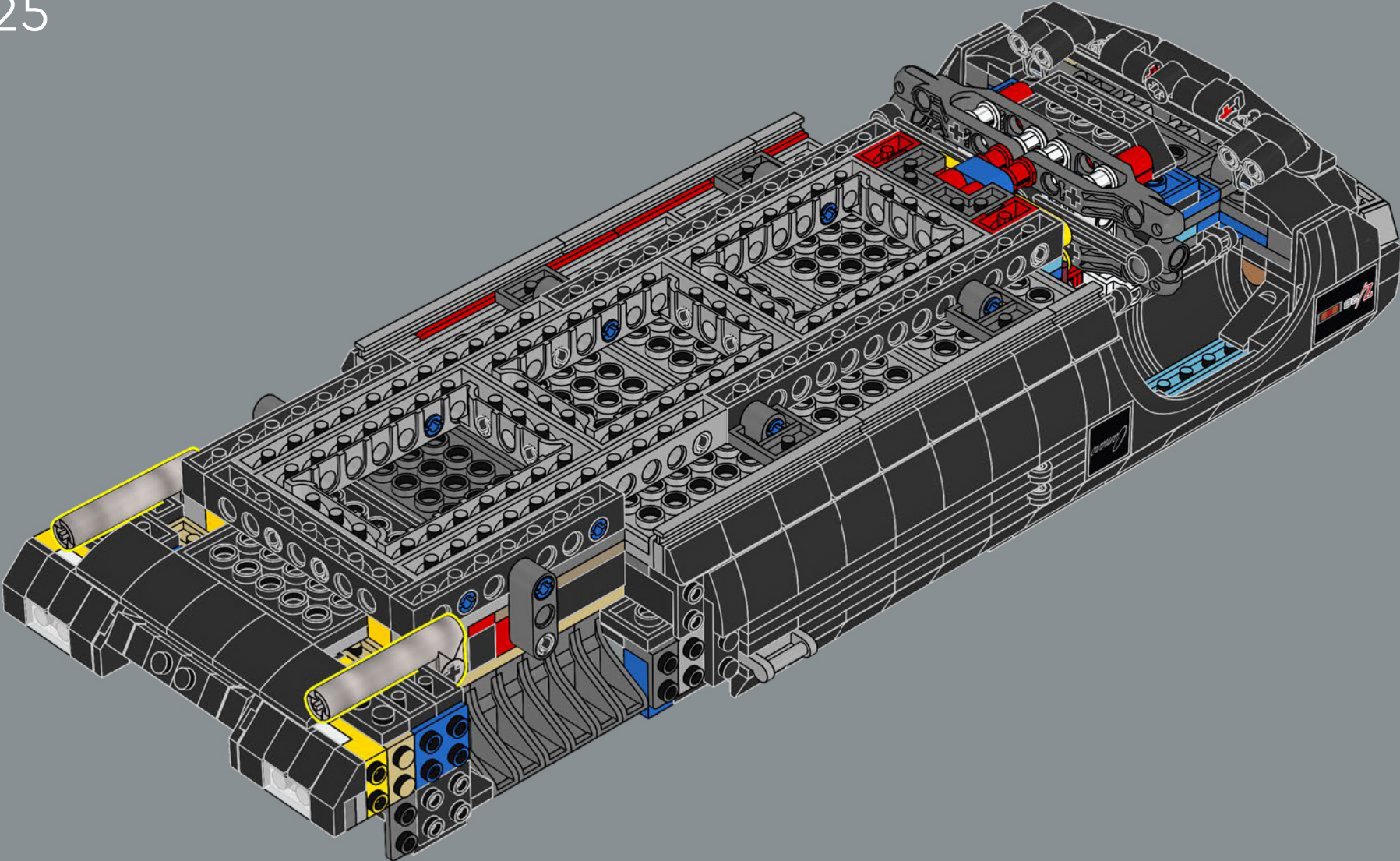

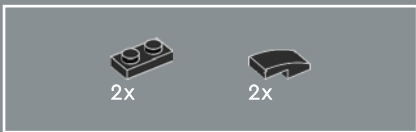

226

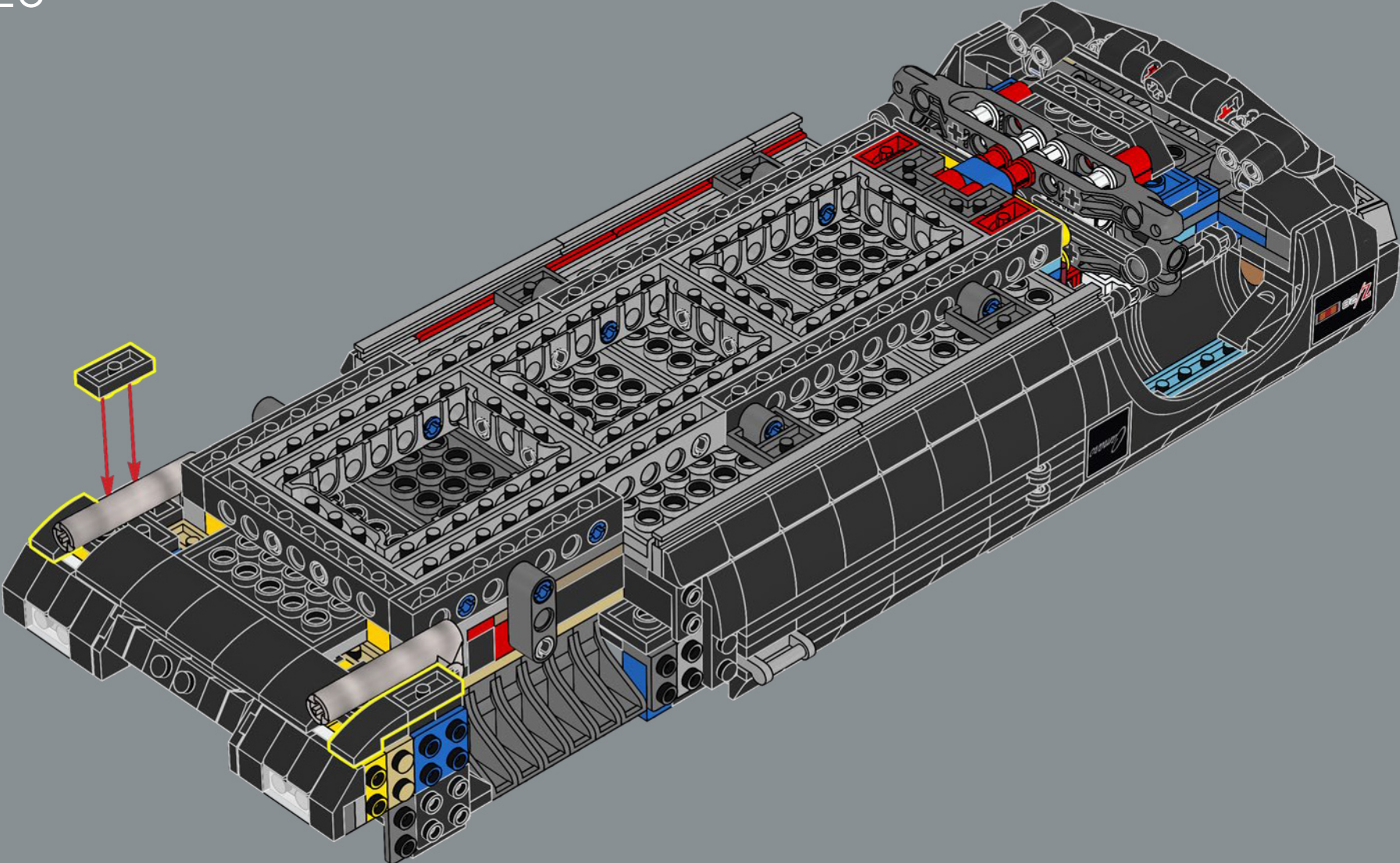

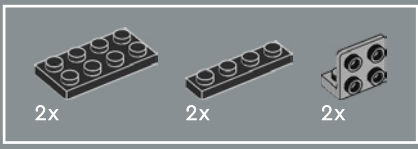

227

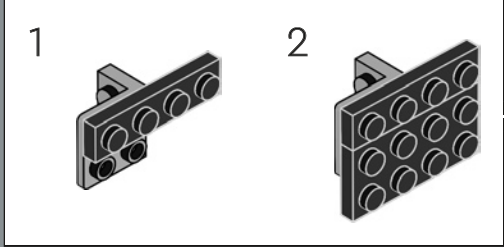
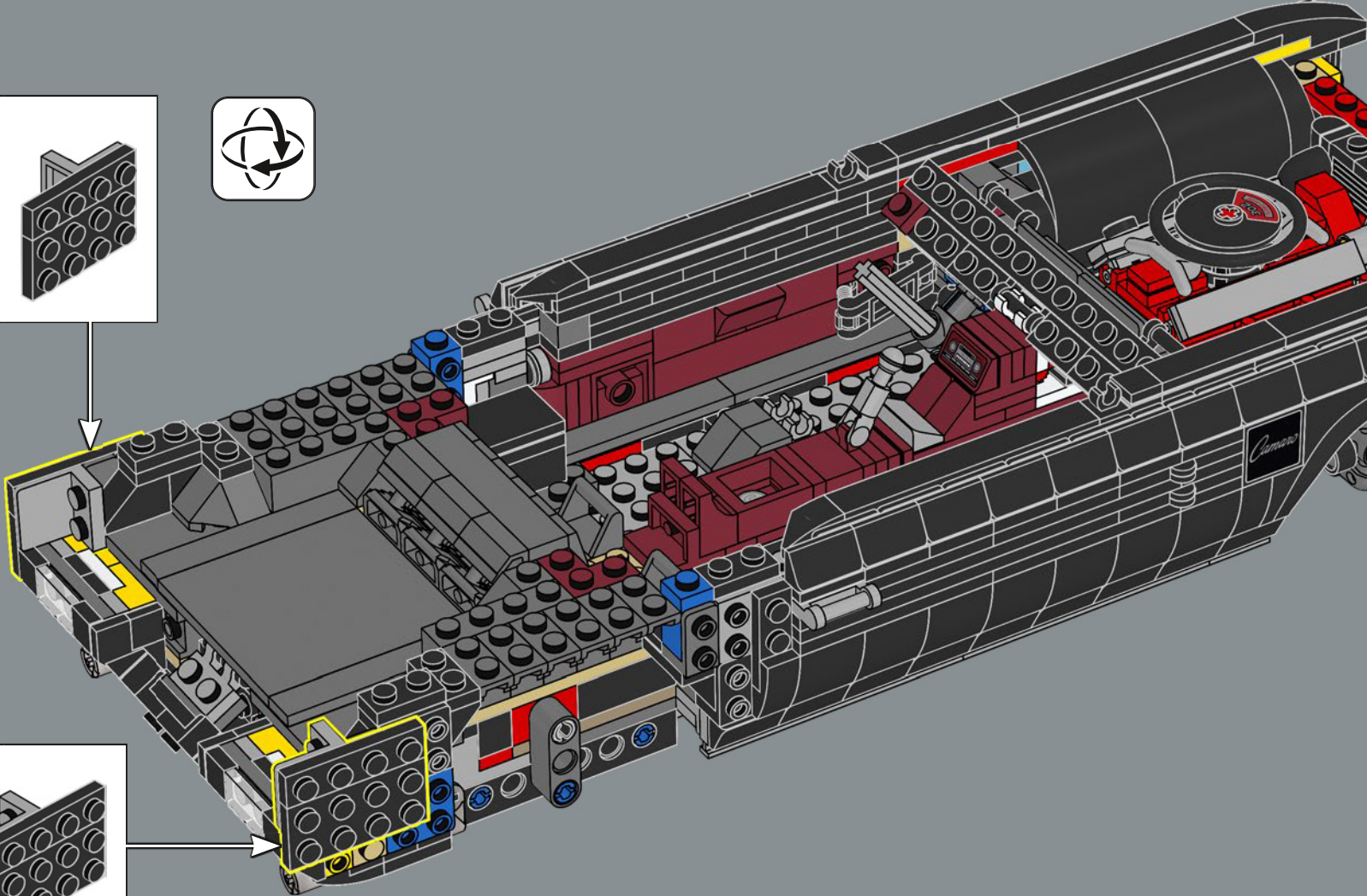
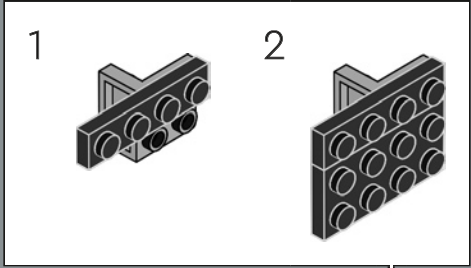

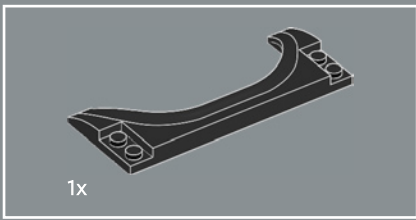

228

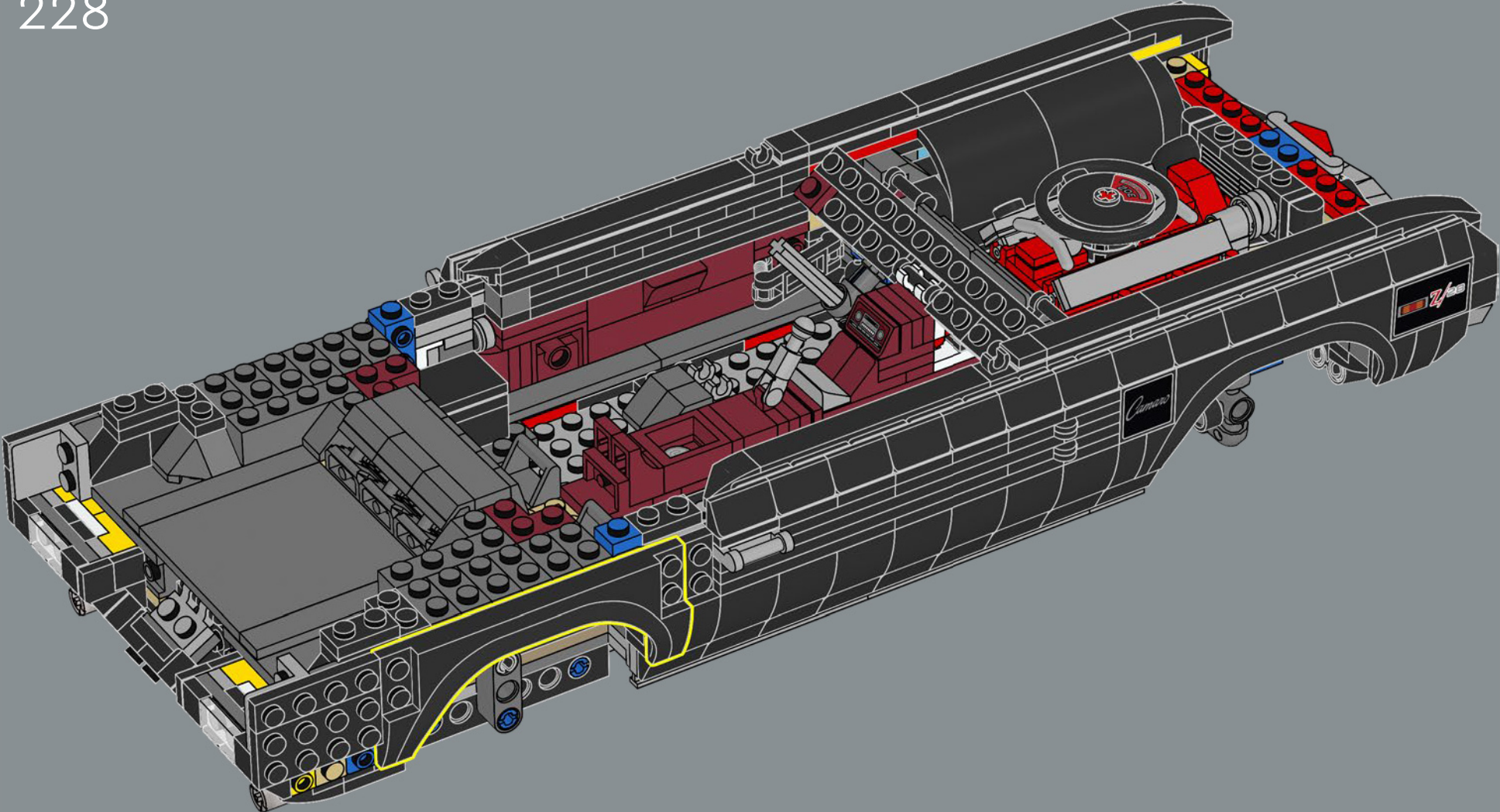

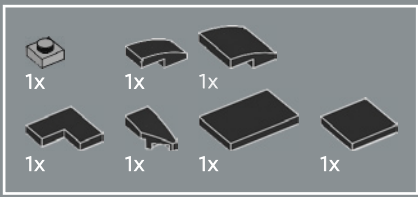

229

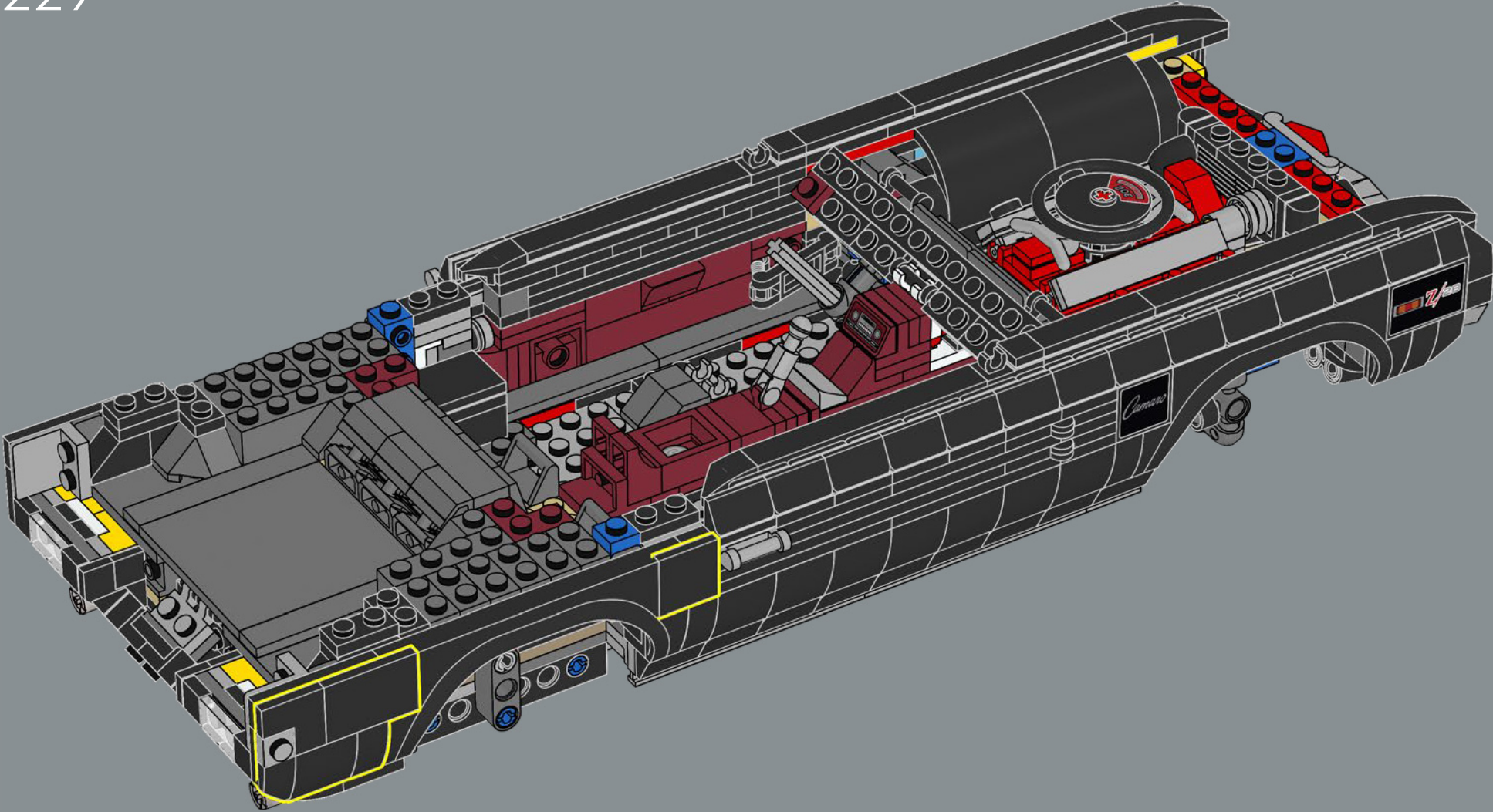

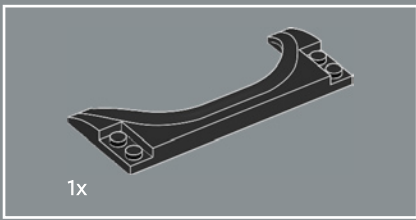

230

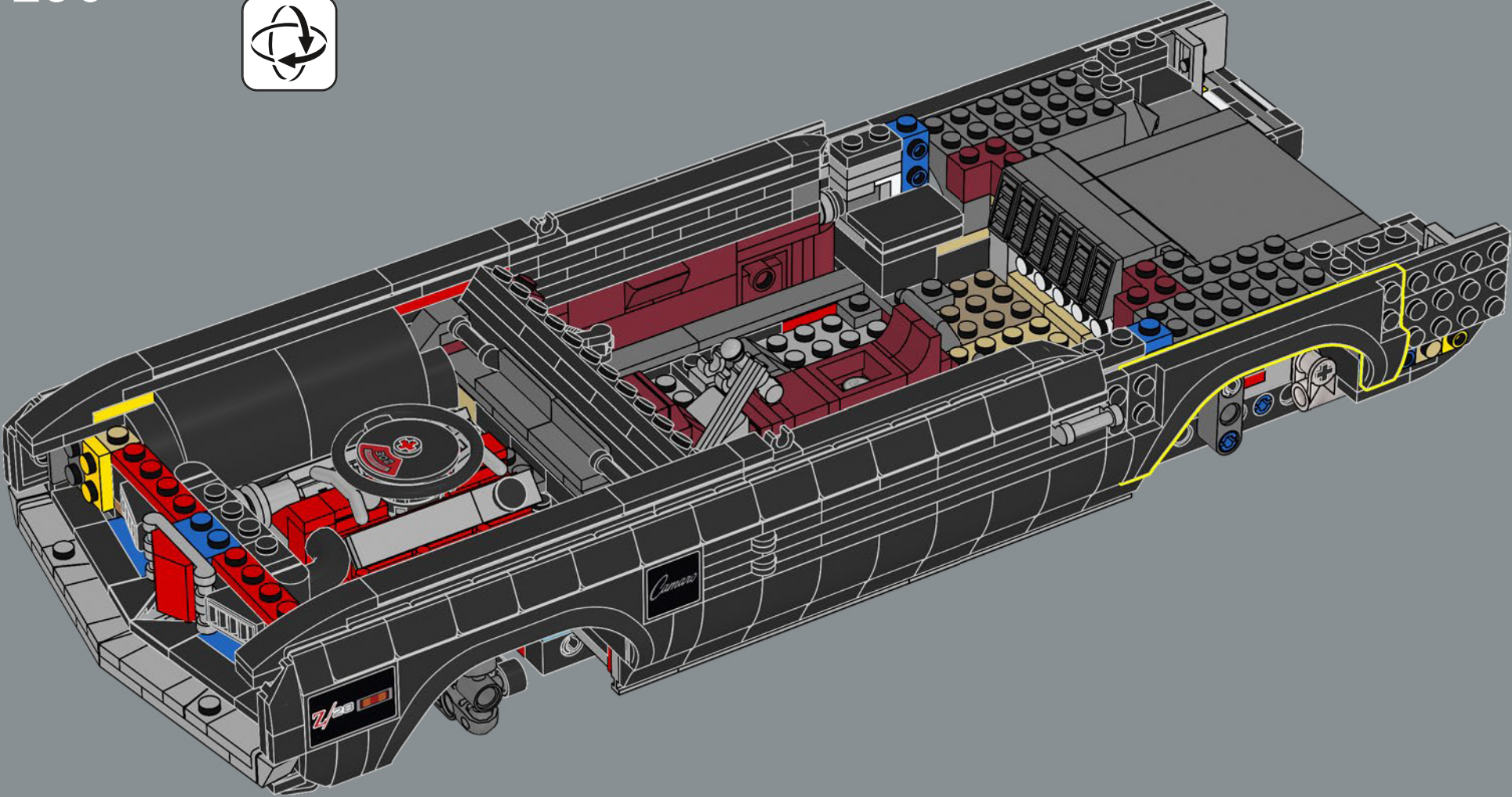

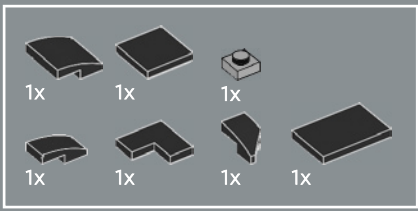

231

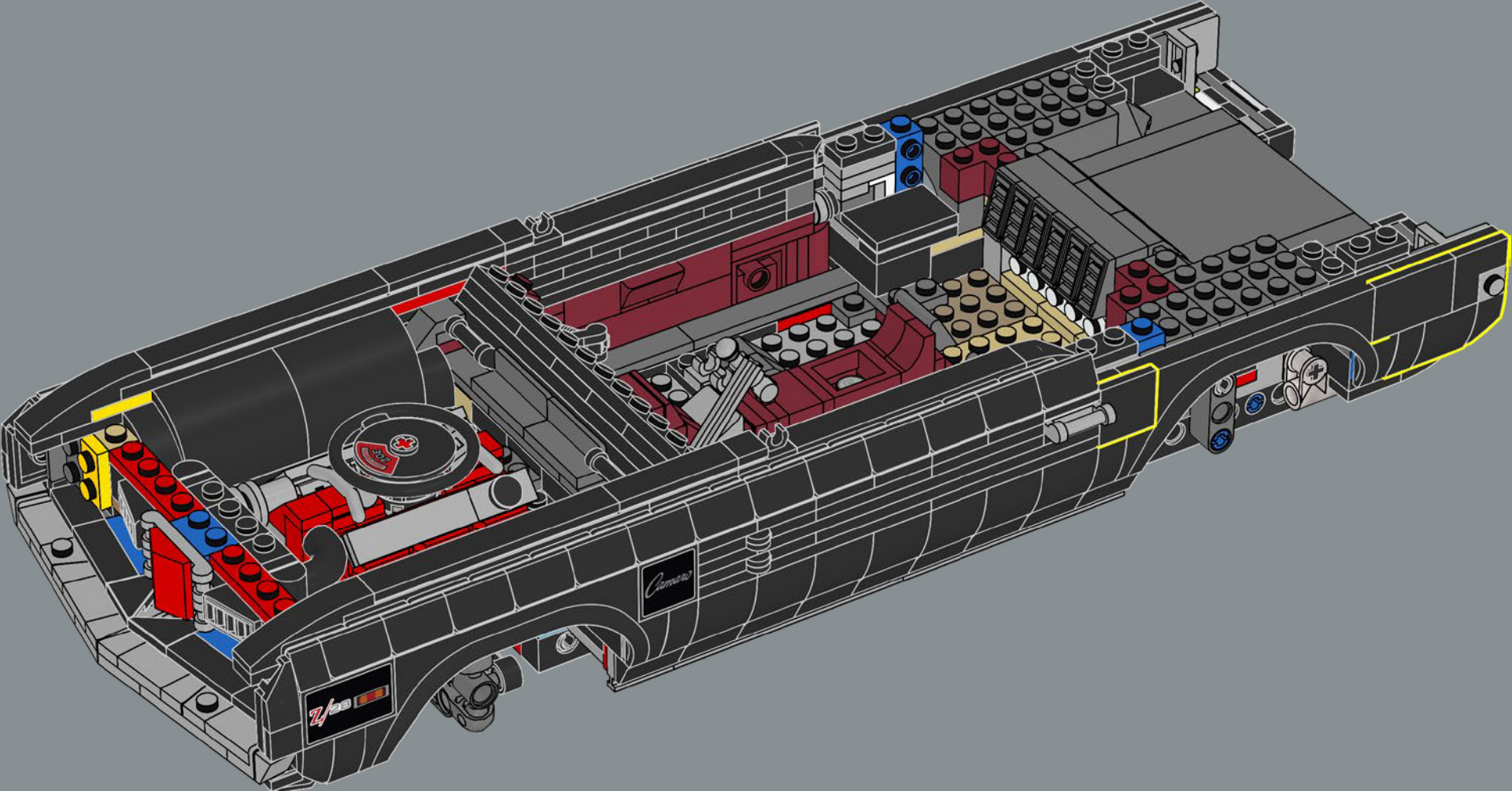

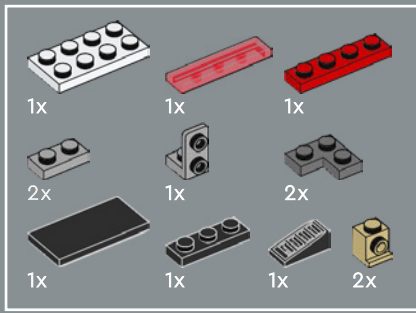

232

1



2



3

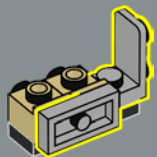

4

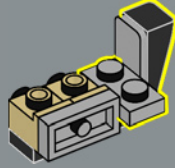

5

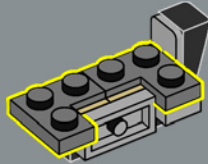

6

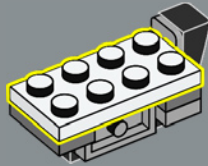

7

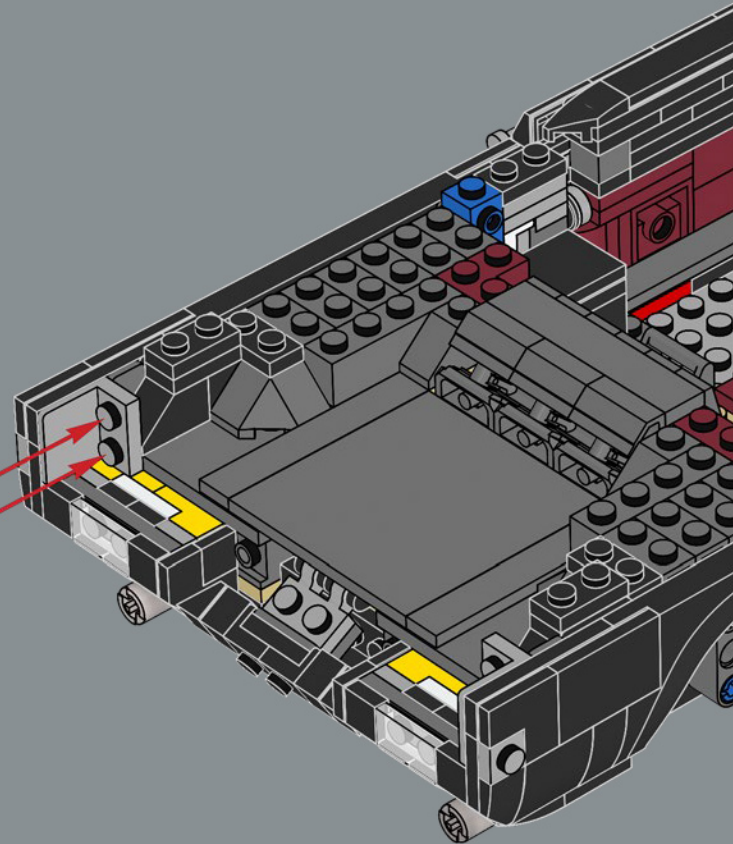
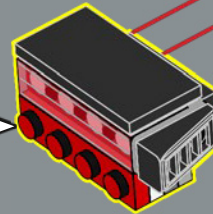
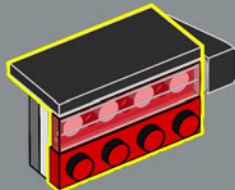

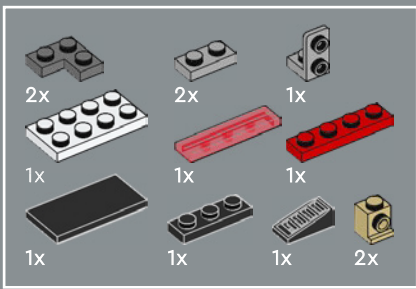

233

1



2



3

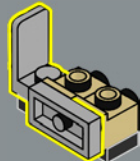

4

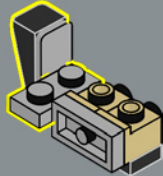

5

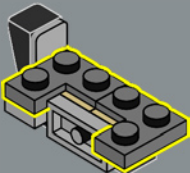

6

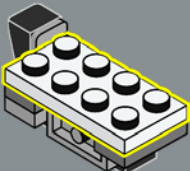

7

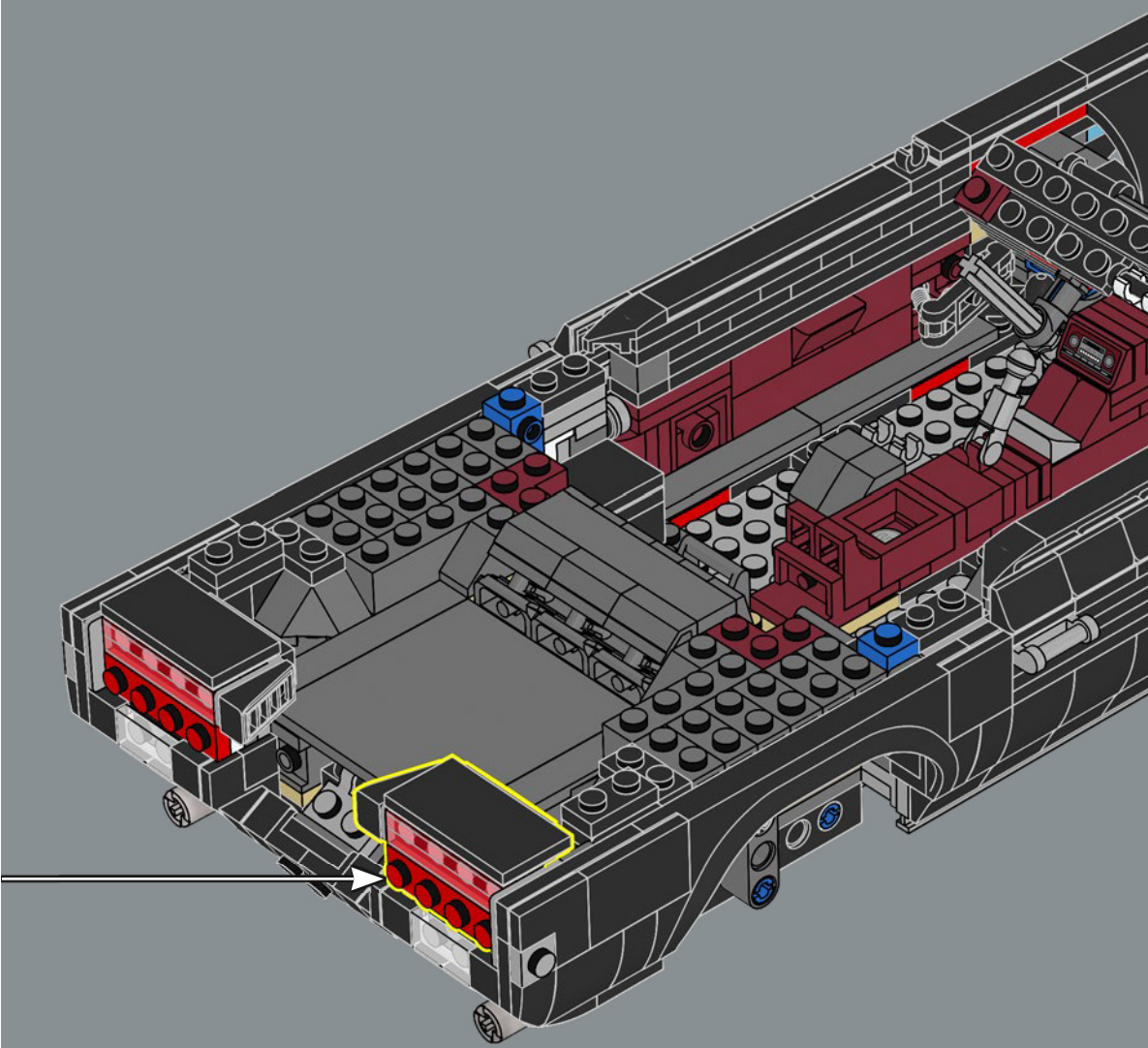
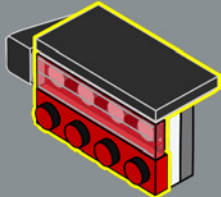

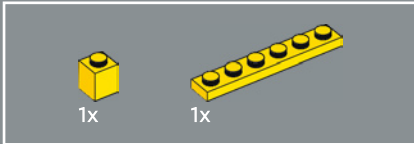
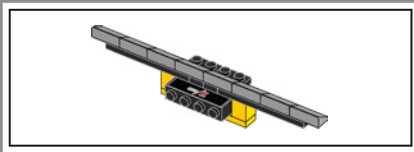

234

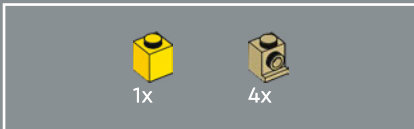
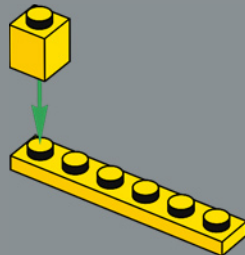

235

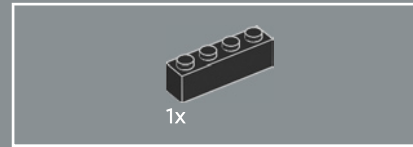
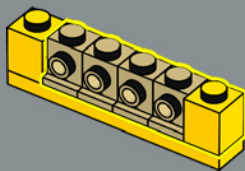

236

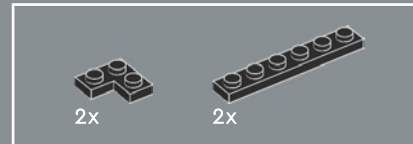
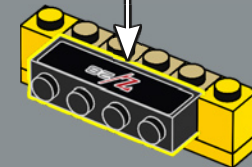
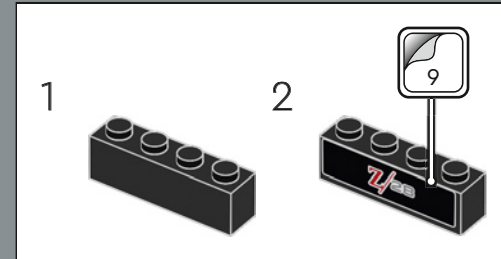

237

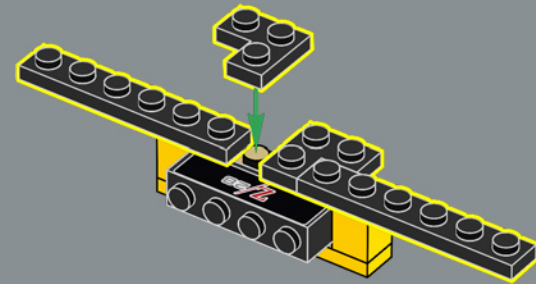



2x

238

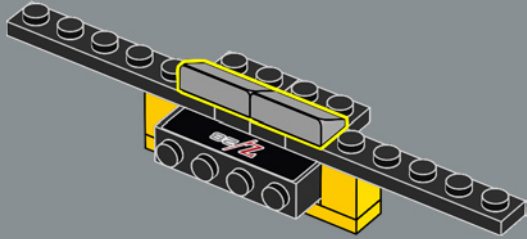

6x

239

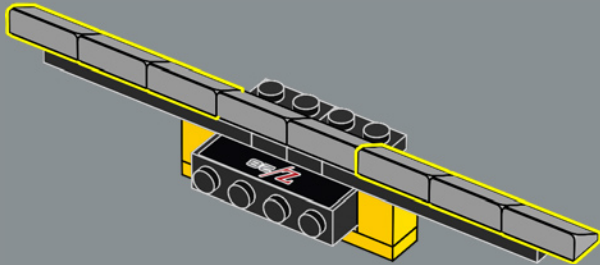

240

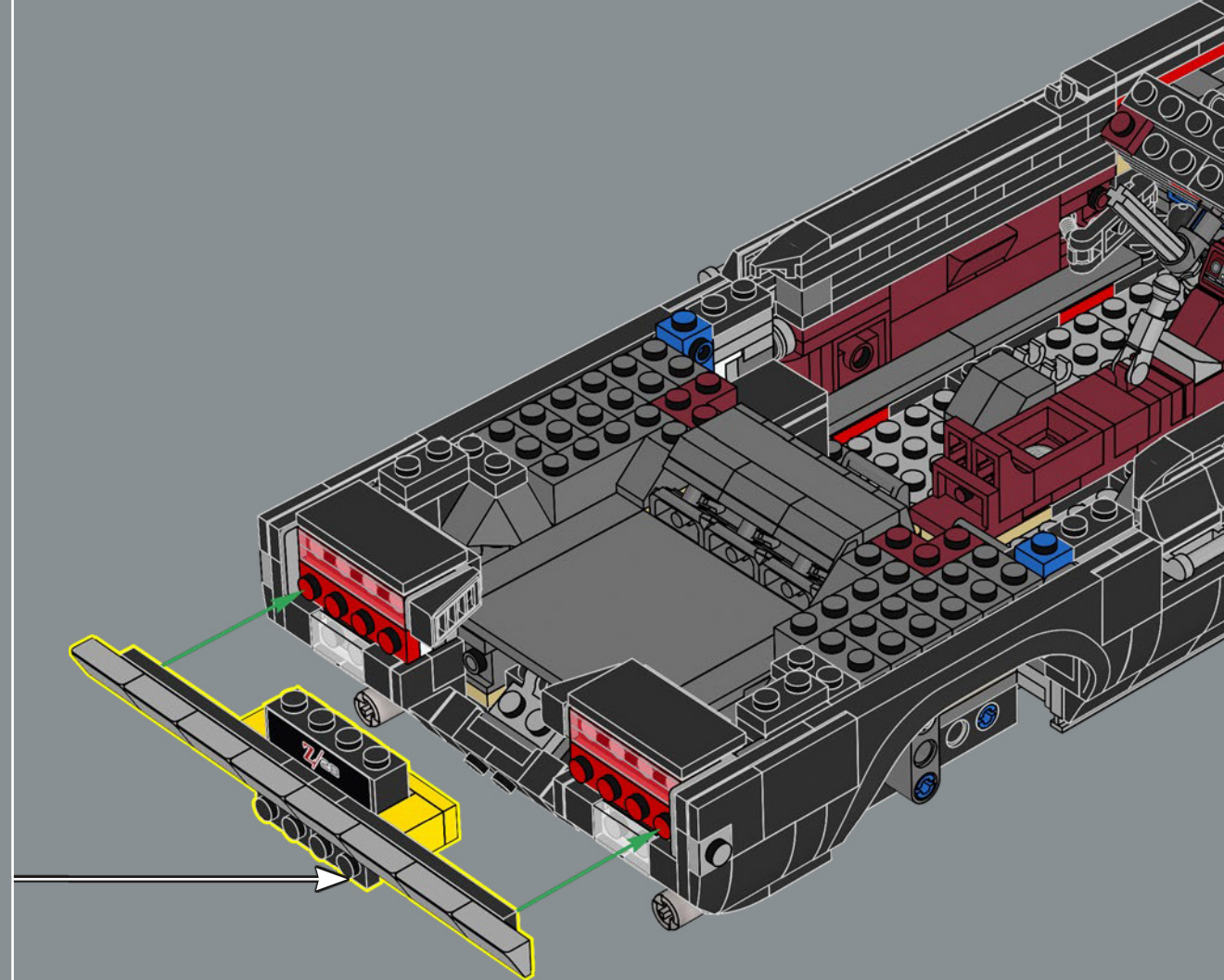

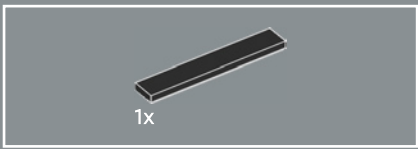

241

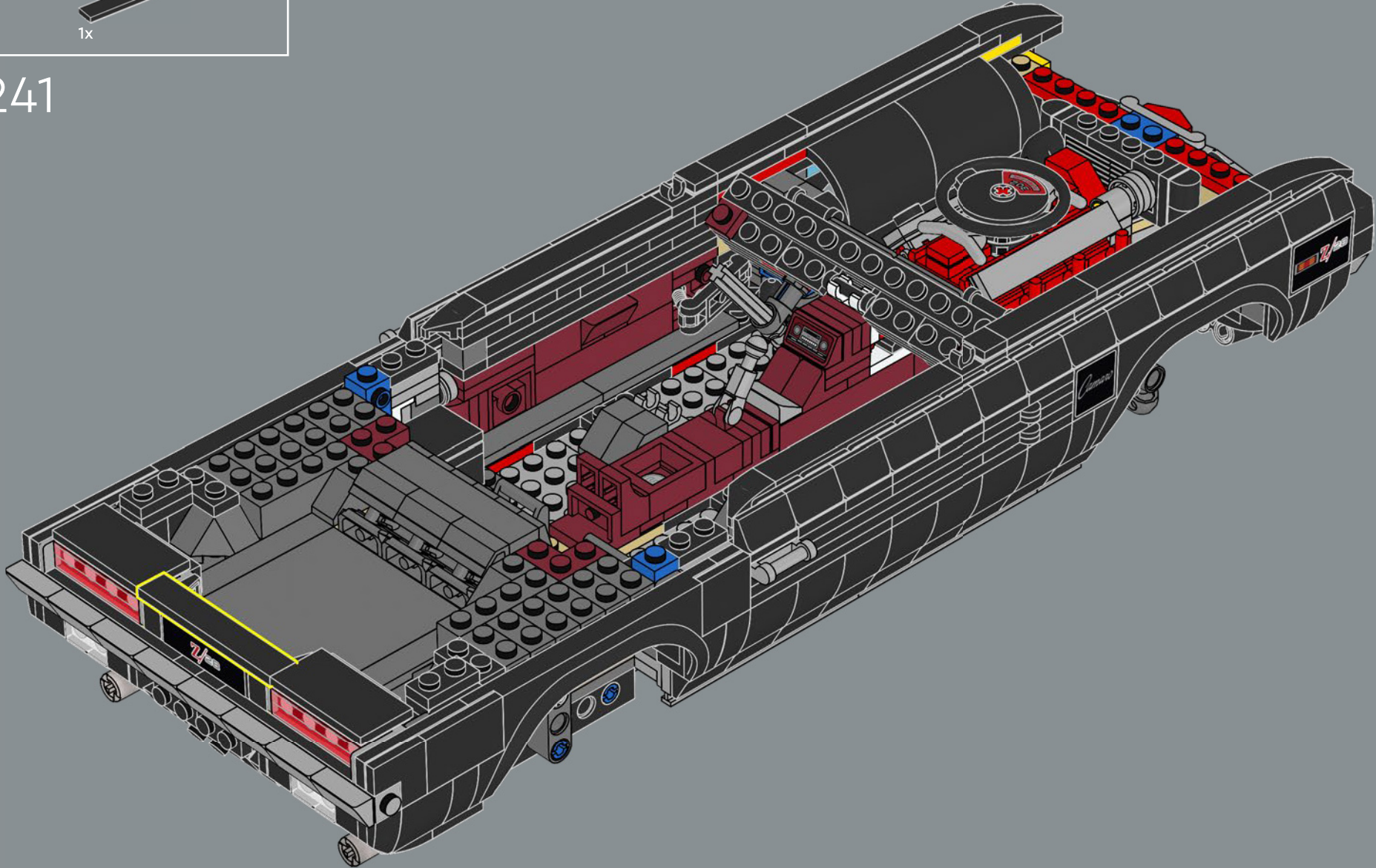



242

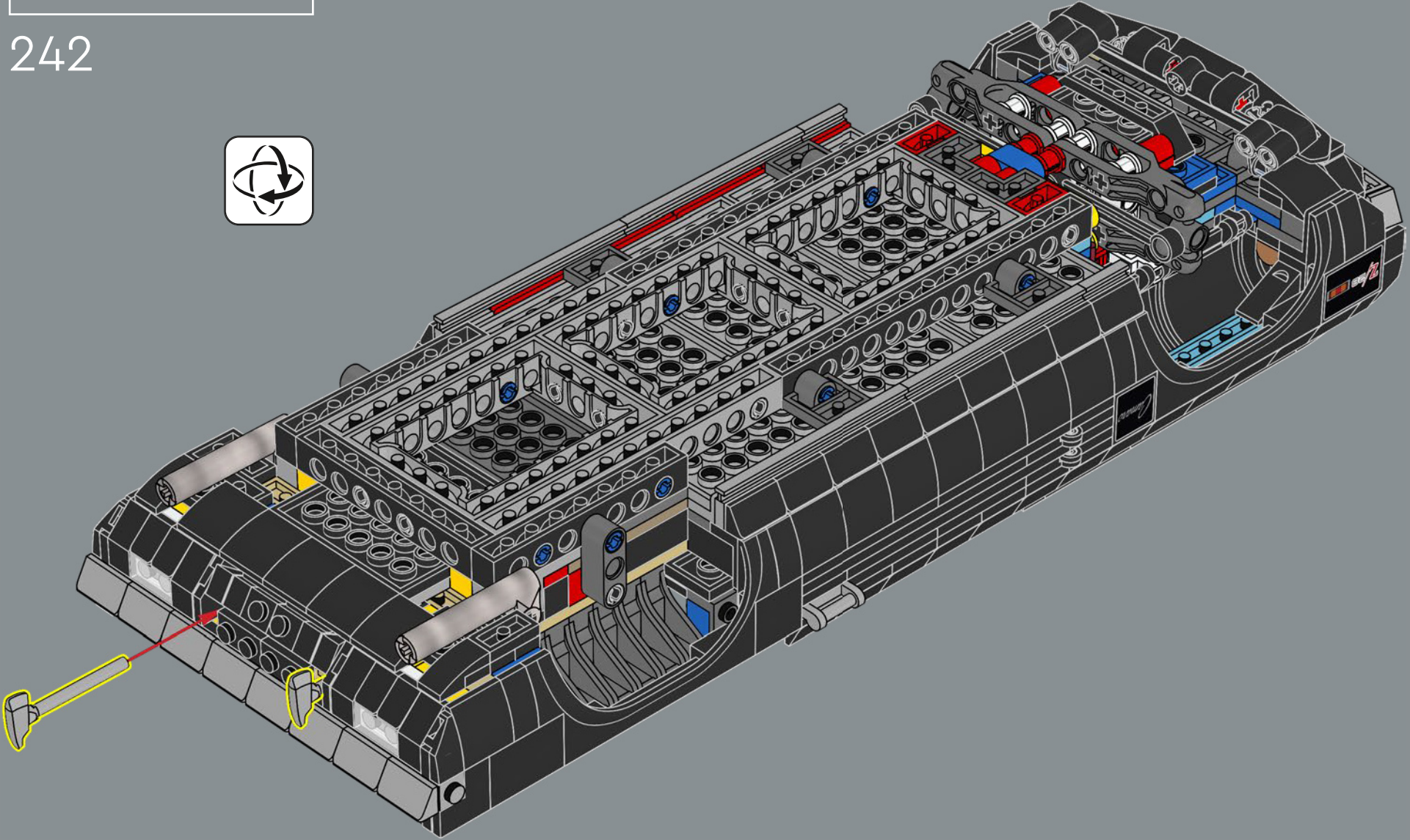

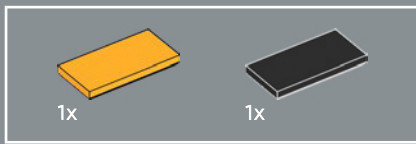

Contrairement à la plupart des Chevrolet, les 3 premières générations de Camaro n'ont pas été construites à Detroit, mais dans les usines de Norwood, Ohio et Van Nuys, en Californie.

243

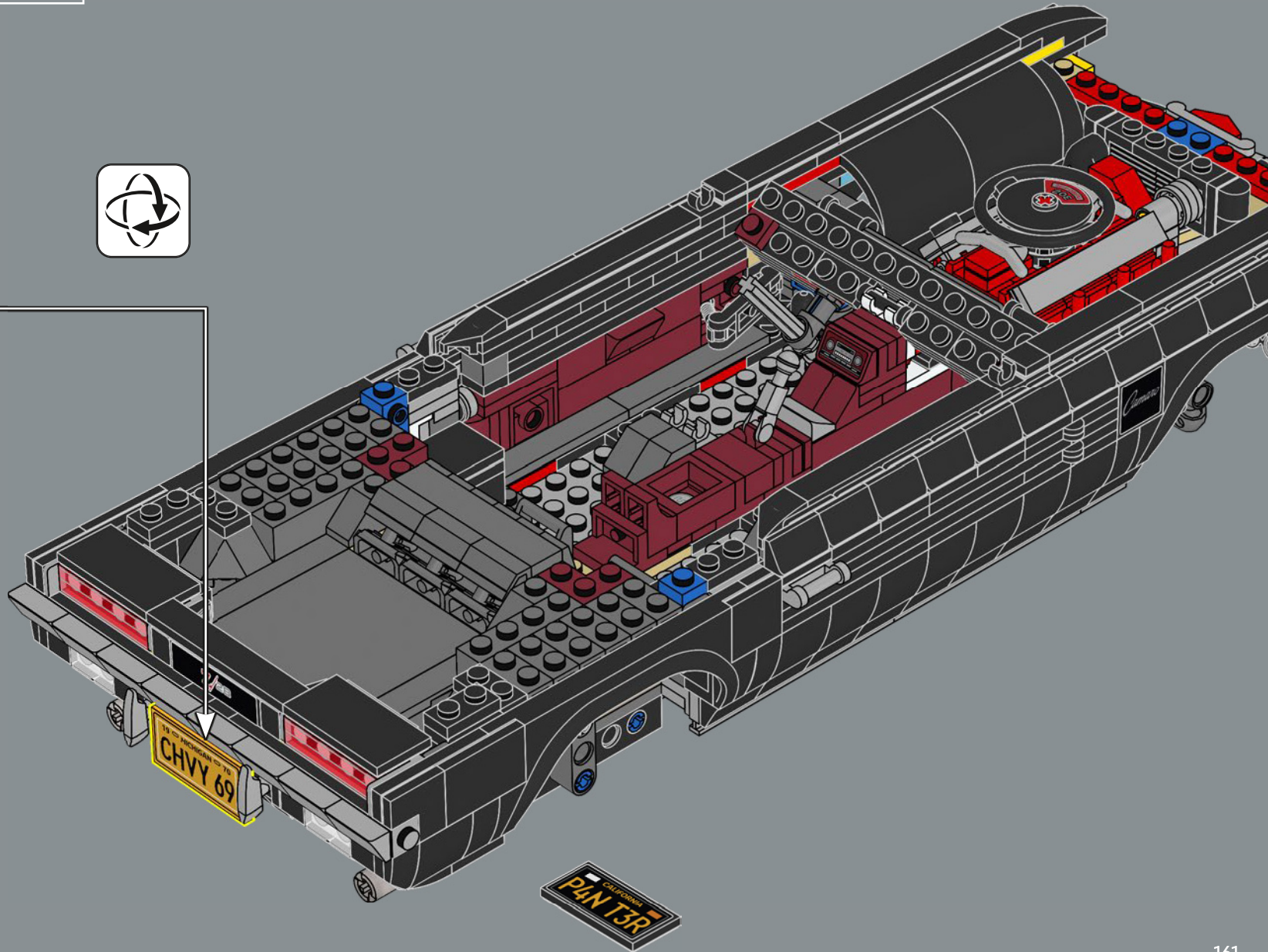
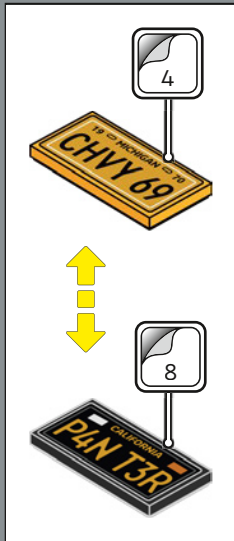

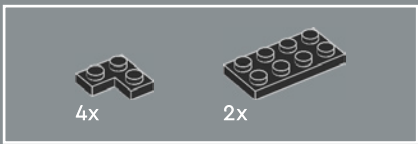

244

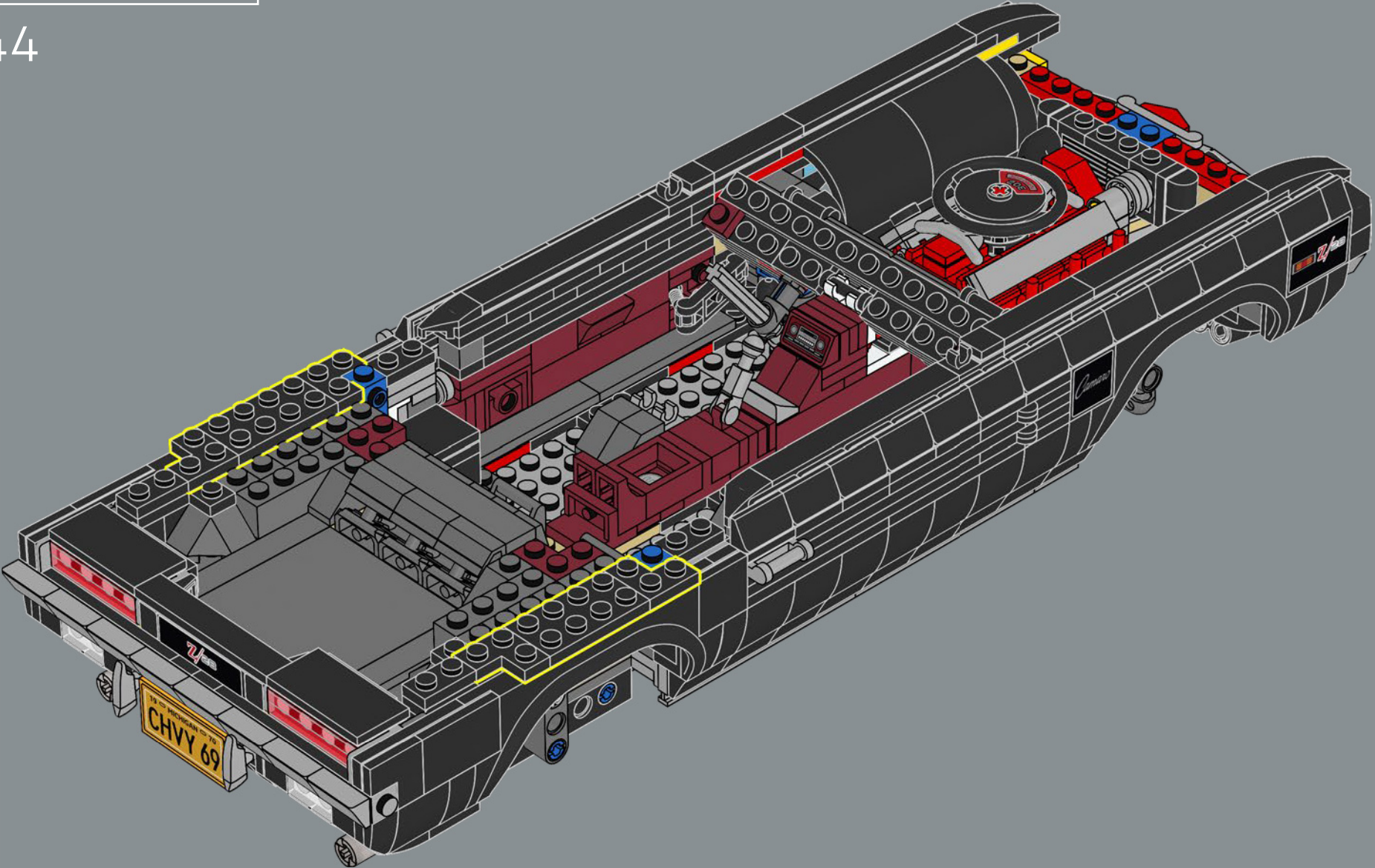

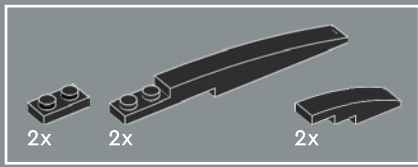

245

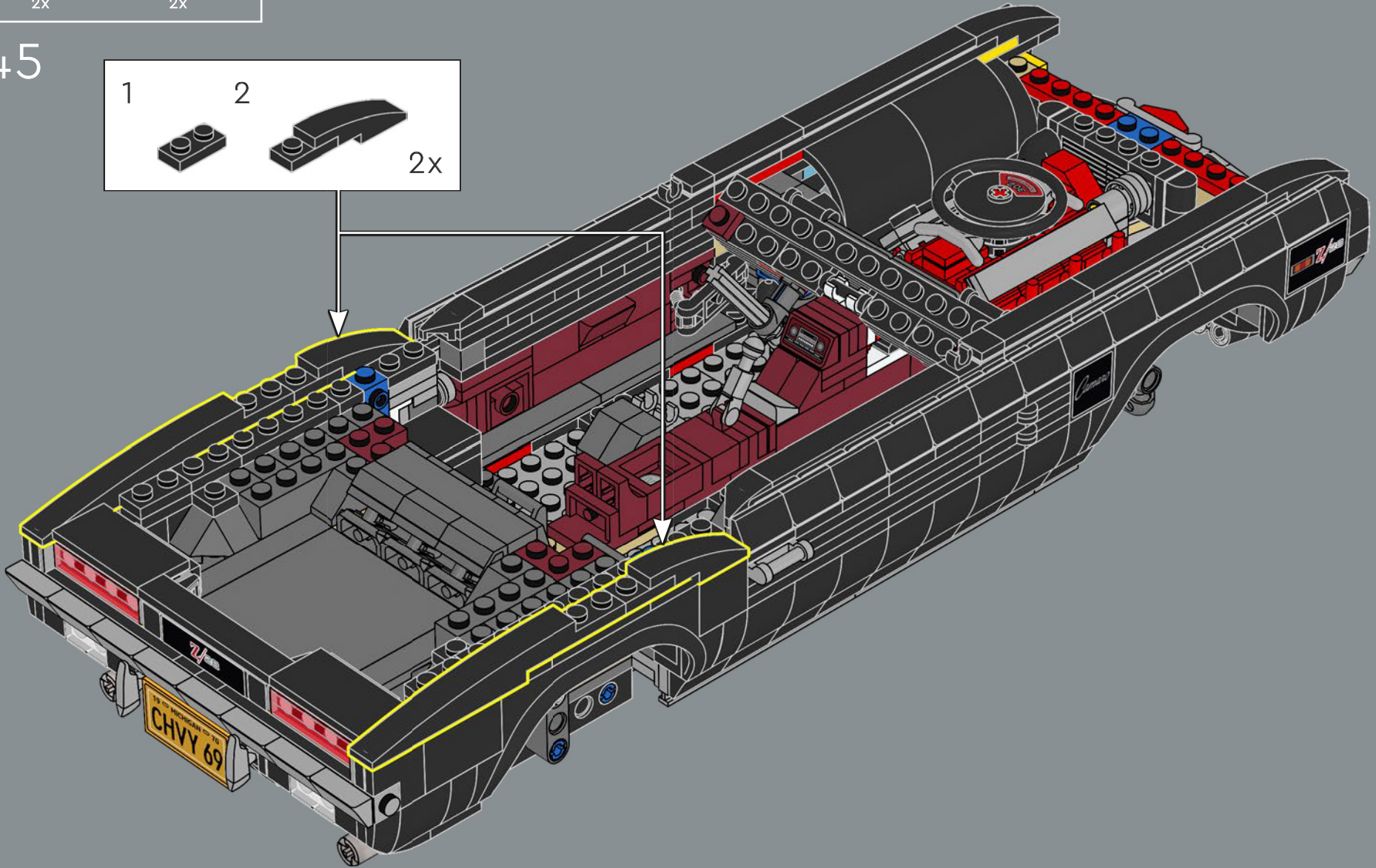
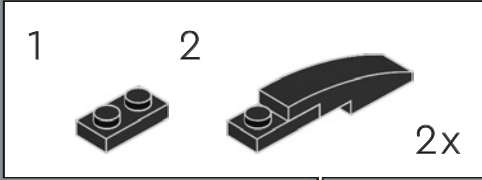

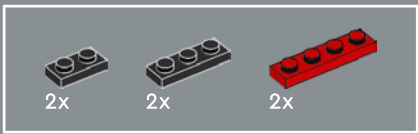

246

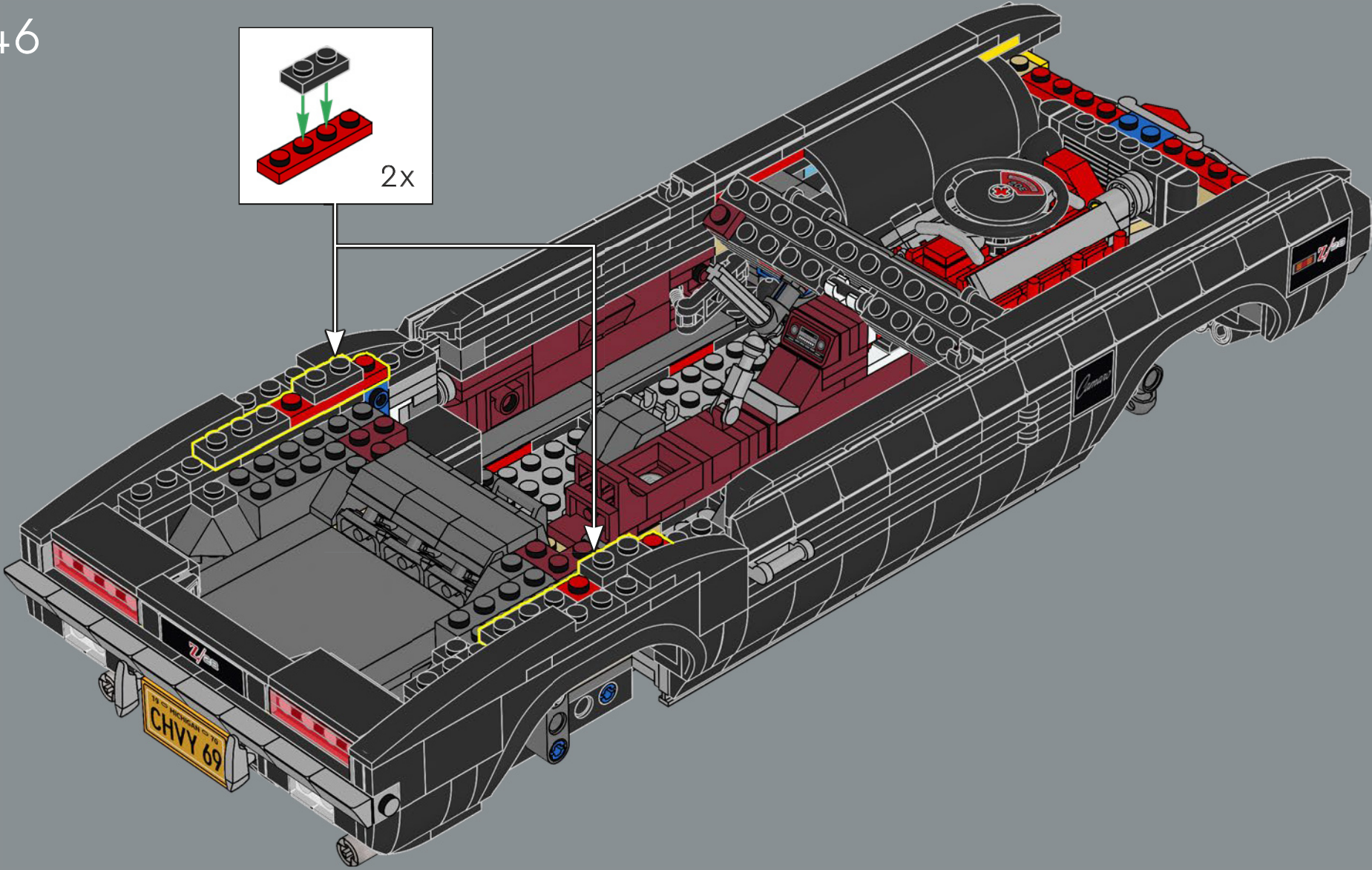
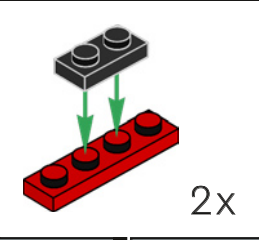

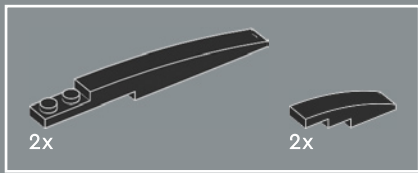

247

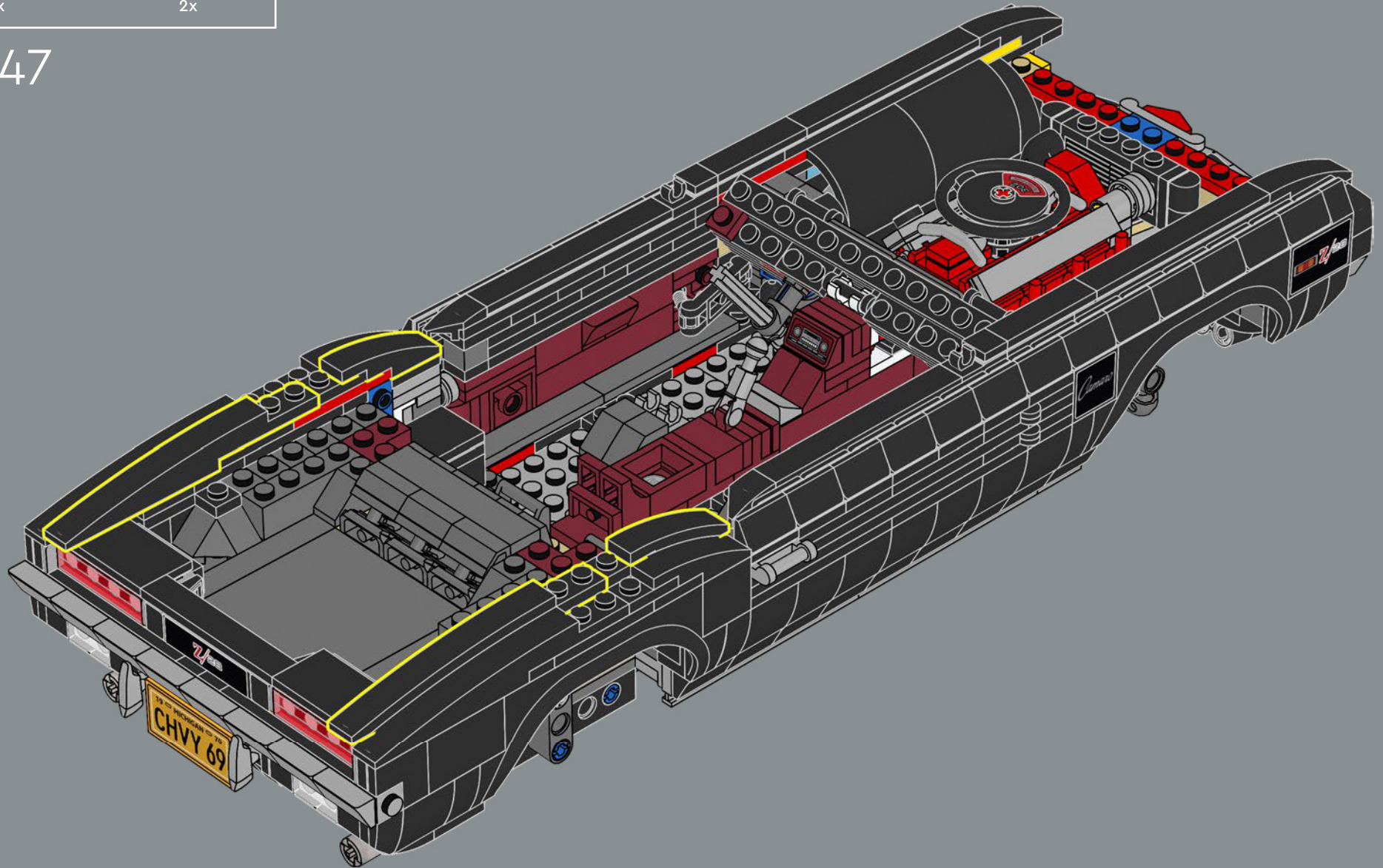

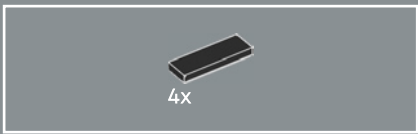

248

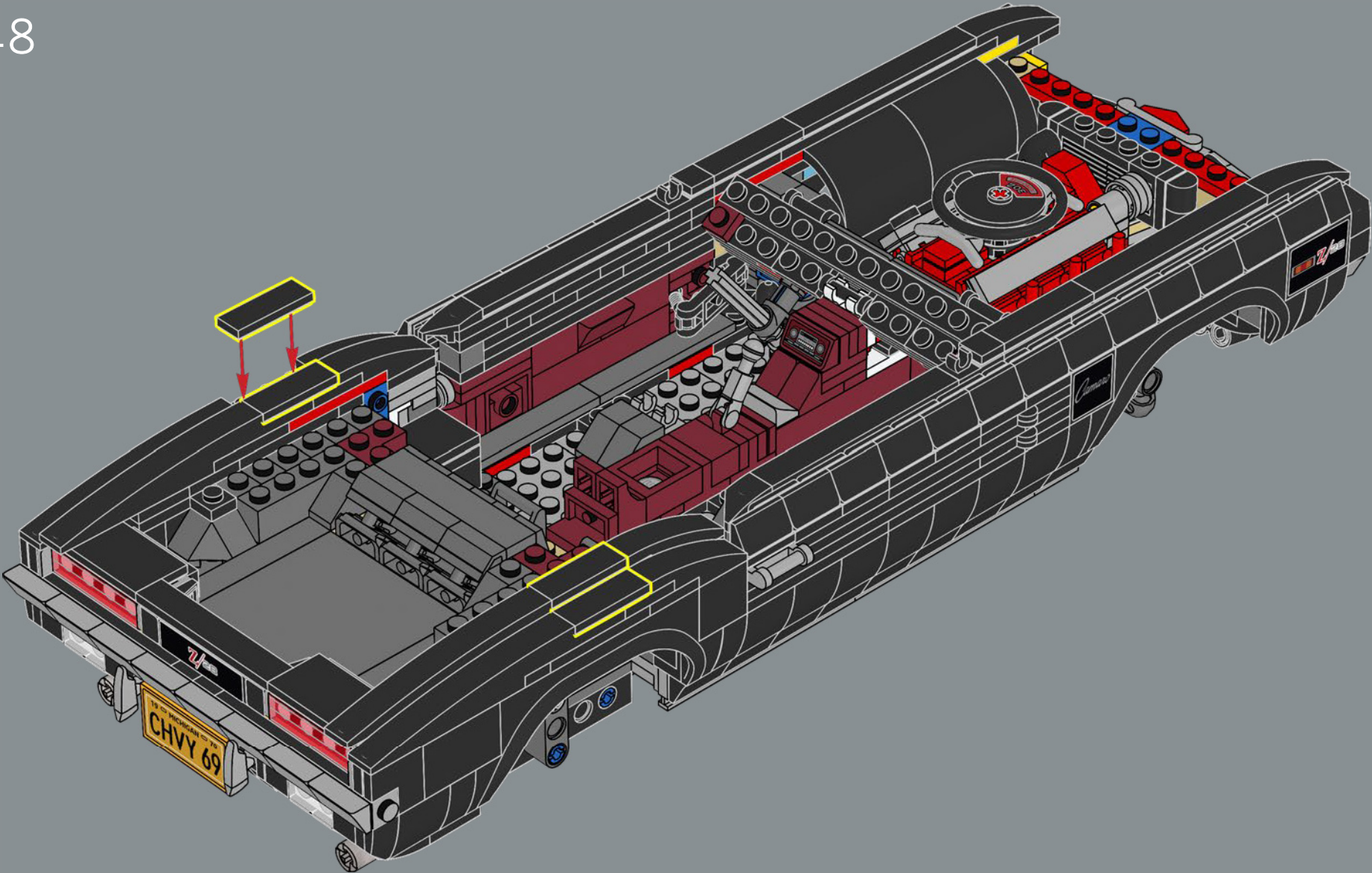

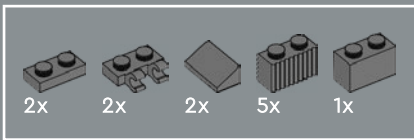

249

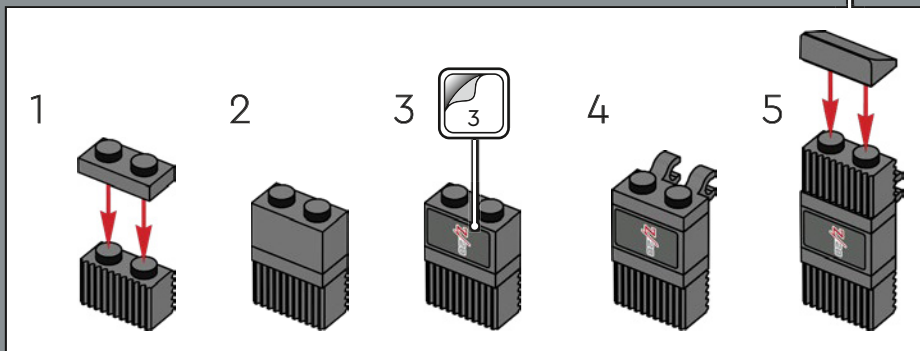
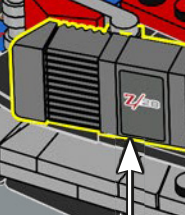
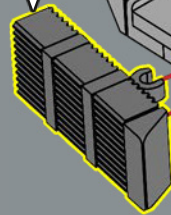
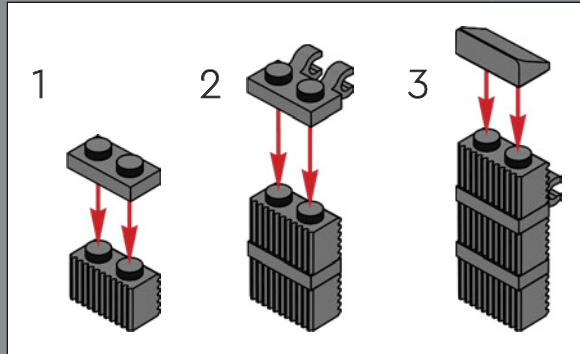

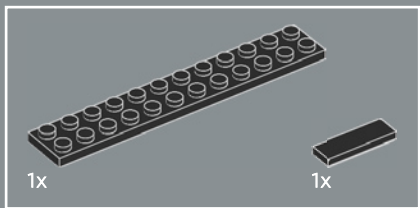

250

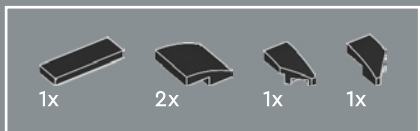
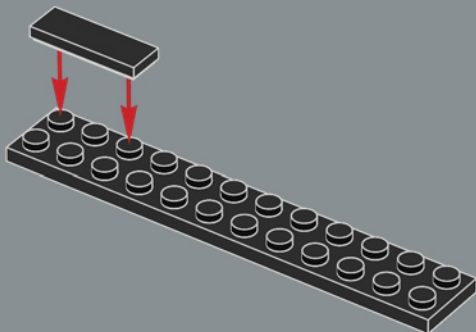

251

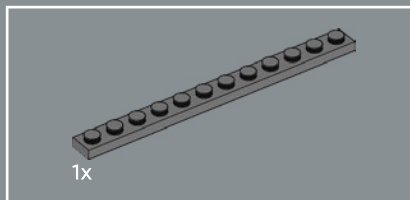
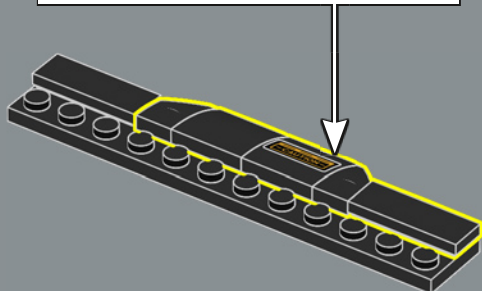
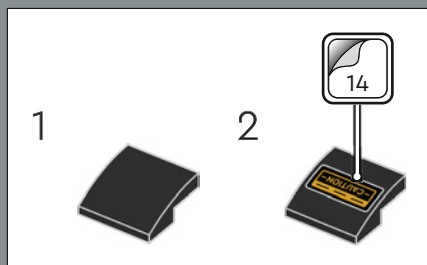

252

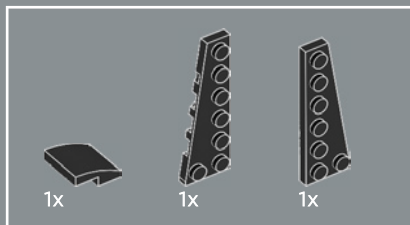
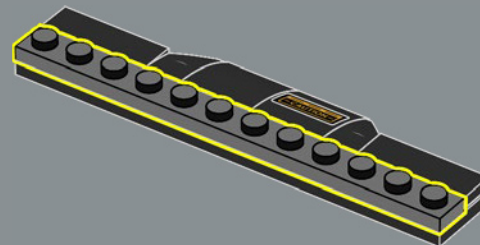

253

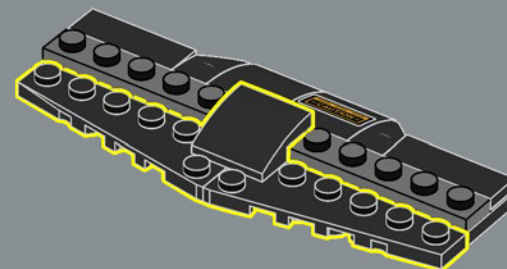



254

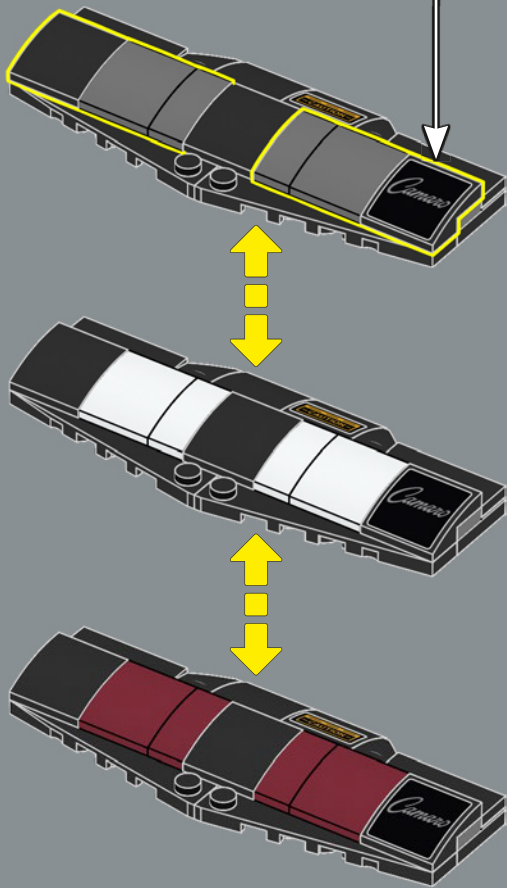
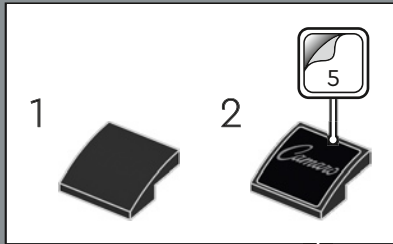

255

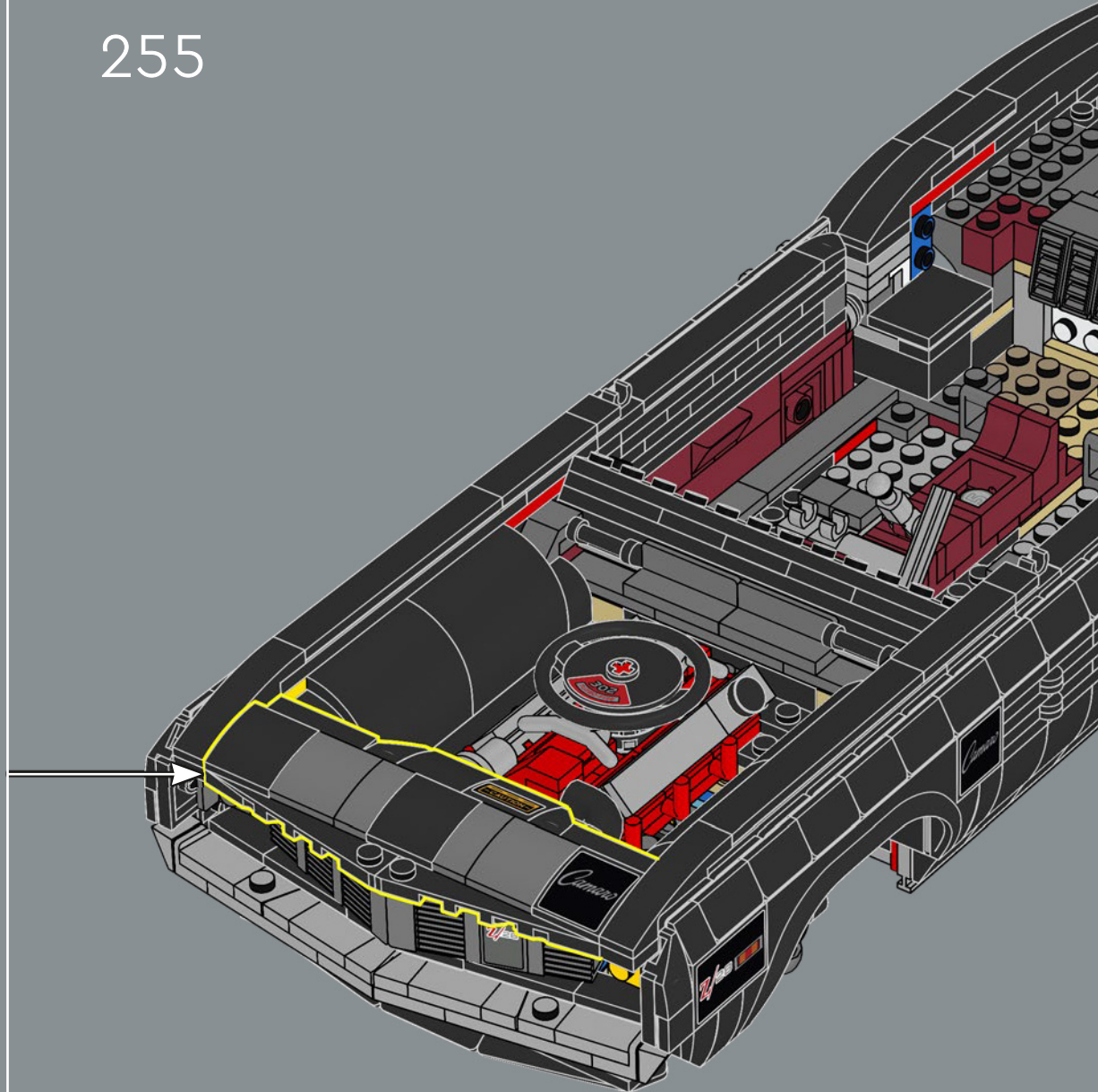

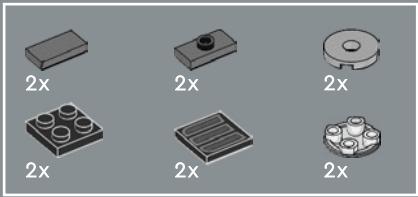

256

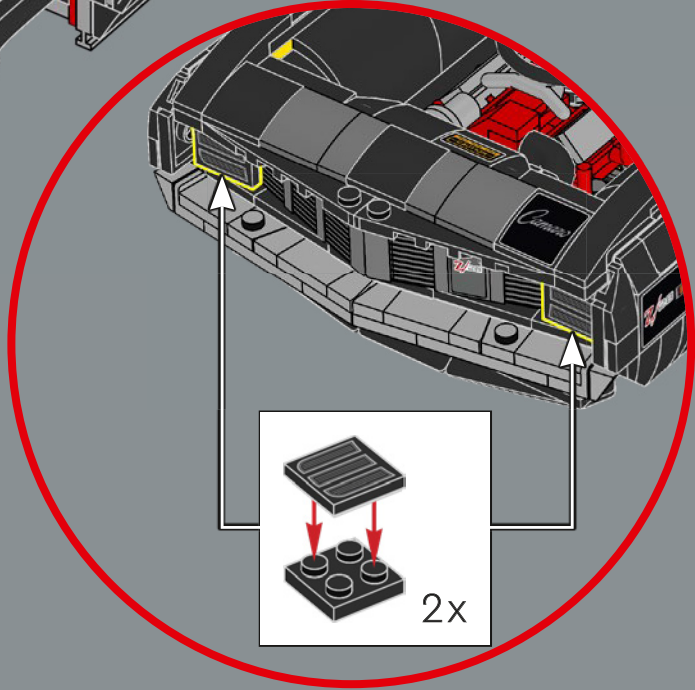
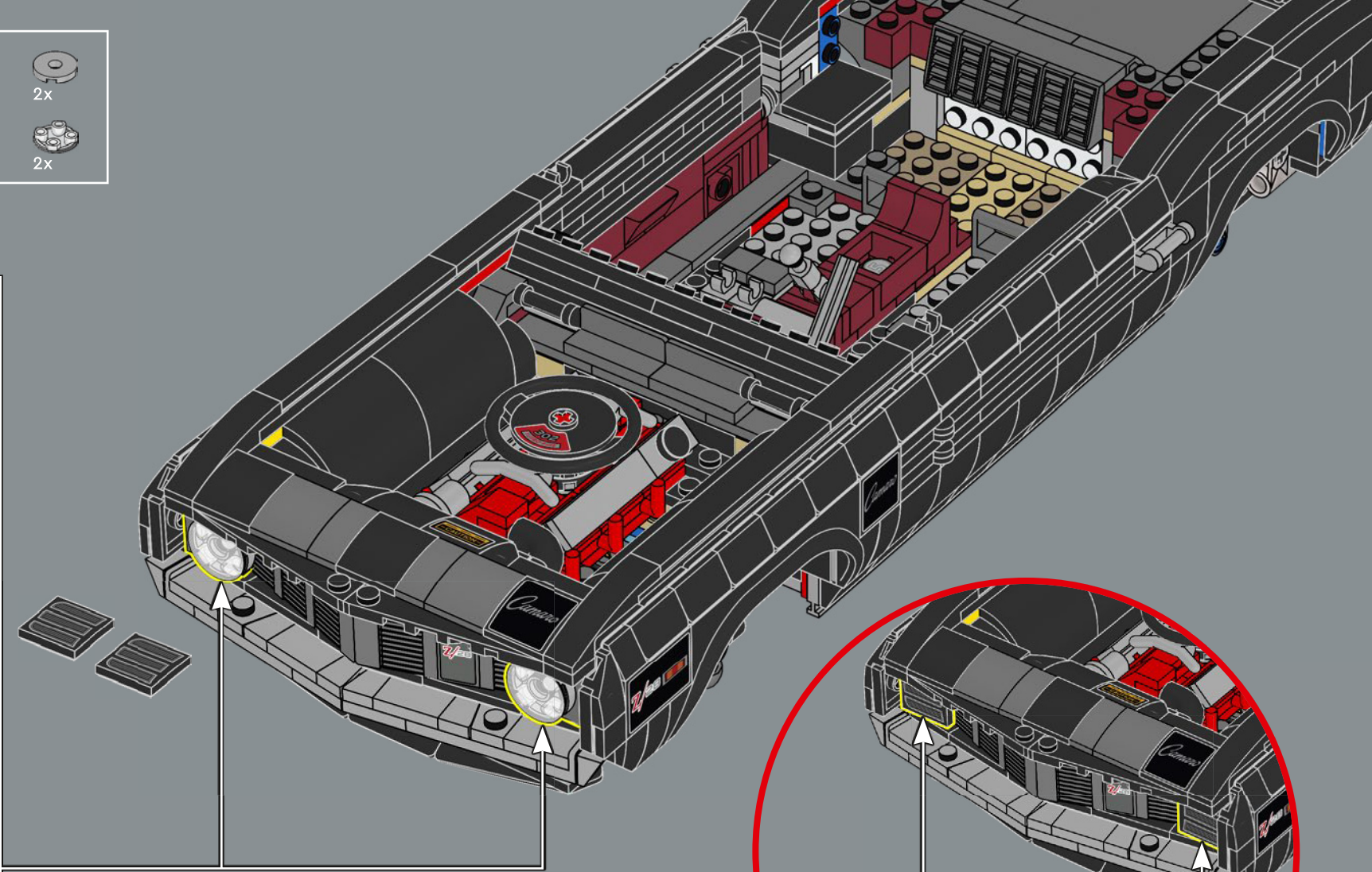
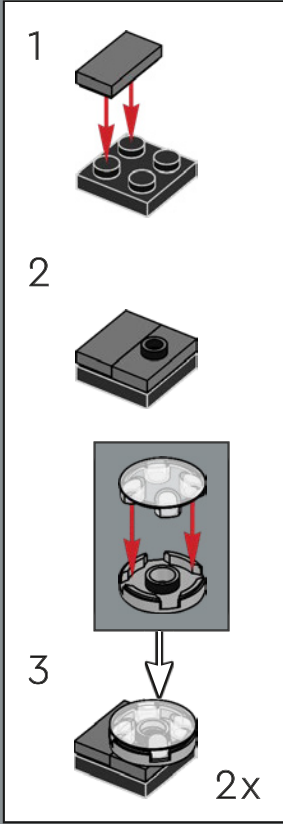

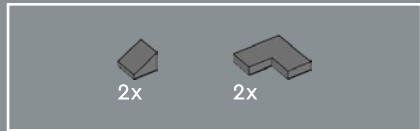

257

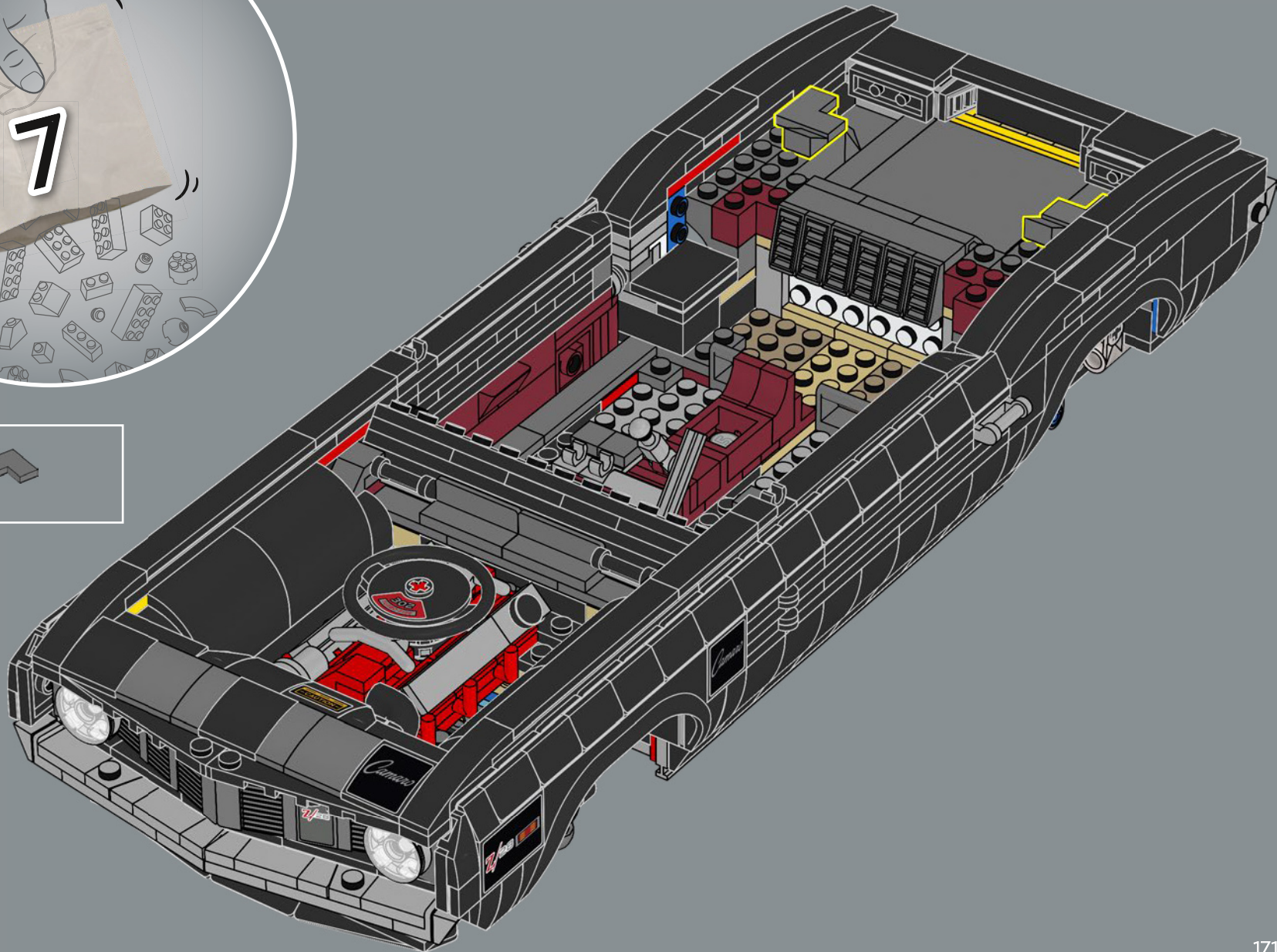

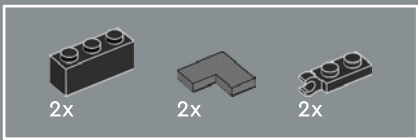

258

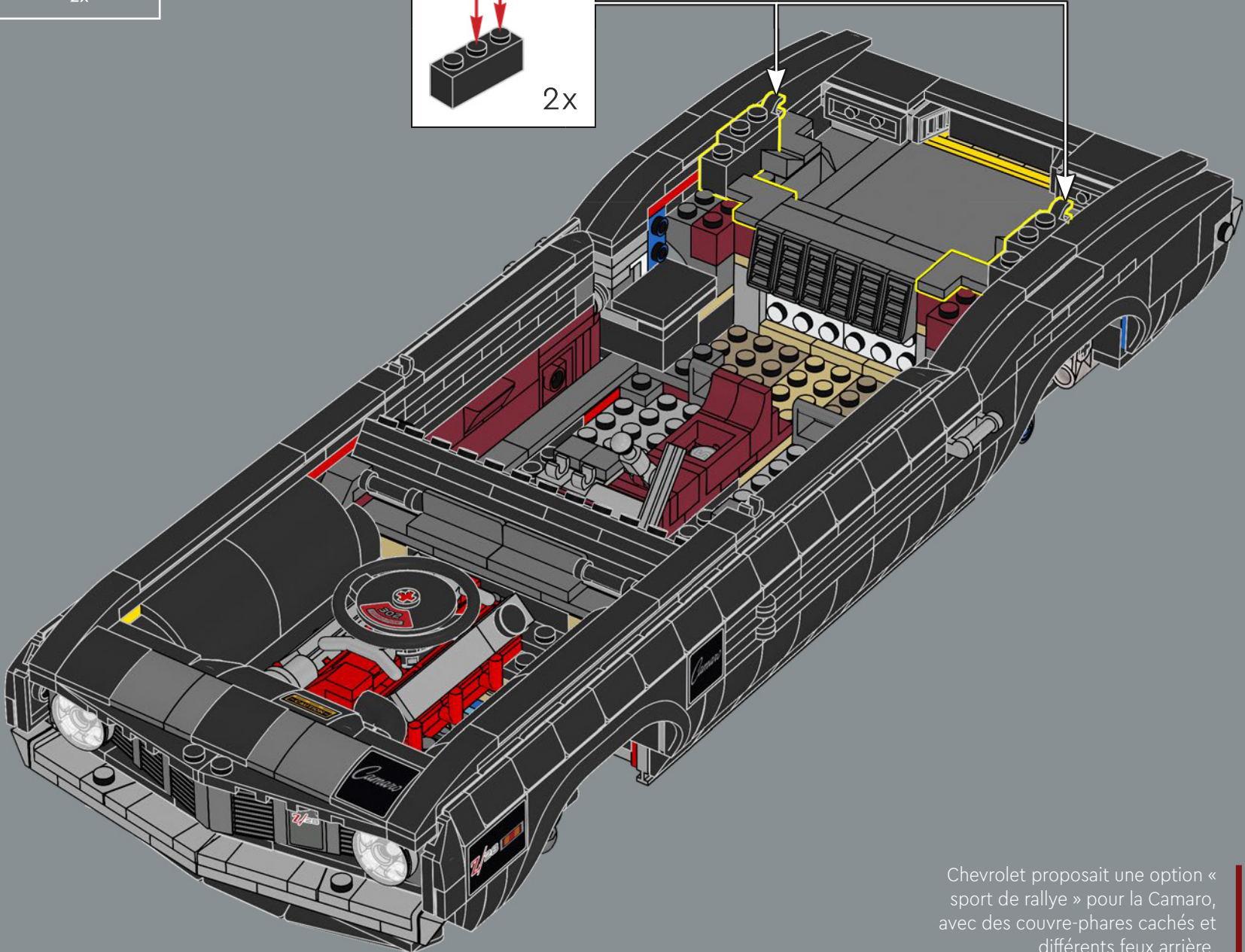
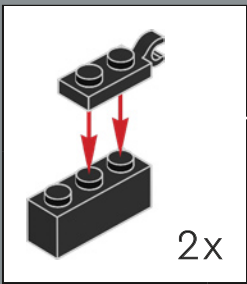

Chevrolet proposait une option « sport de rallye » pour la Camaro, avec des couvre-phares cachés et différents feux arrière.

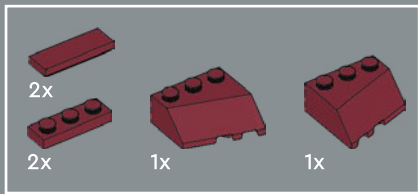

259

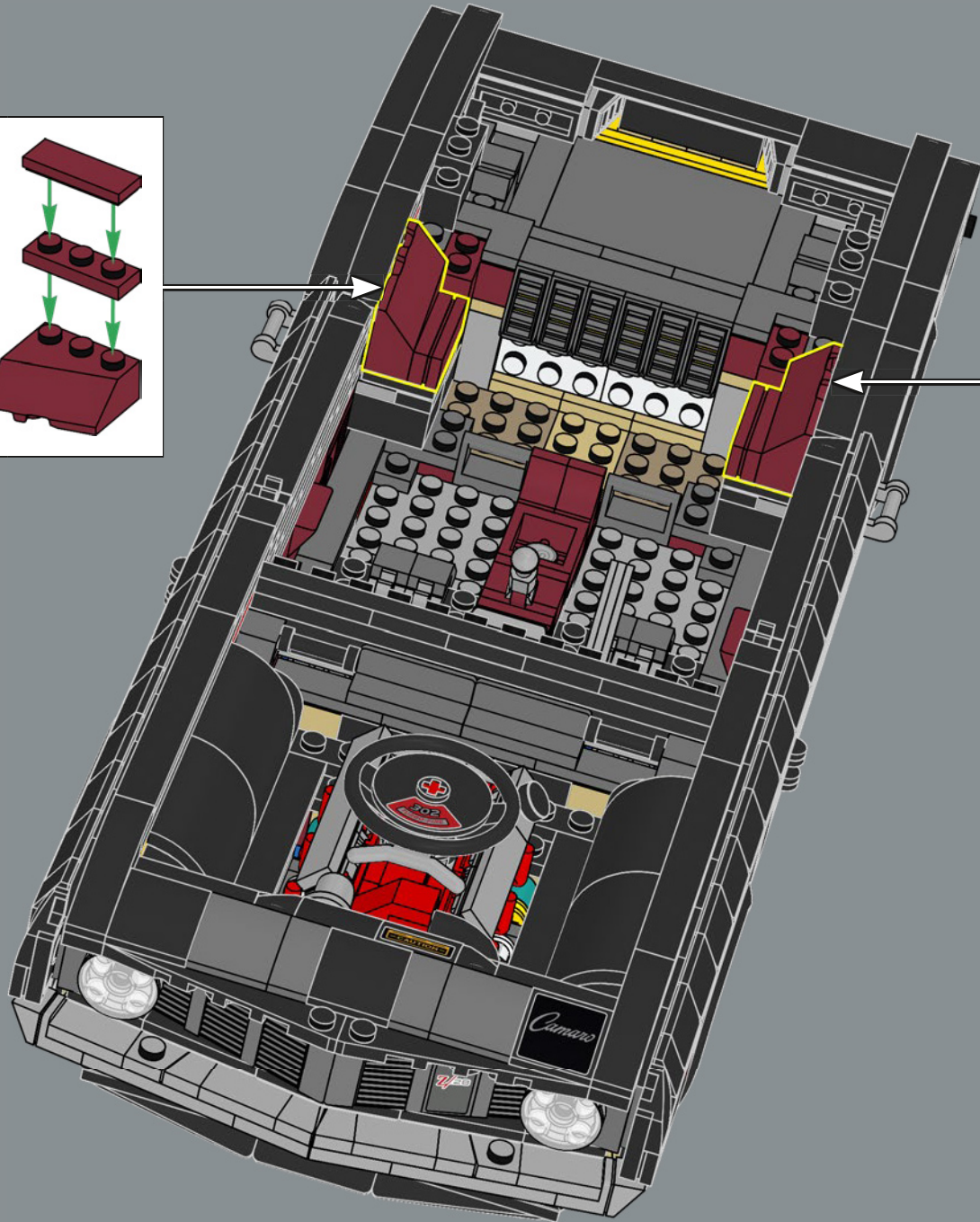
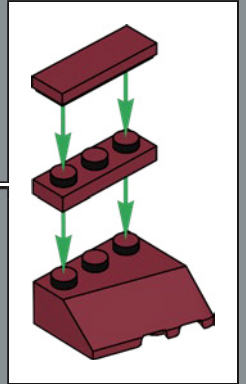
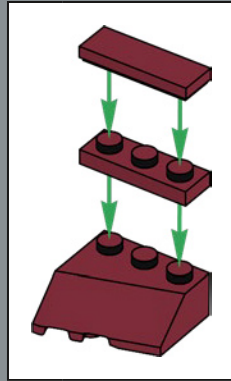

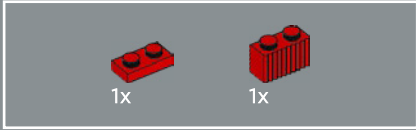

260



261

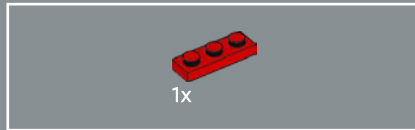
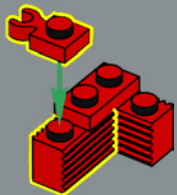

262

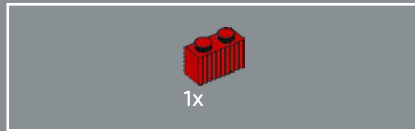
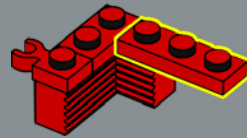

263

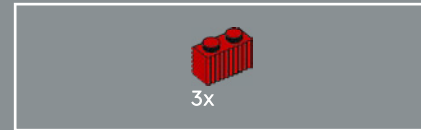
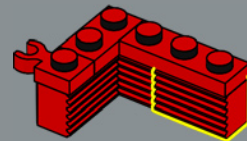

264

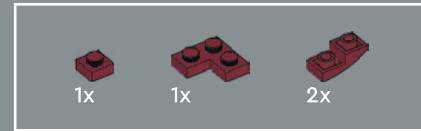
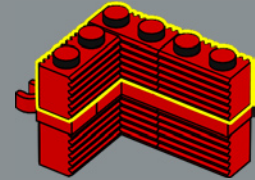

265

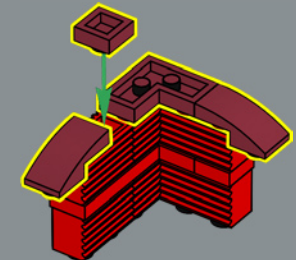

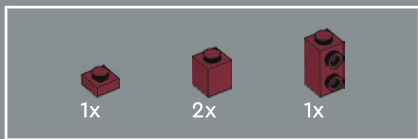

266

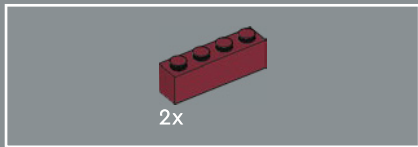
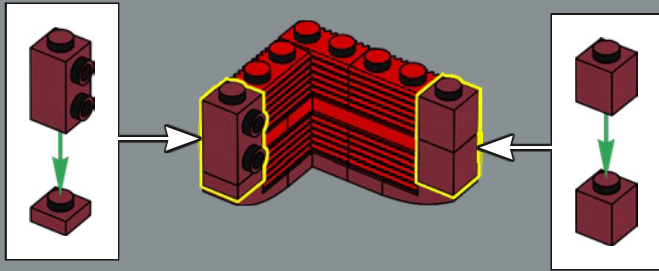

267

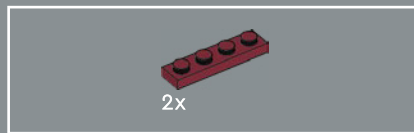
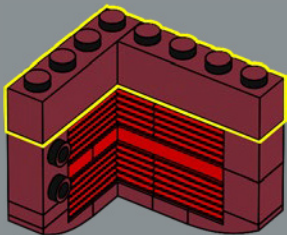

268

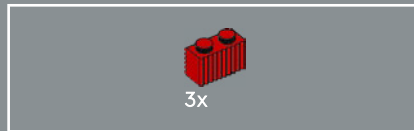
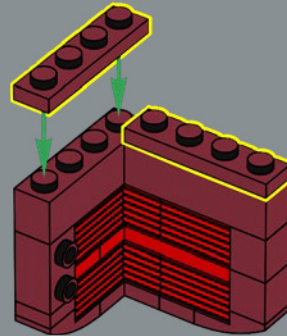

269

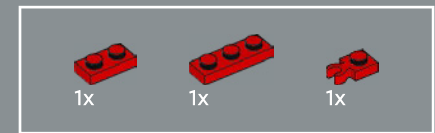
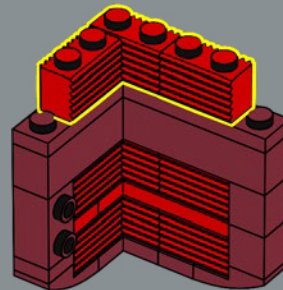

270

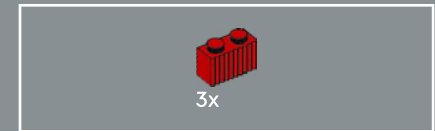
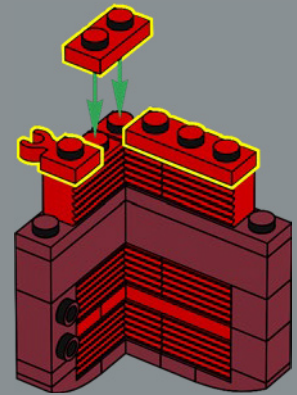

271

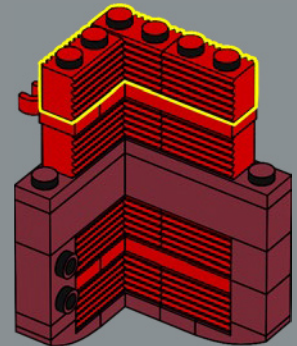



4x

272

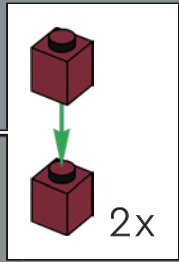
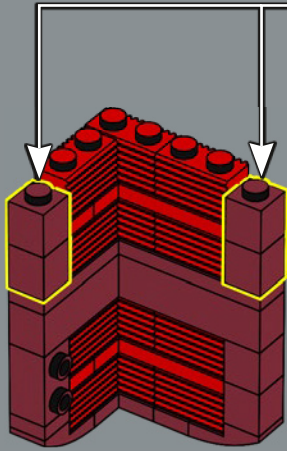

2x

1x

2x

1x

273

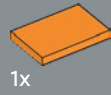
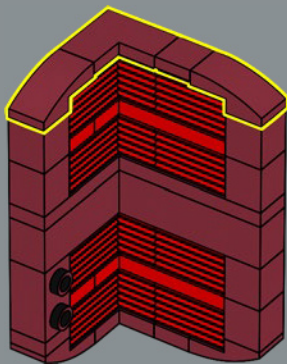

1x

274



15

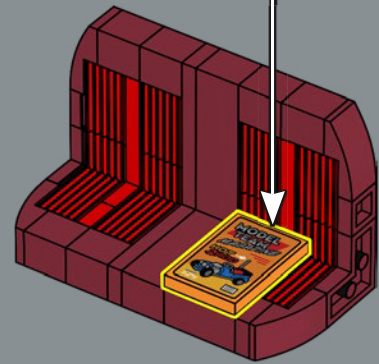

275

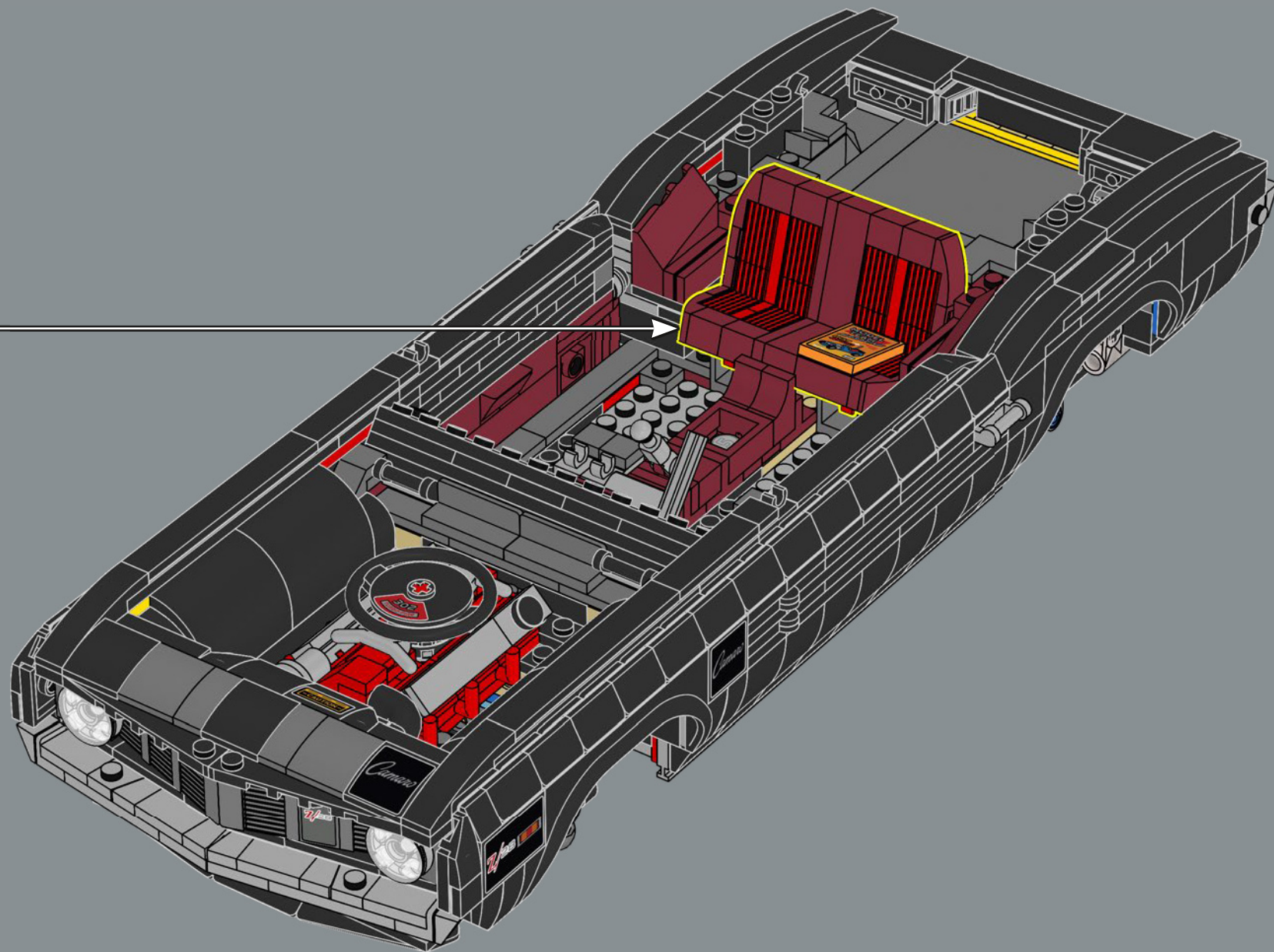

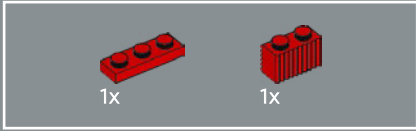

276

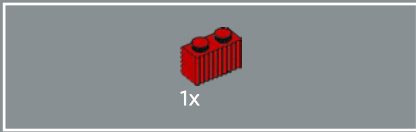
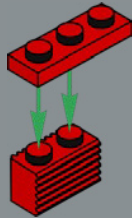

277

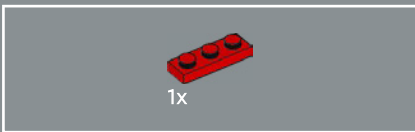
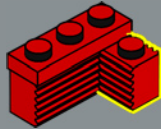

278

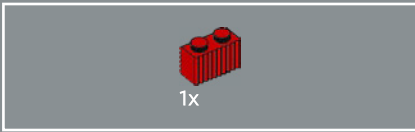
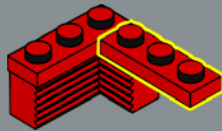

279

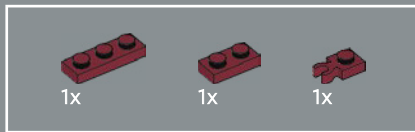
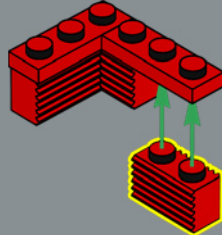

280

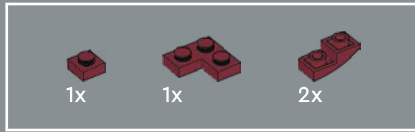
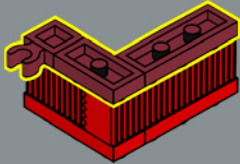

281

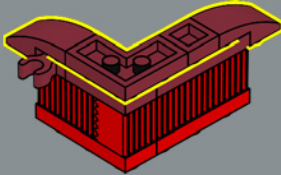



282

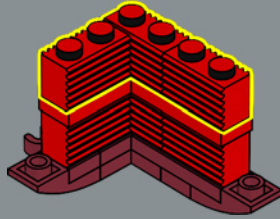

283

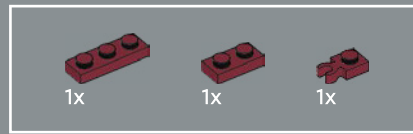
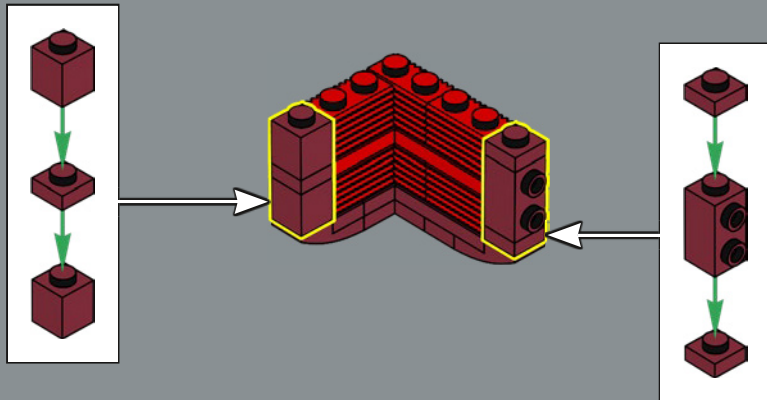

284

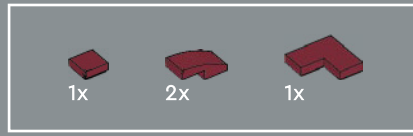
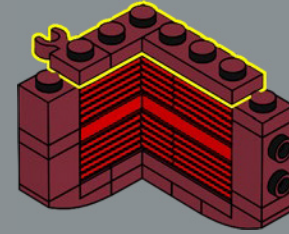

285

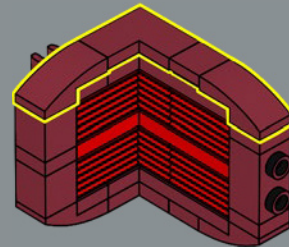



1x

286

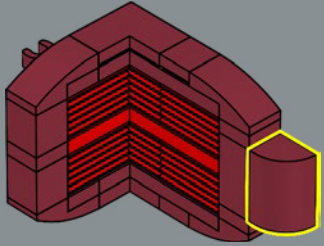

1x

287

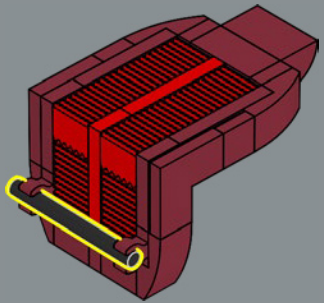

288

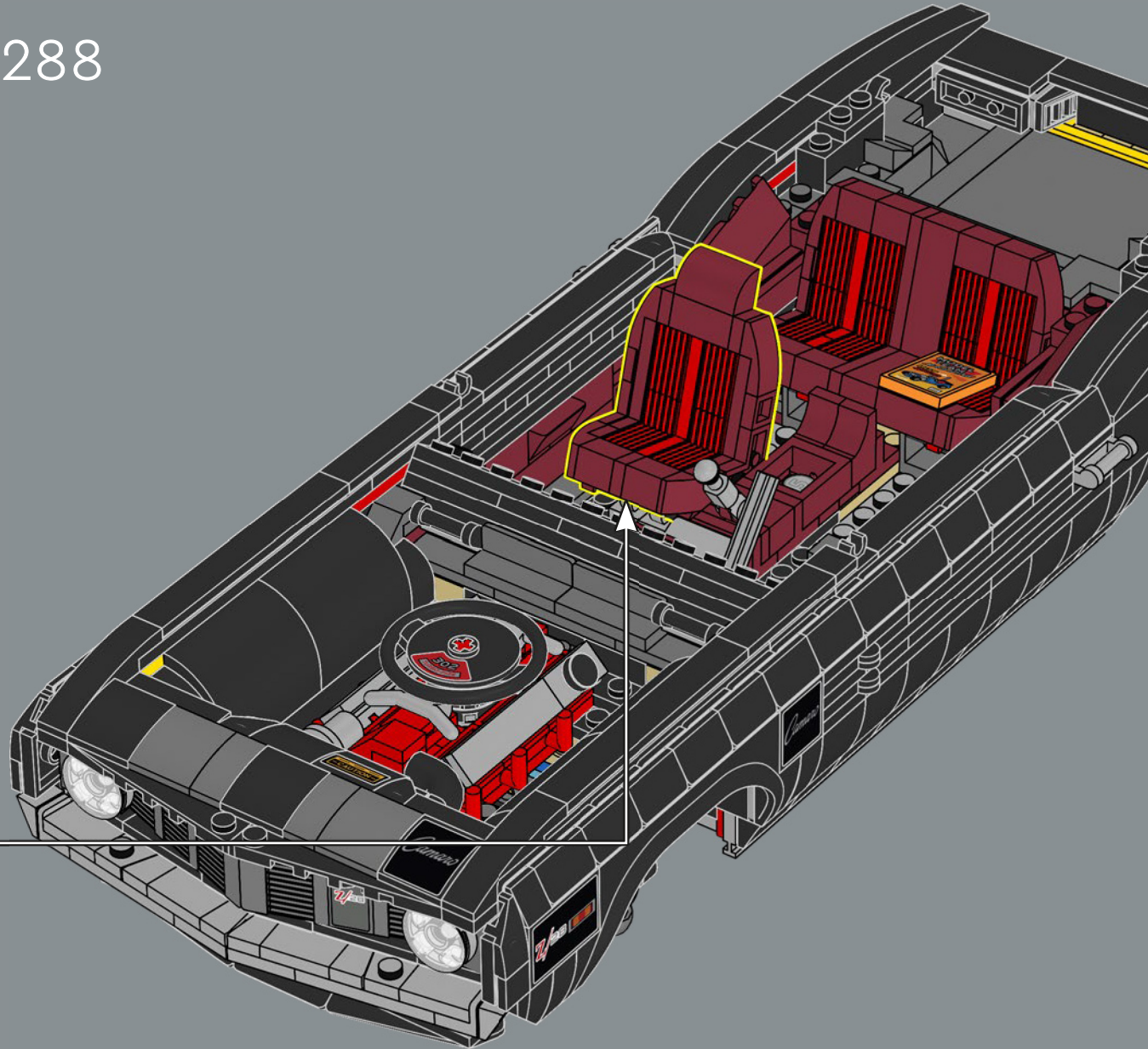

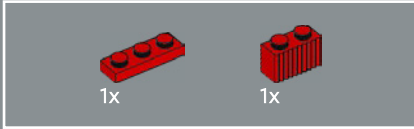
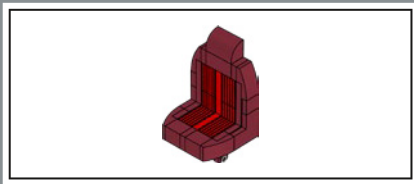

289

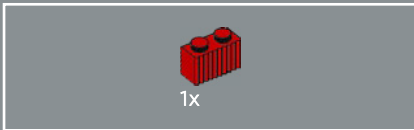
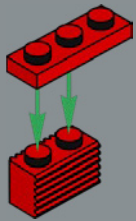

290

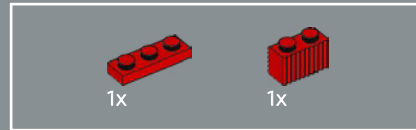
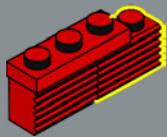

291

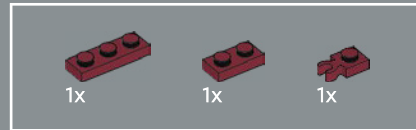
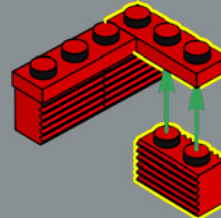

292

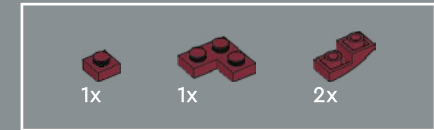
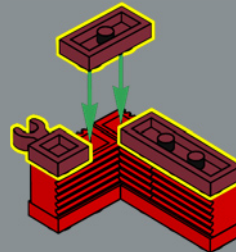

293

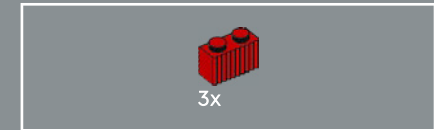
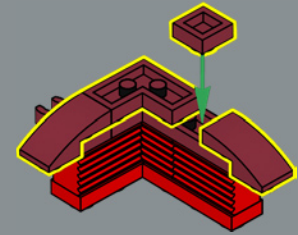

294

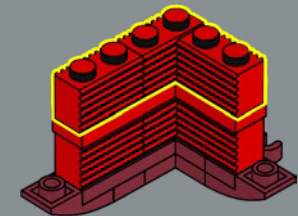



295

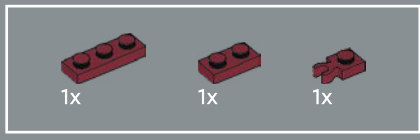
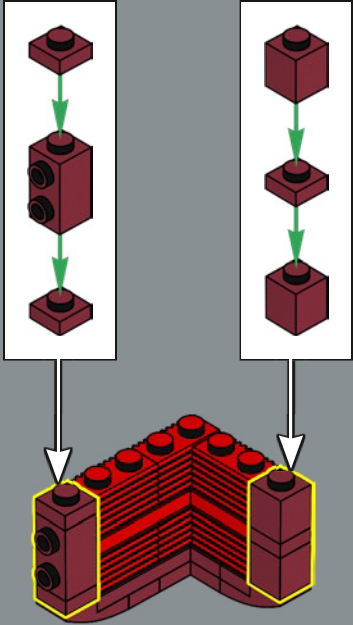

296

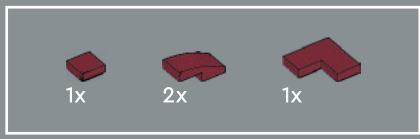
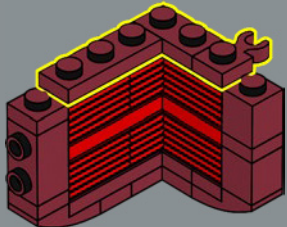

297

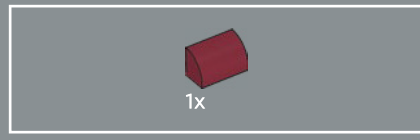
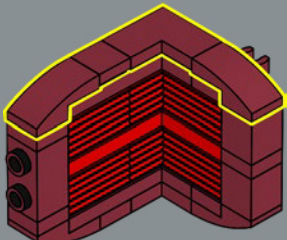

298

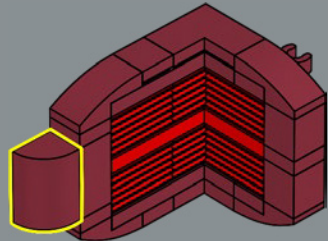

299

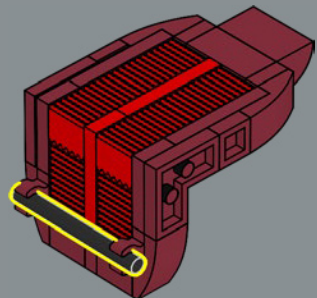

300

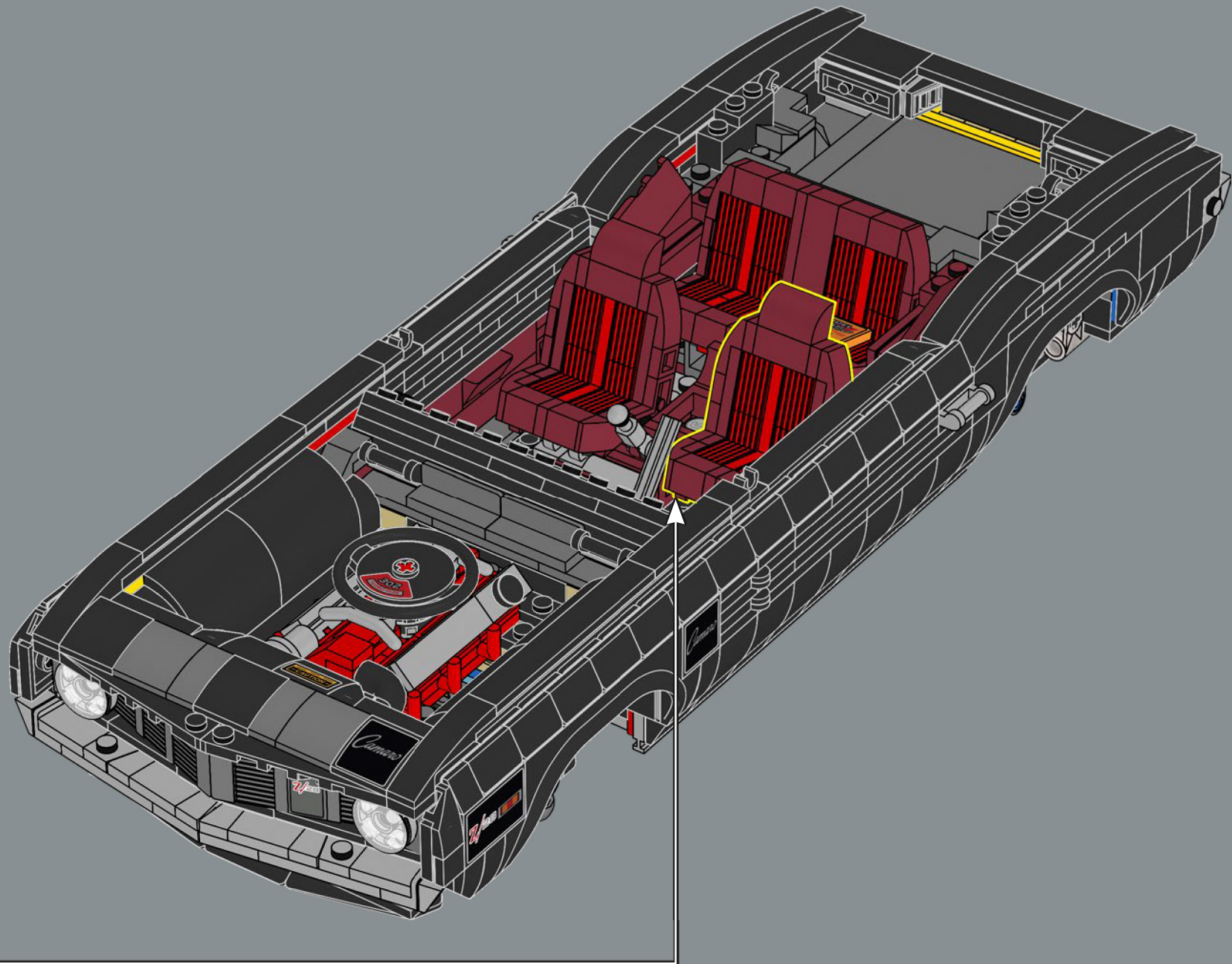

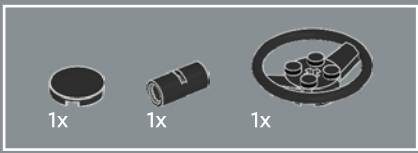

301

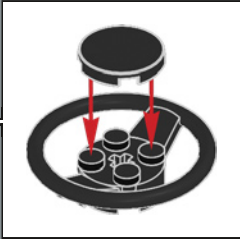
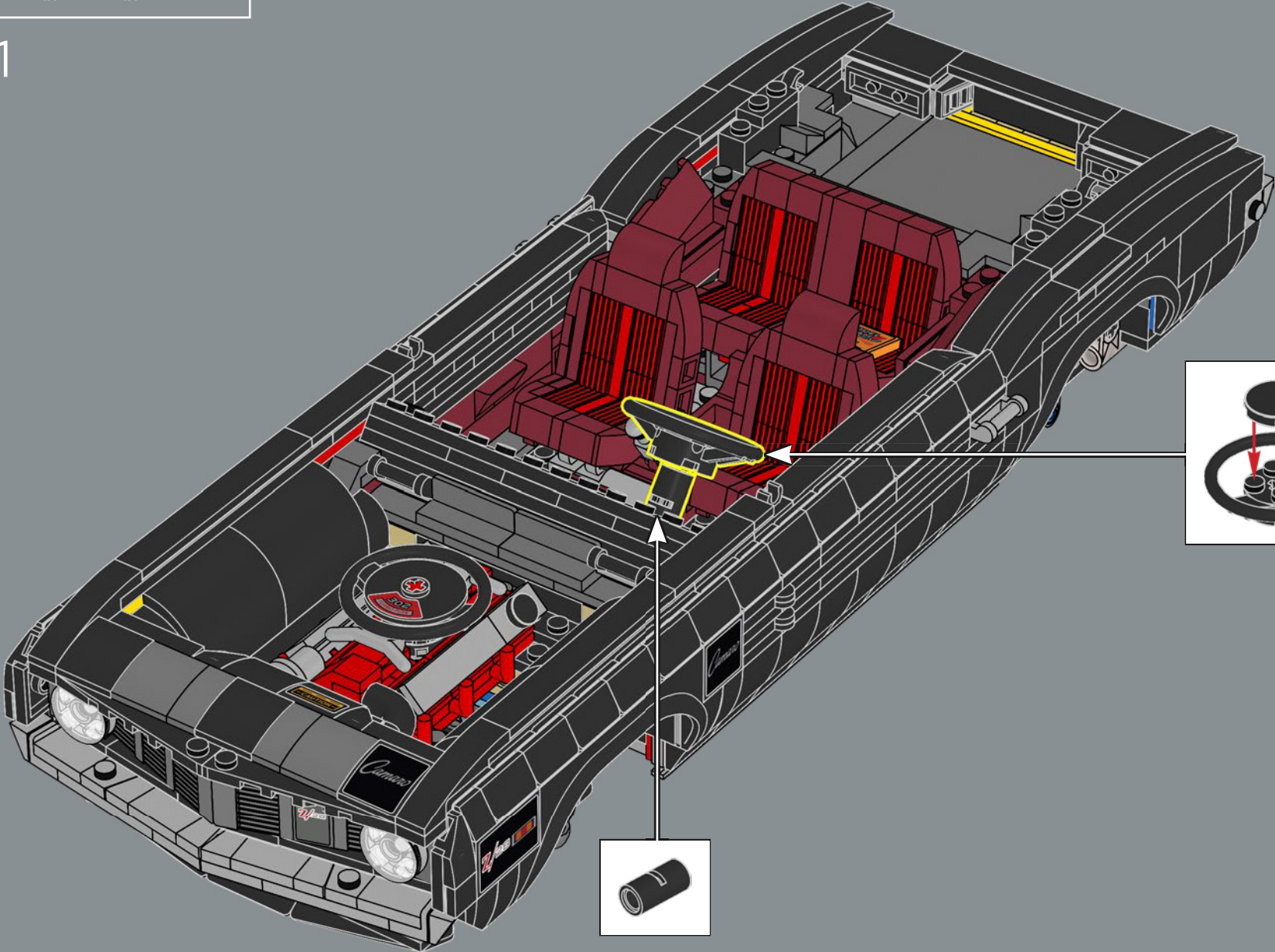

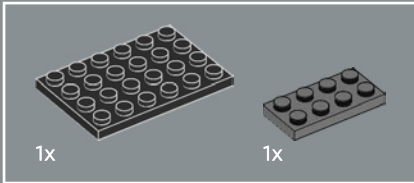
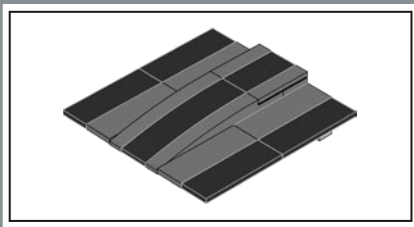

302

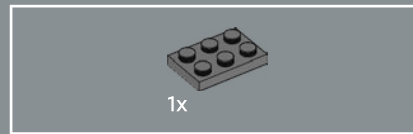
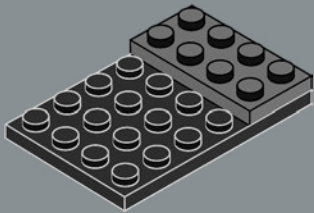

303

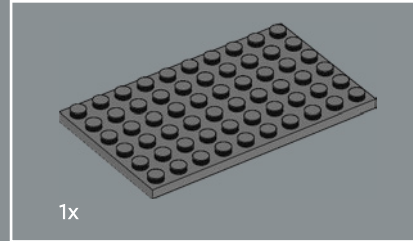
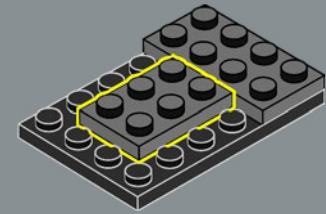

304

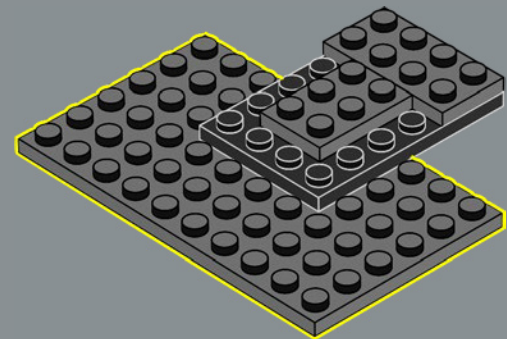

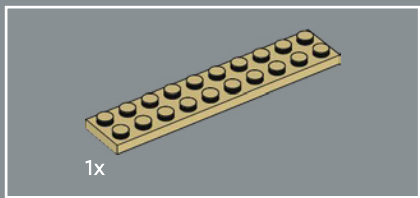

305

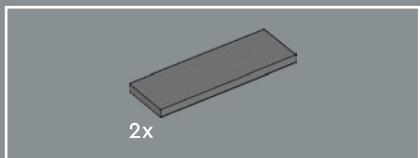
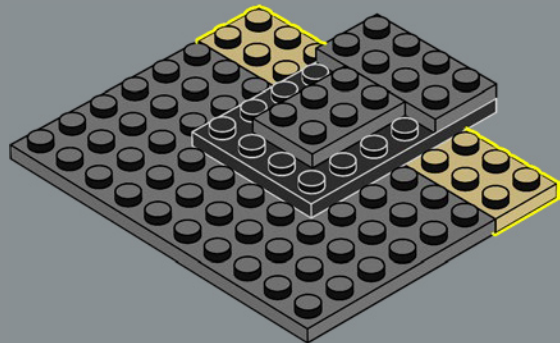

306

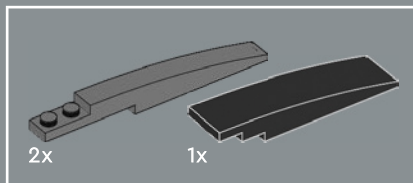
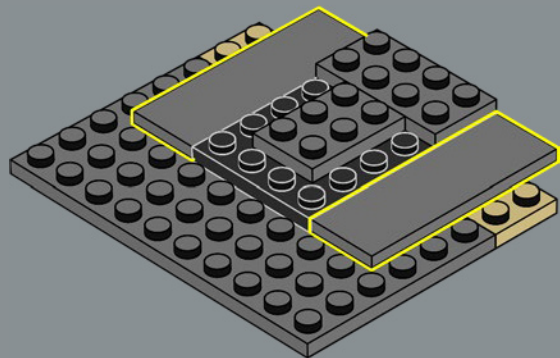

307

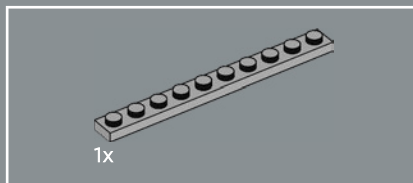
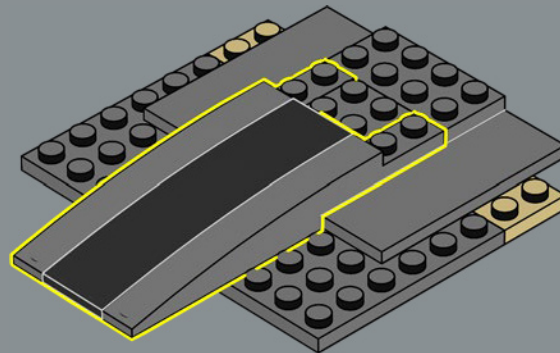

308

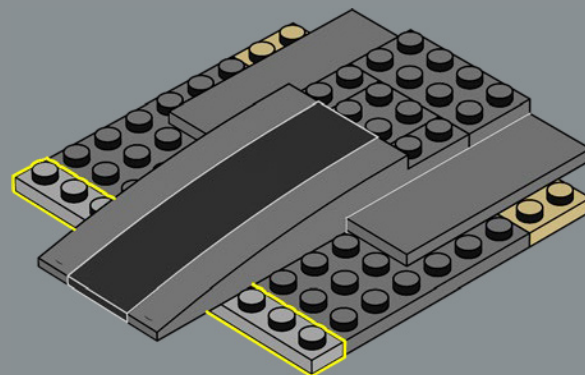

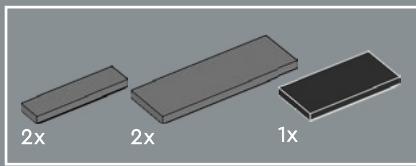

309

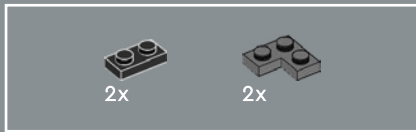
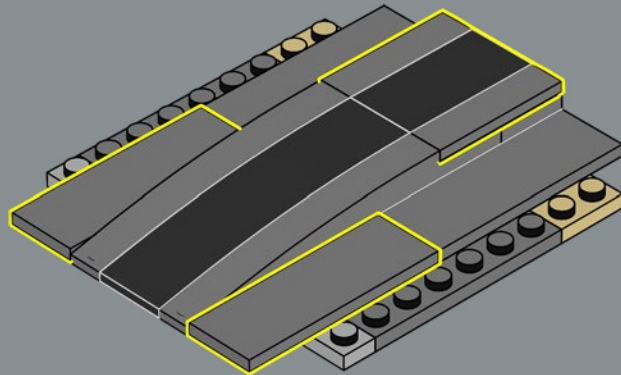

310

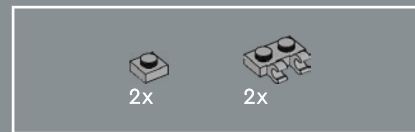
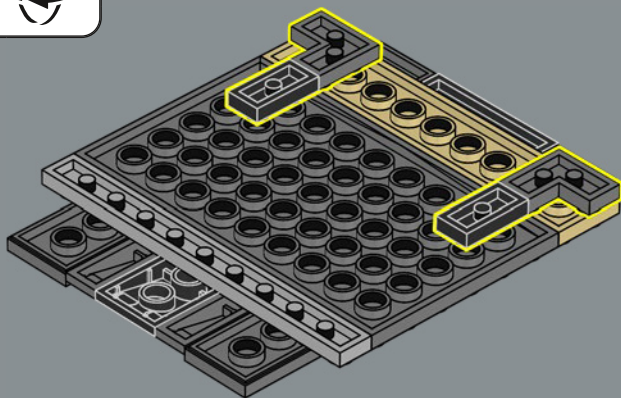

311

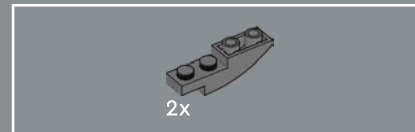
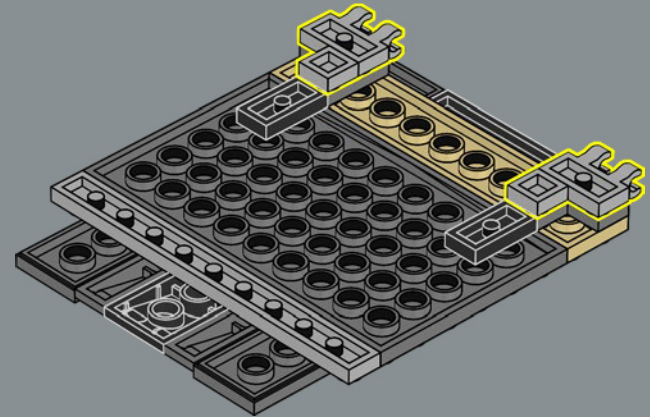

312

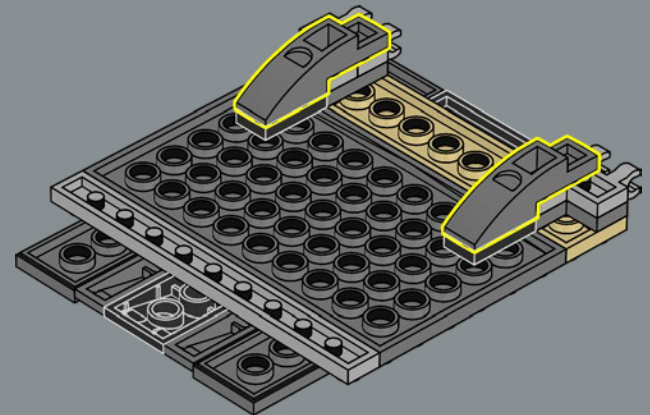

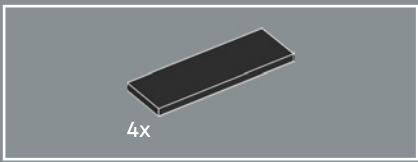

313

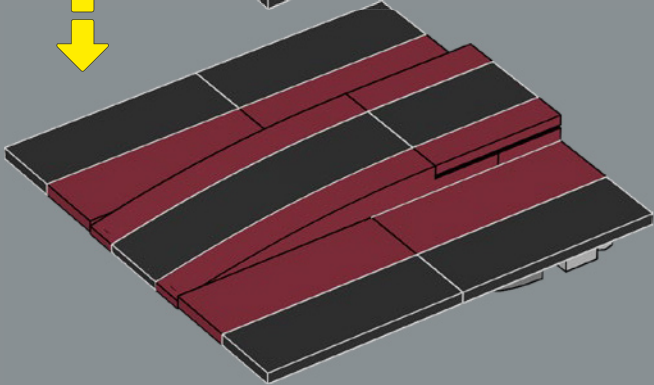
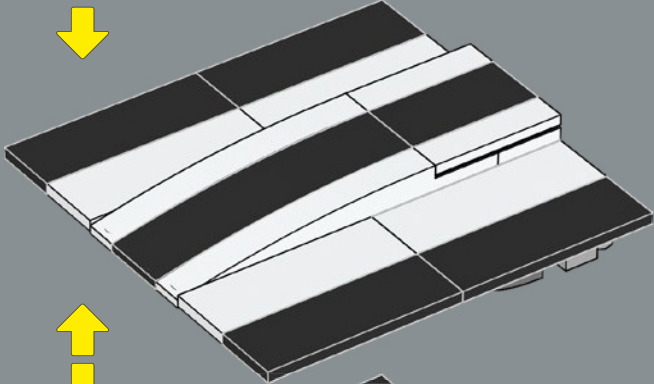
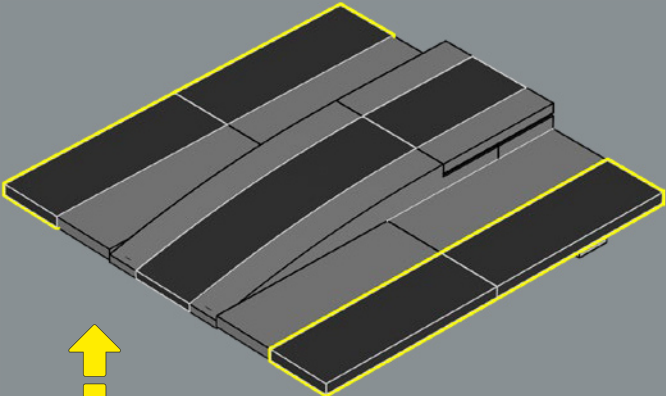

314

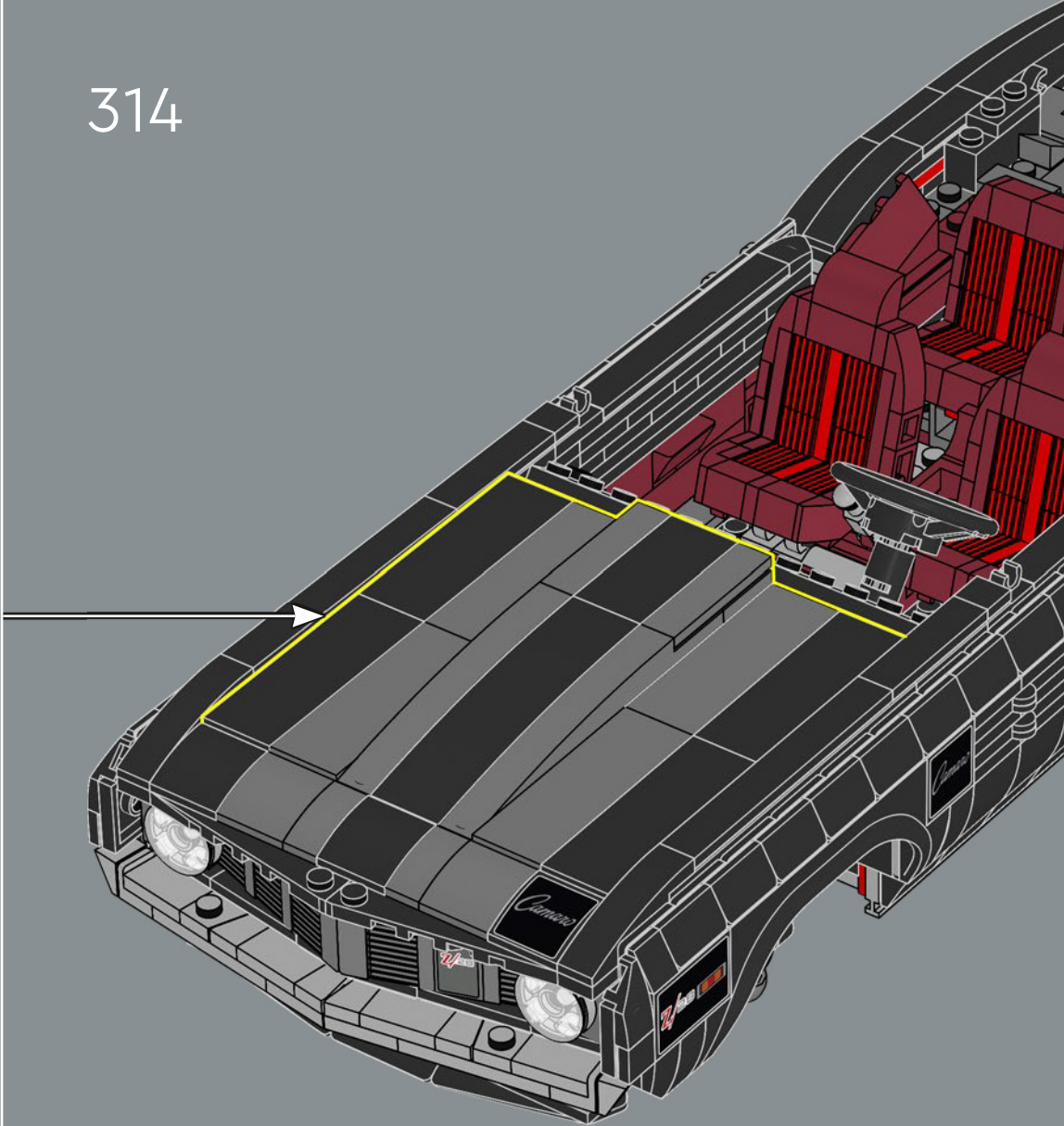

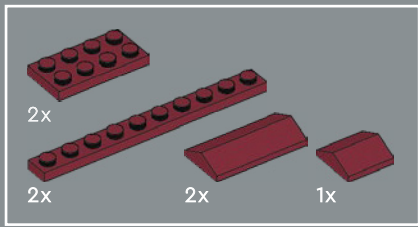

315

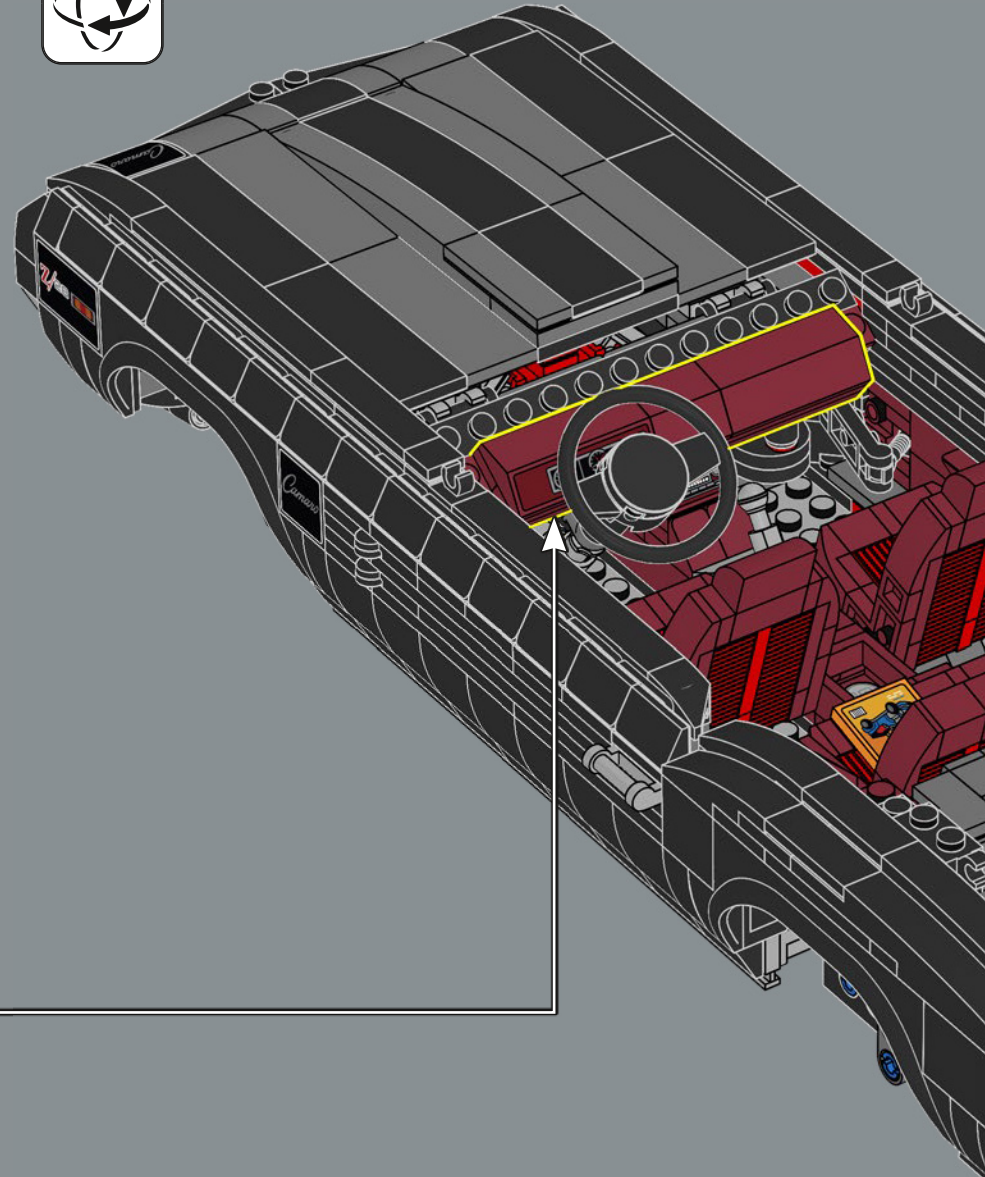
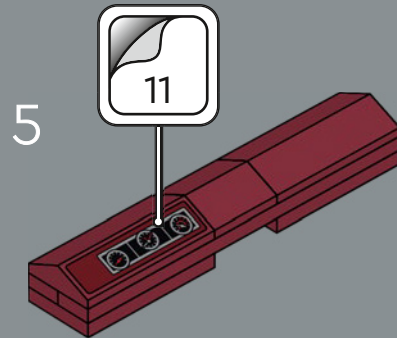
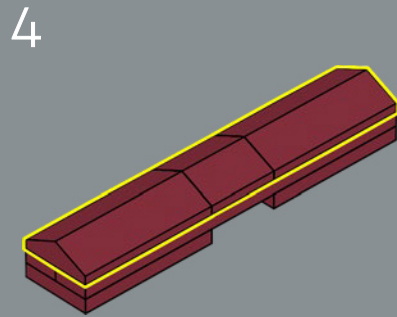
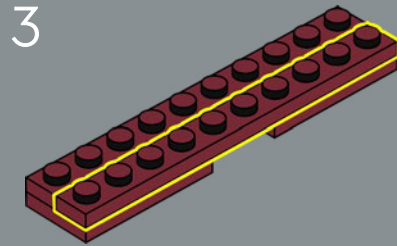
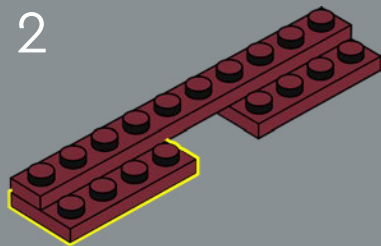
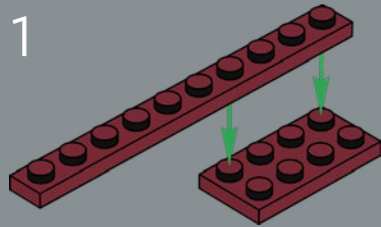

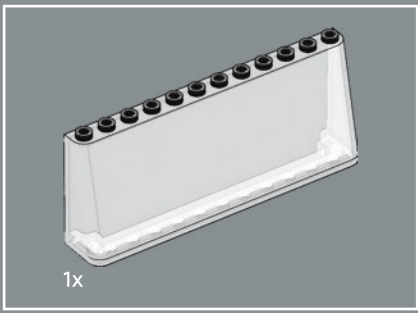

316

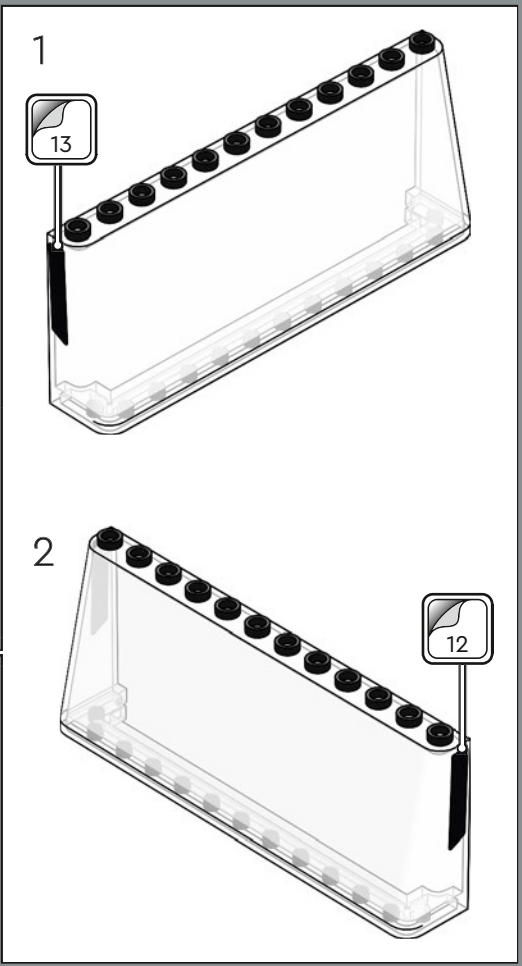
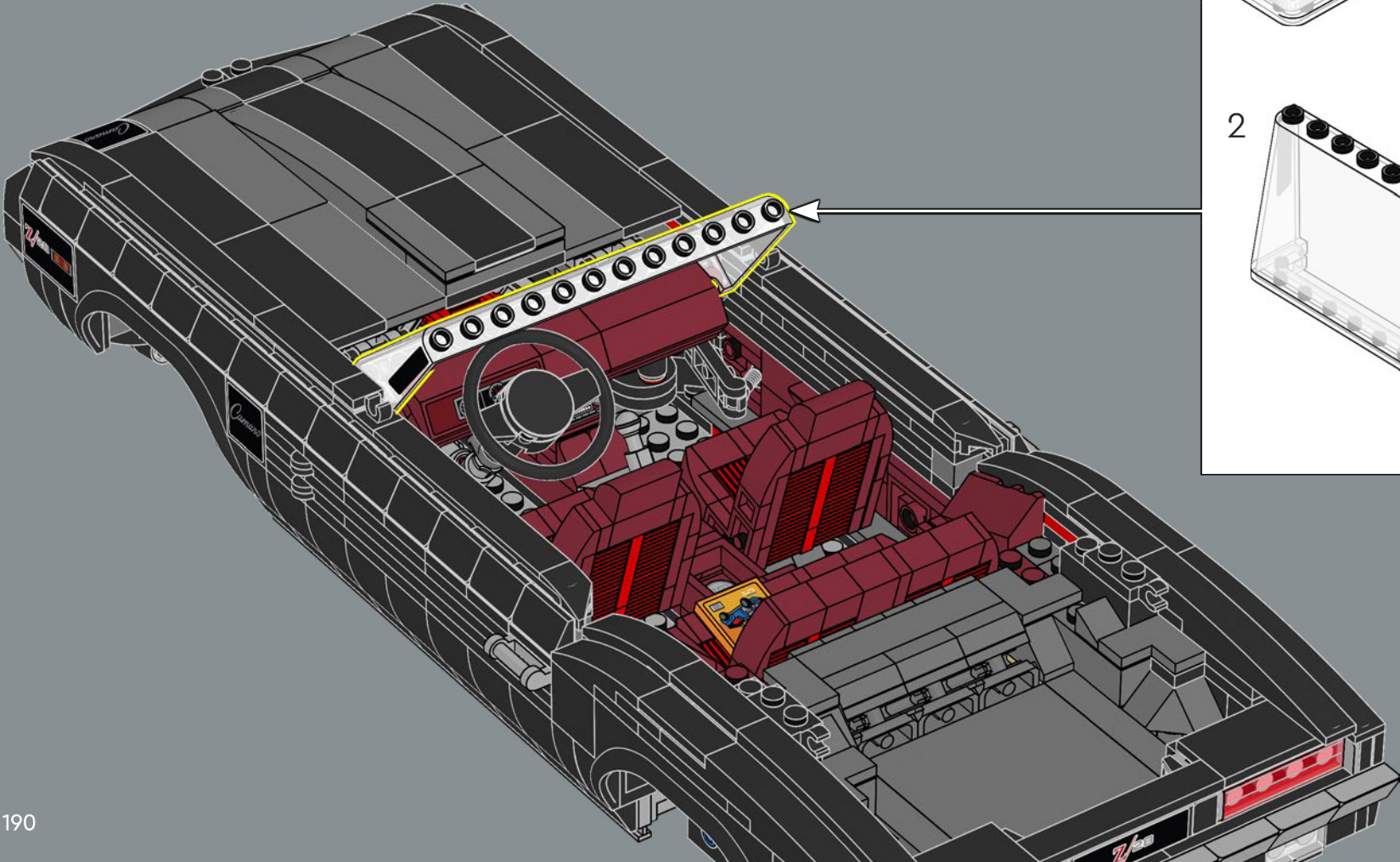

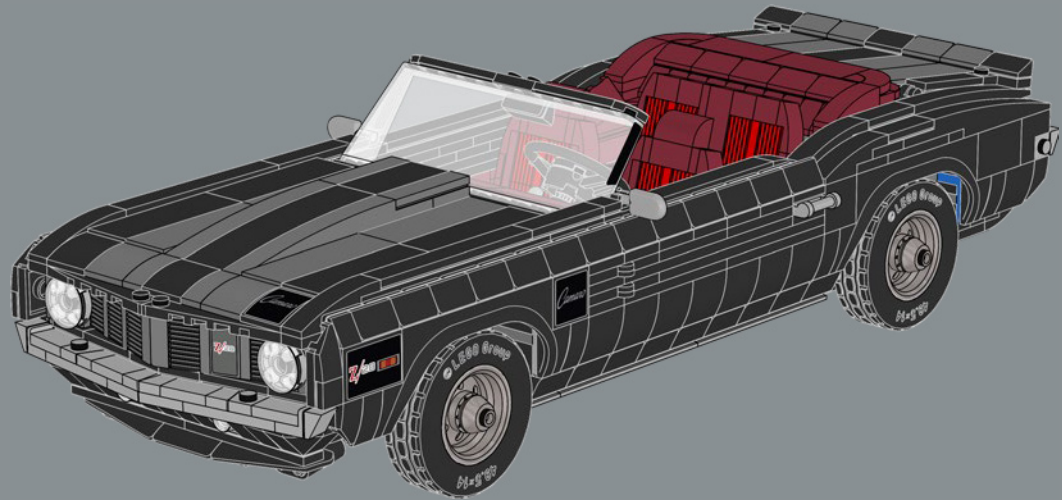
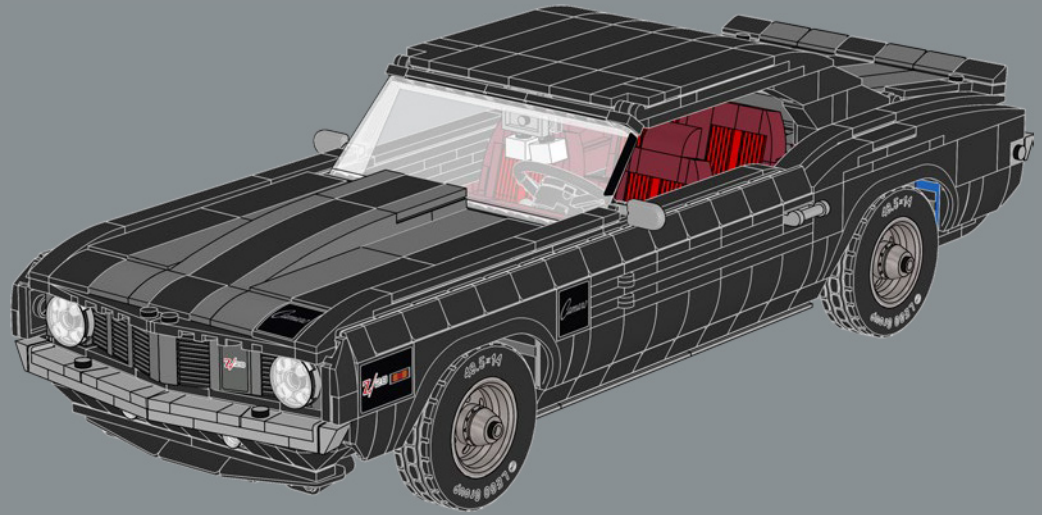

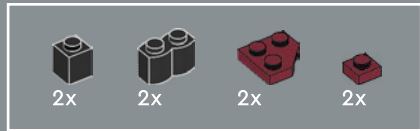
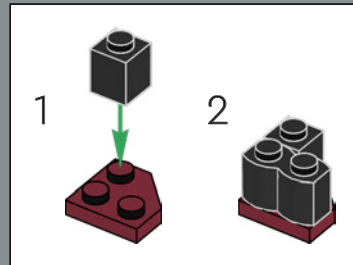

317

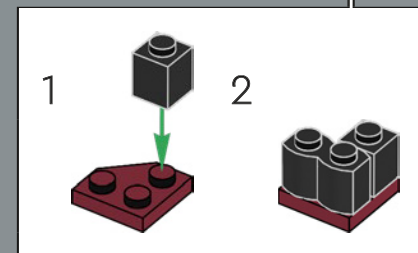
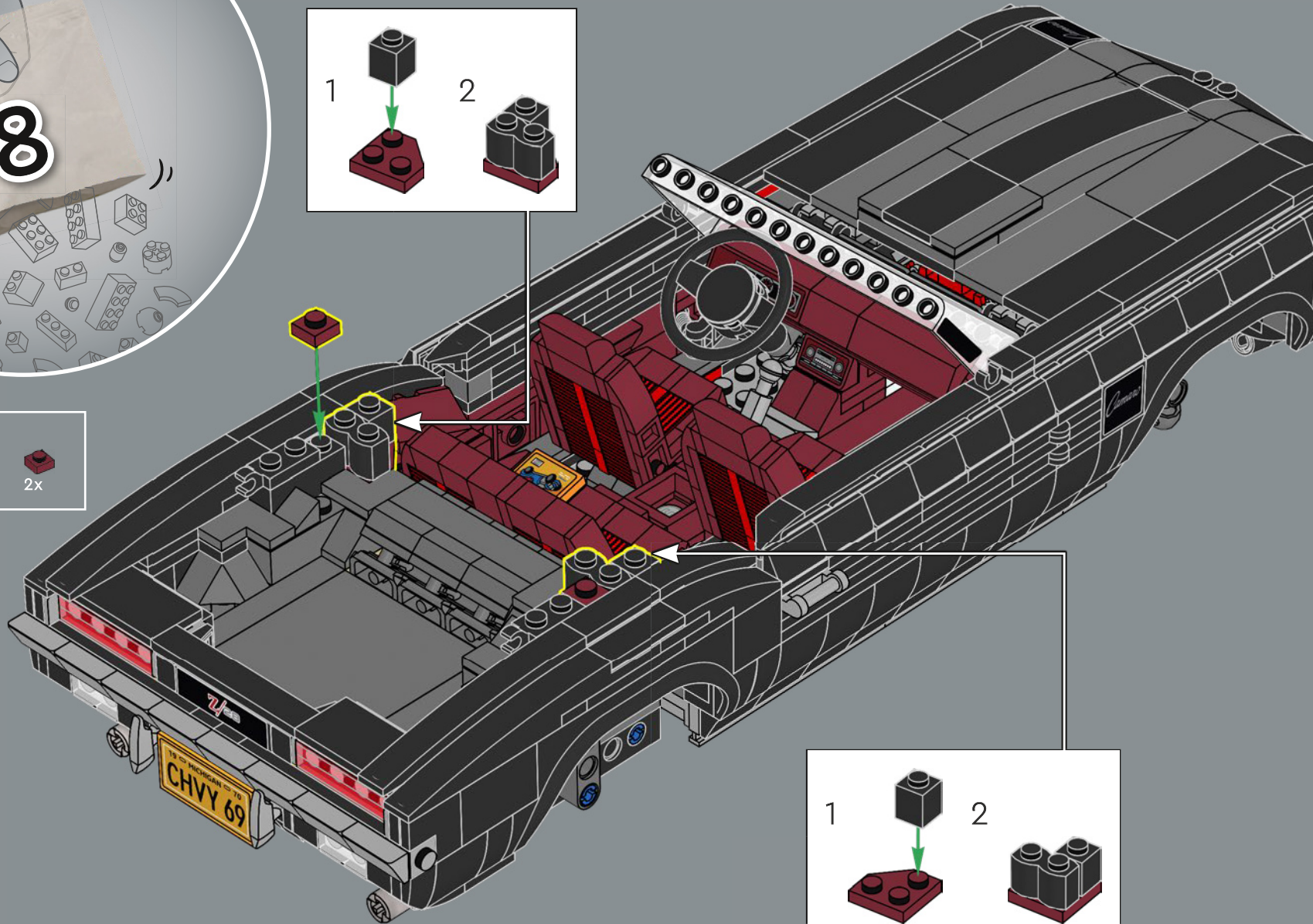

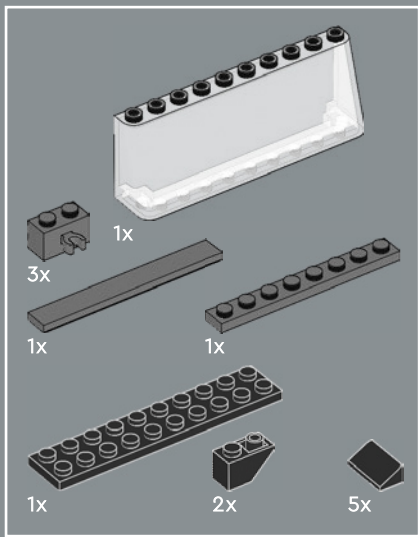

318

1

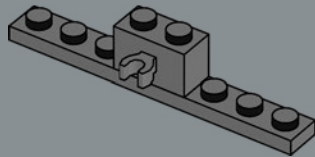

2

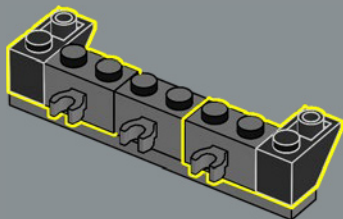

3

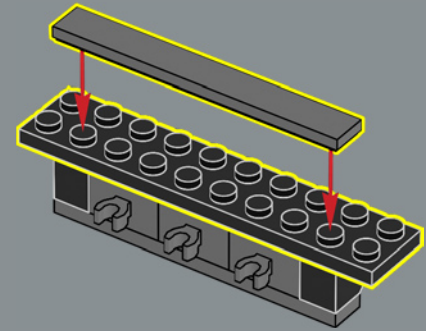

4

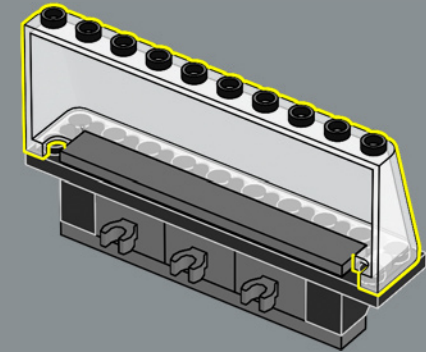

5

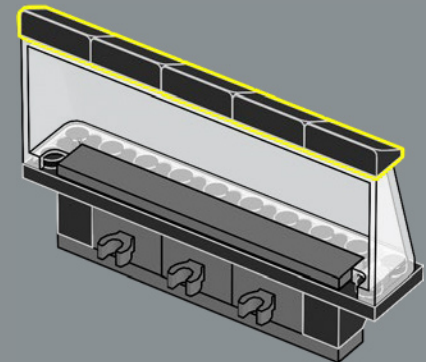

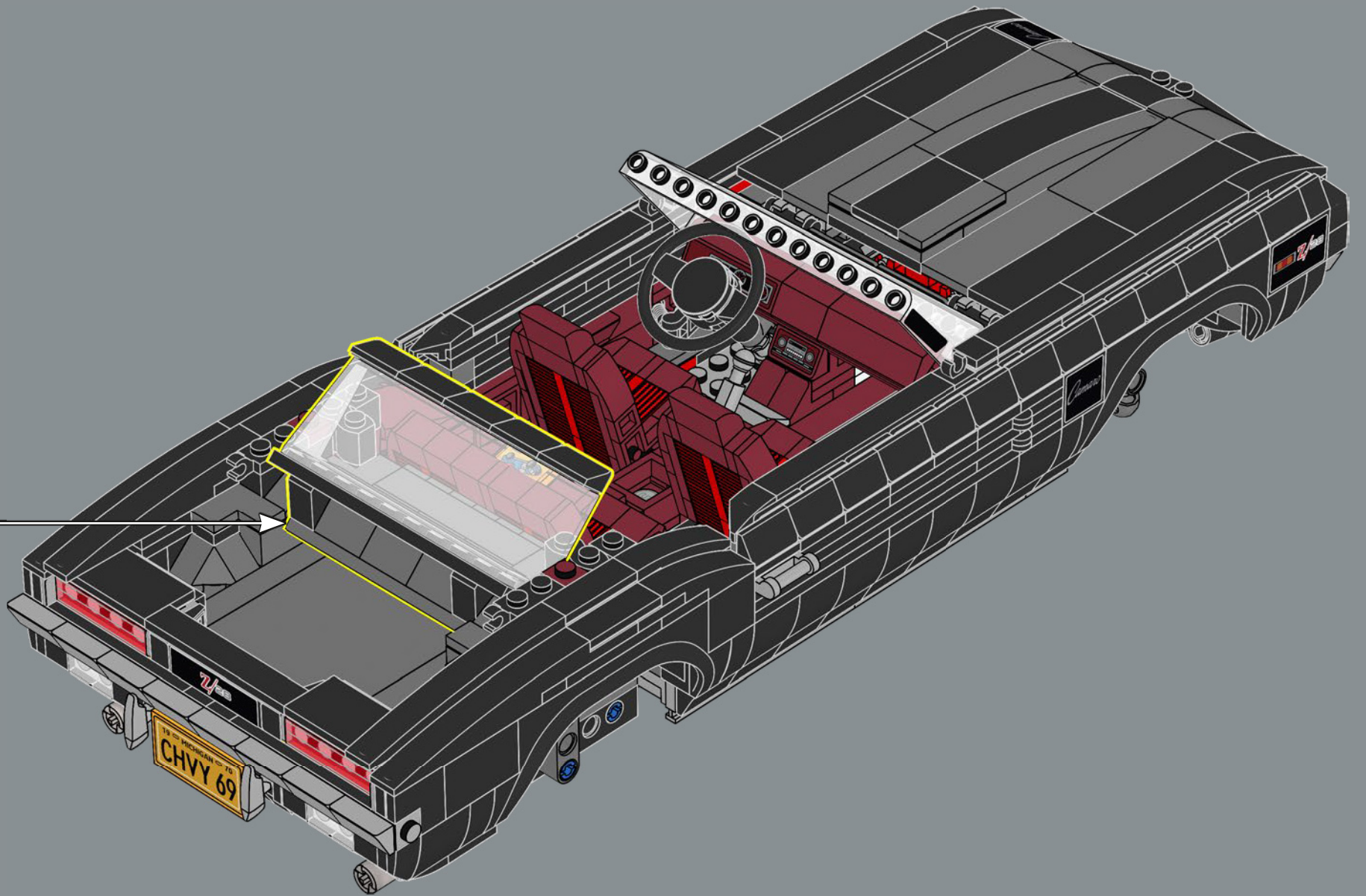

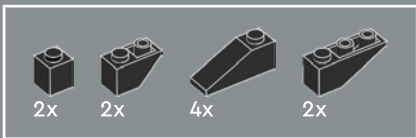

319

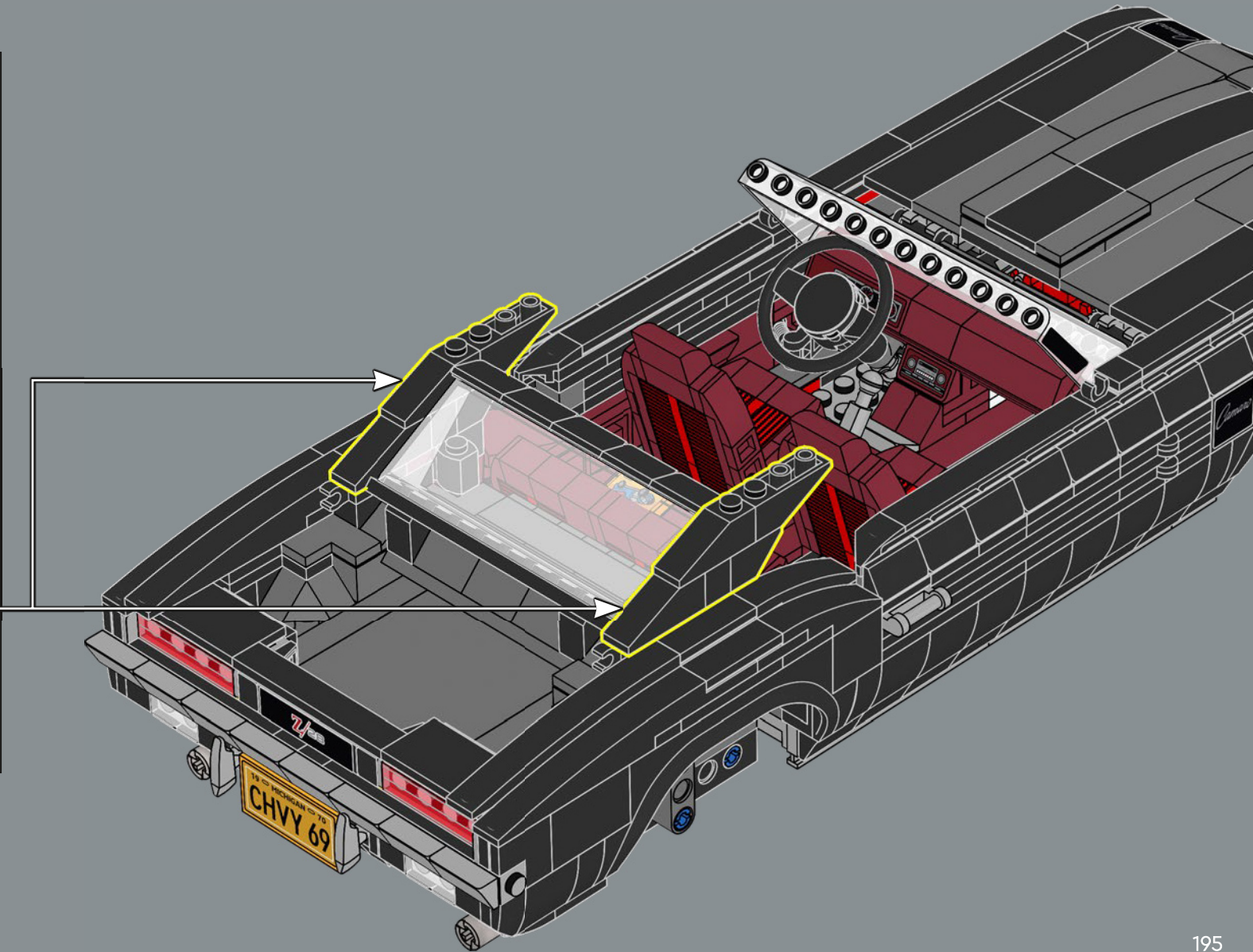
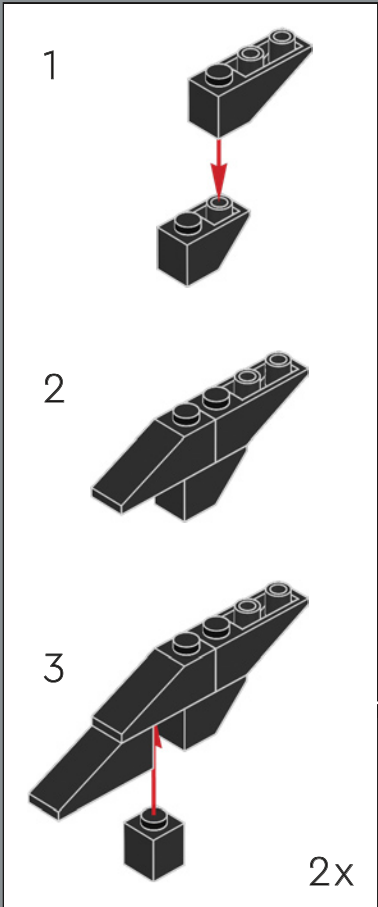

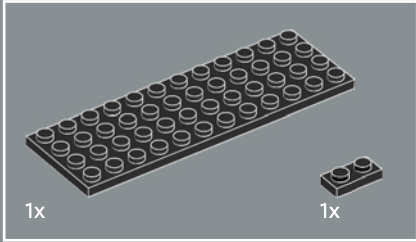
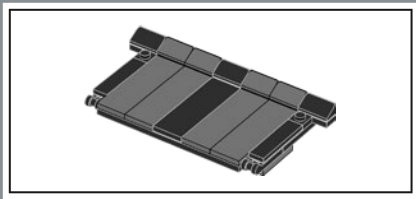

320

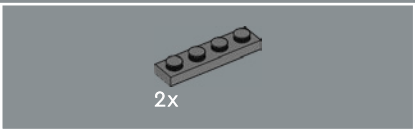
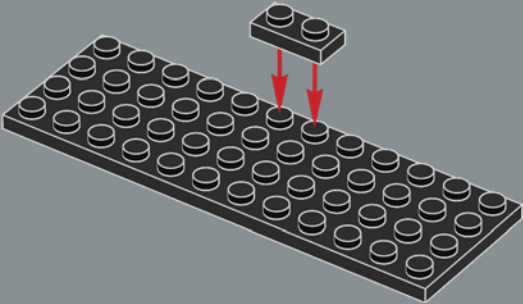

321

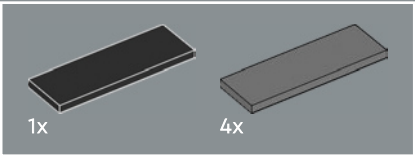
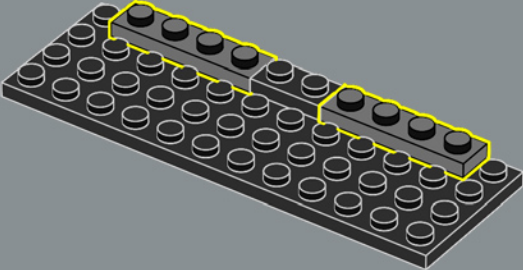

322

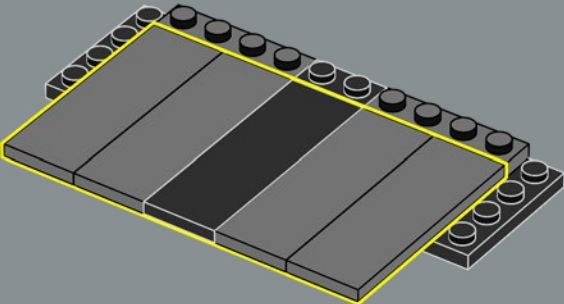

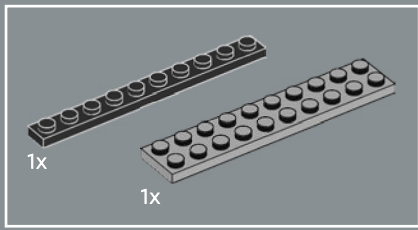

323

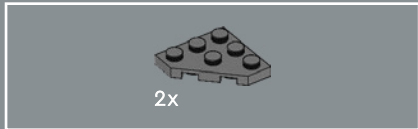
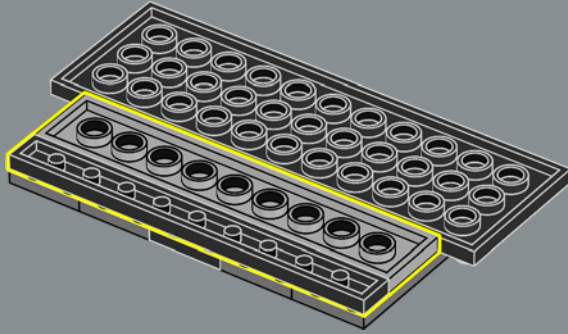

324

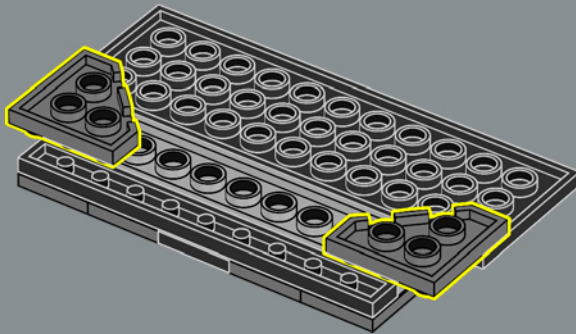

325

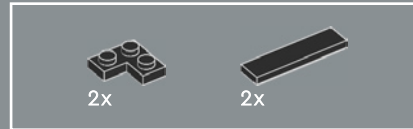
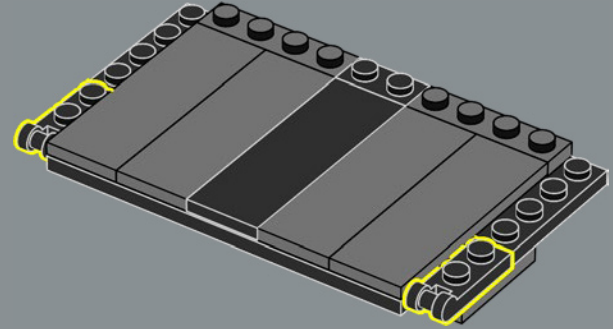

326

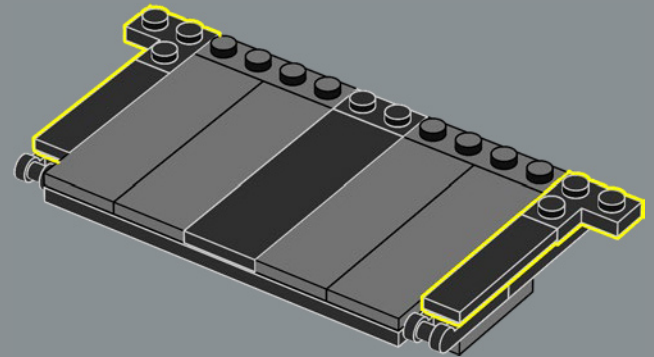



327

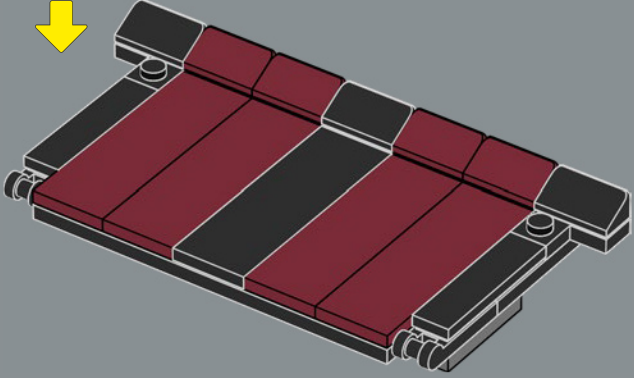
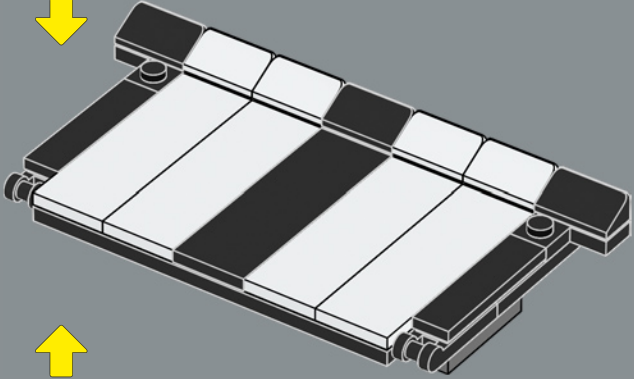
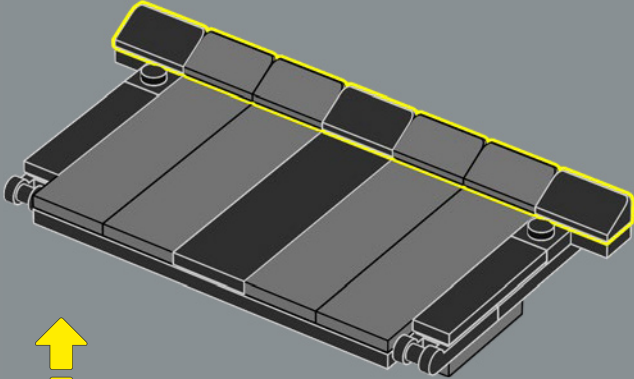

328

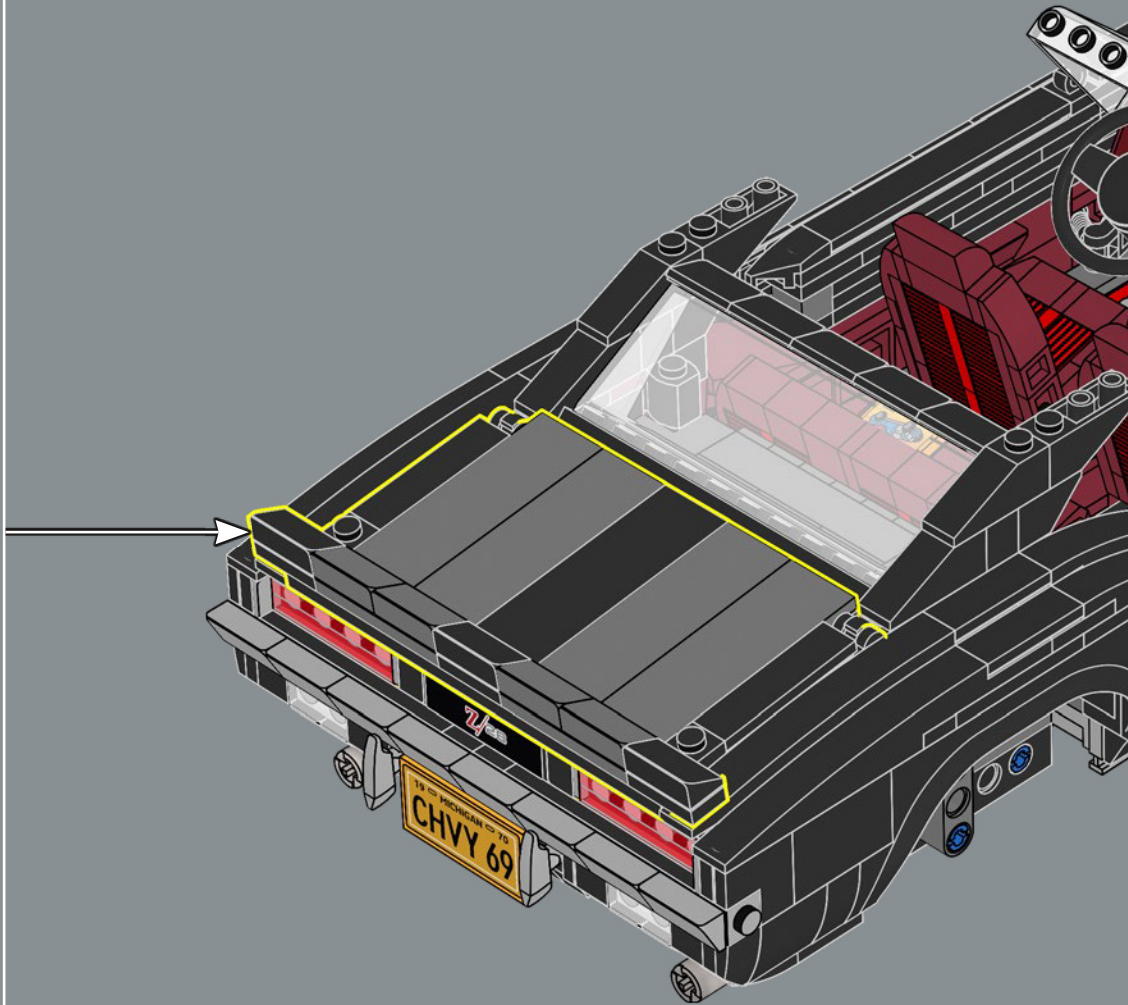

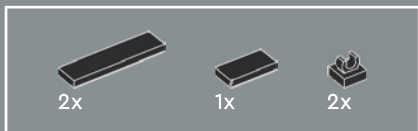

329

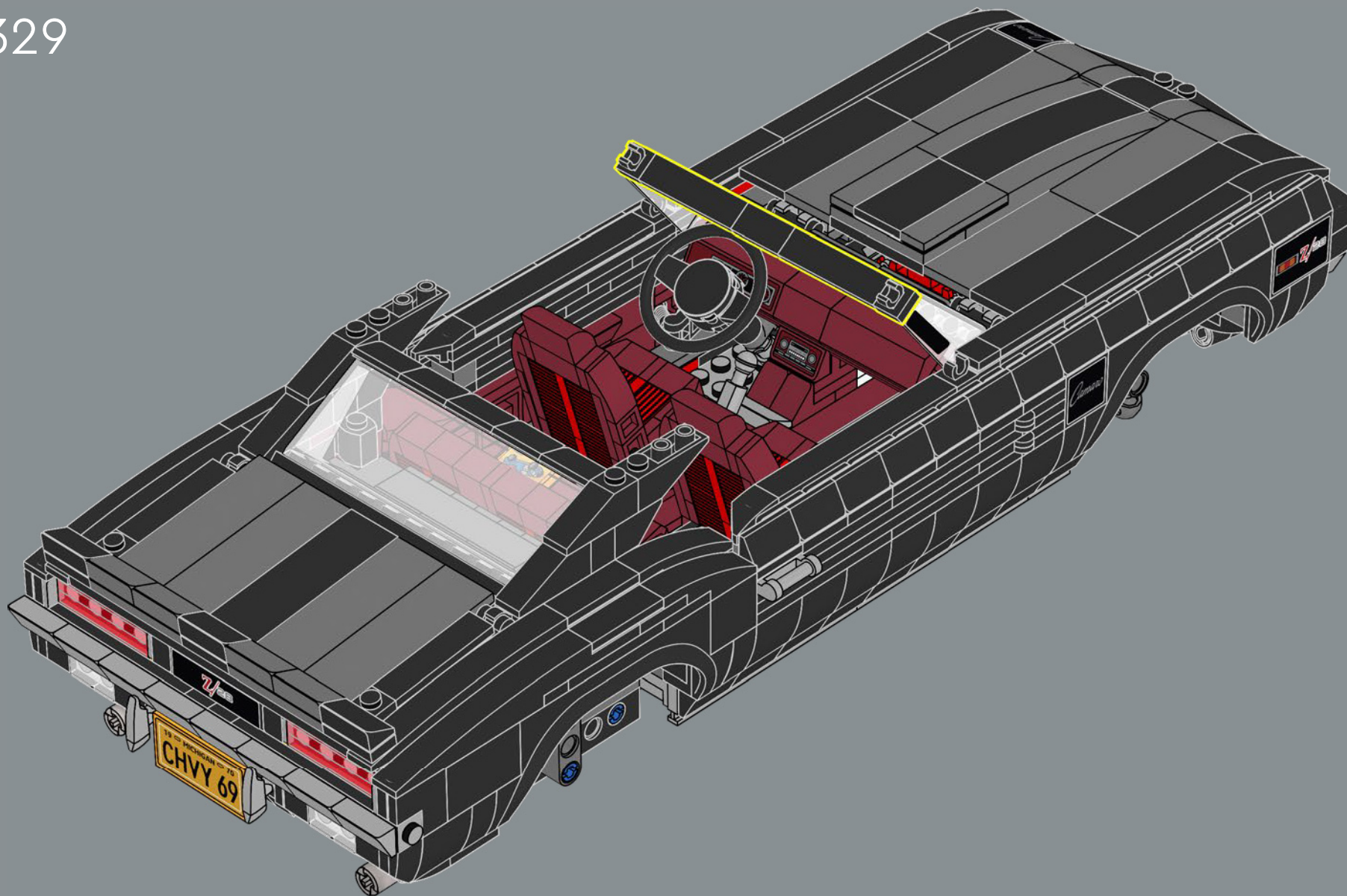

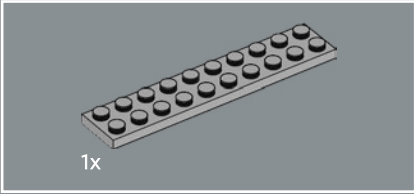
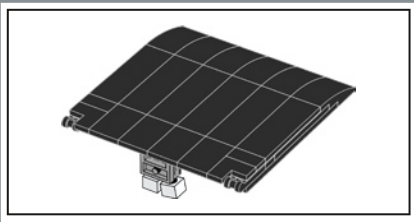

330

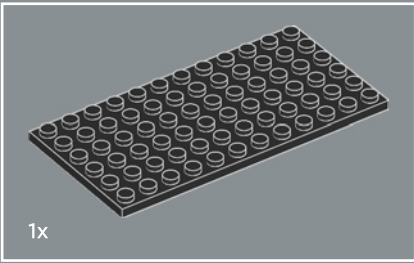
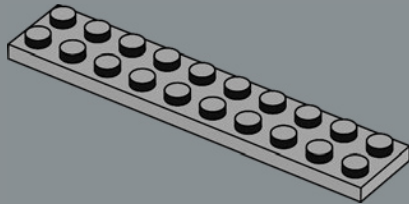

331

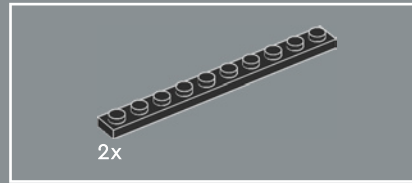
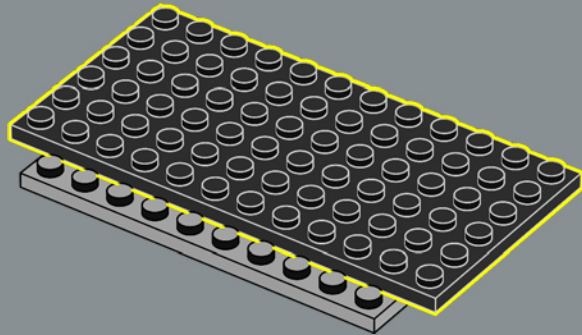

2x

332

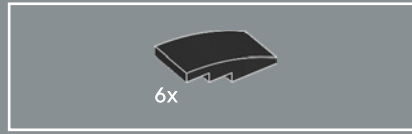
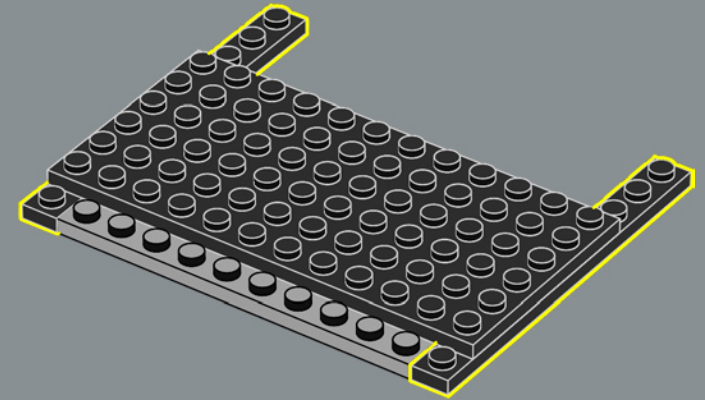

6x

333

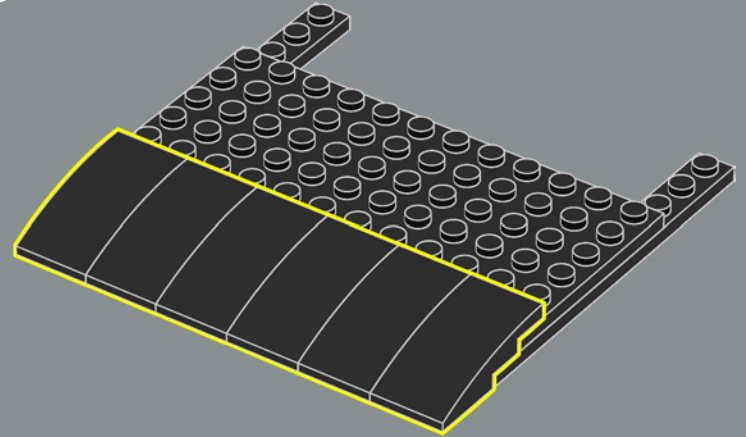

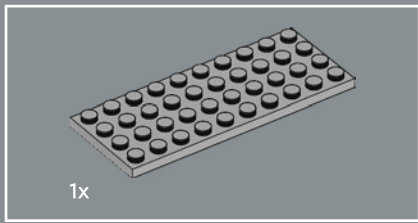

334

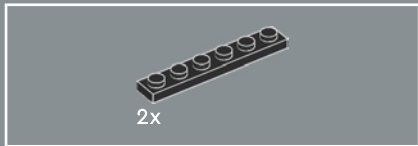
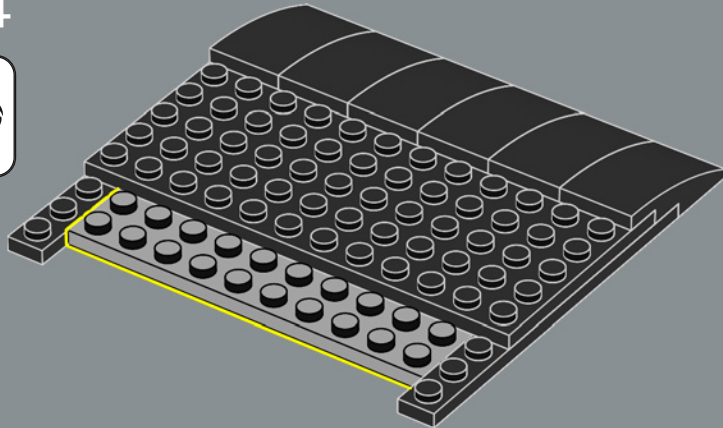

335

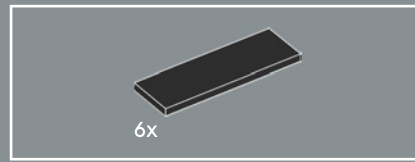
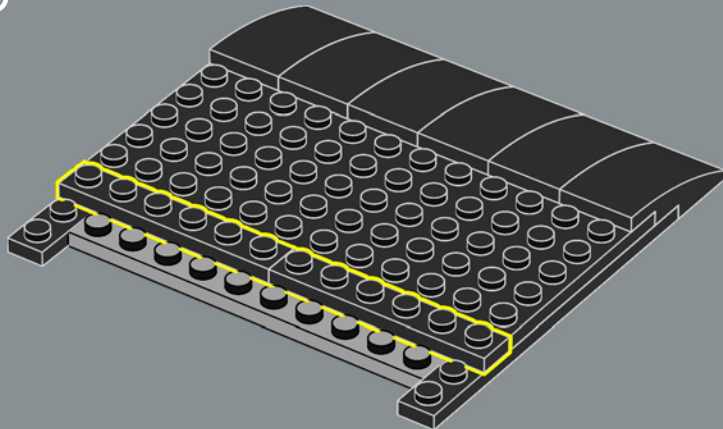

336

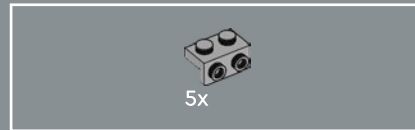
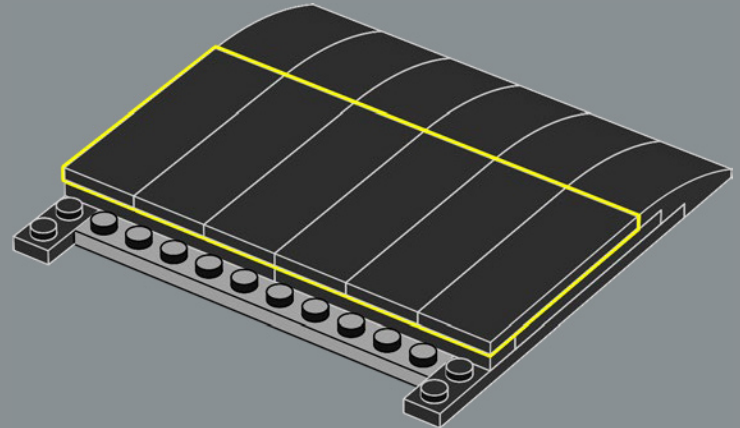

337

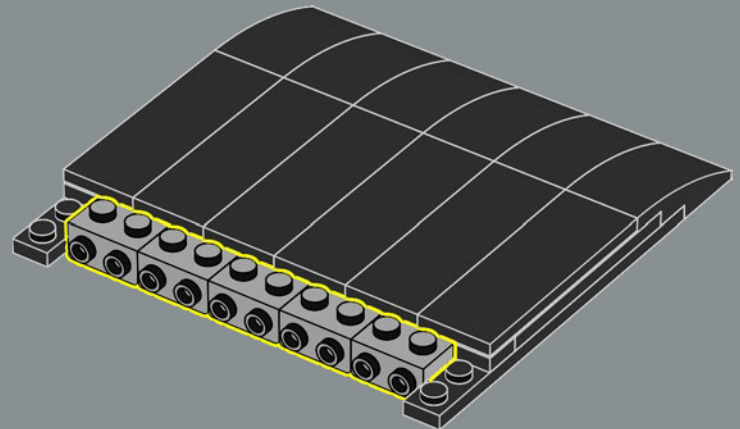

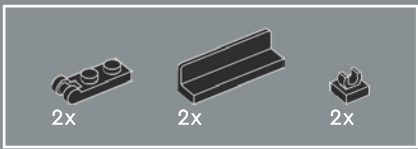

338

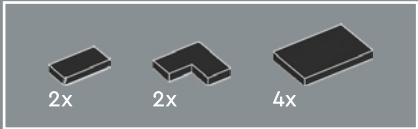
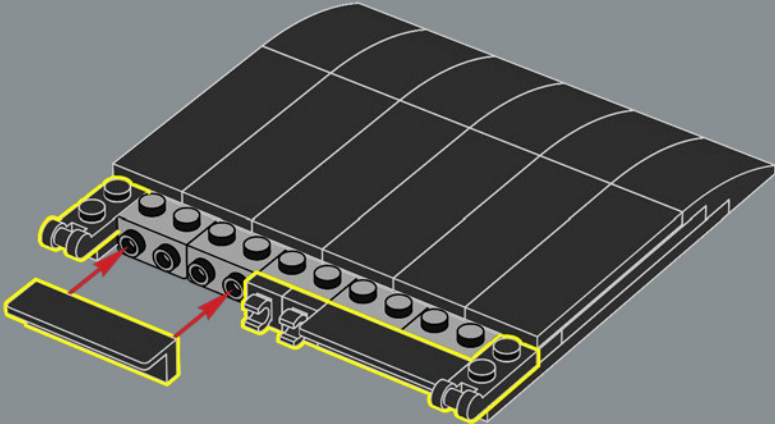

339

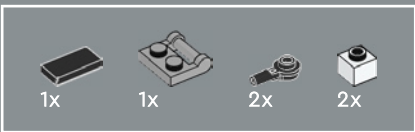
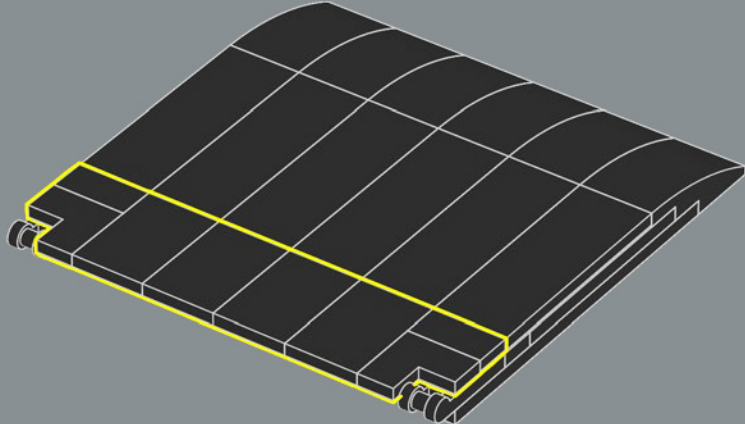

340

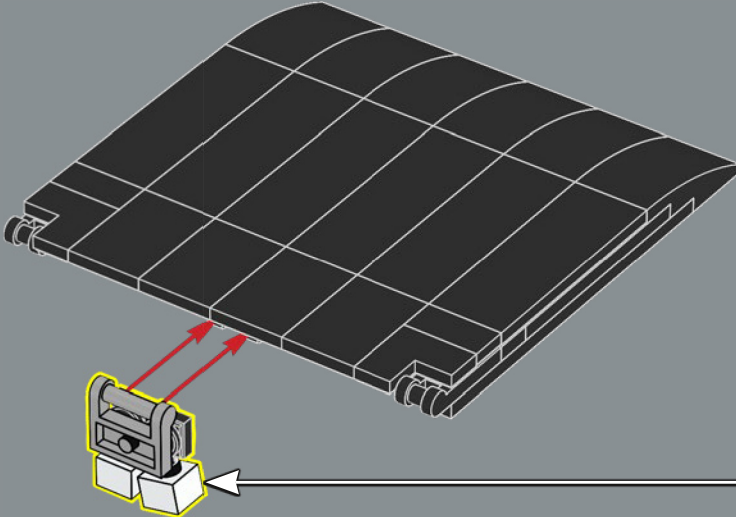
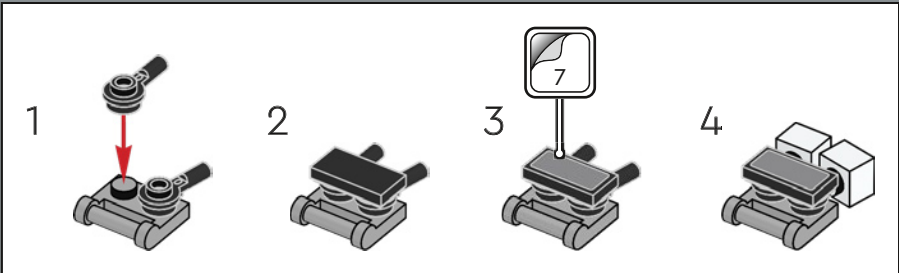

341

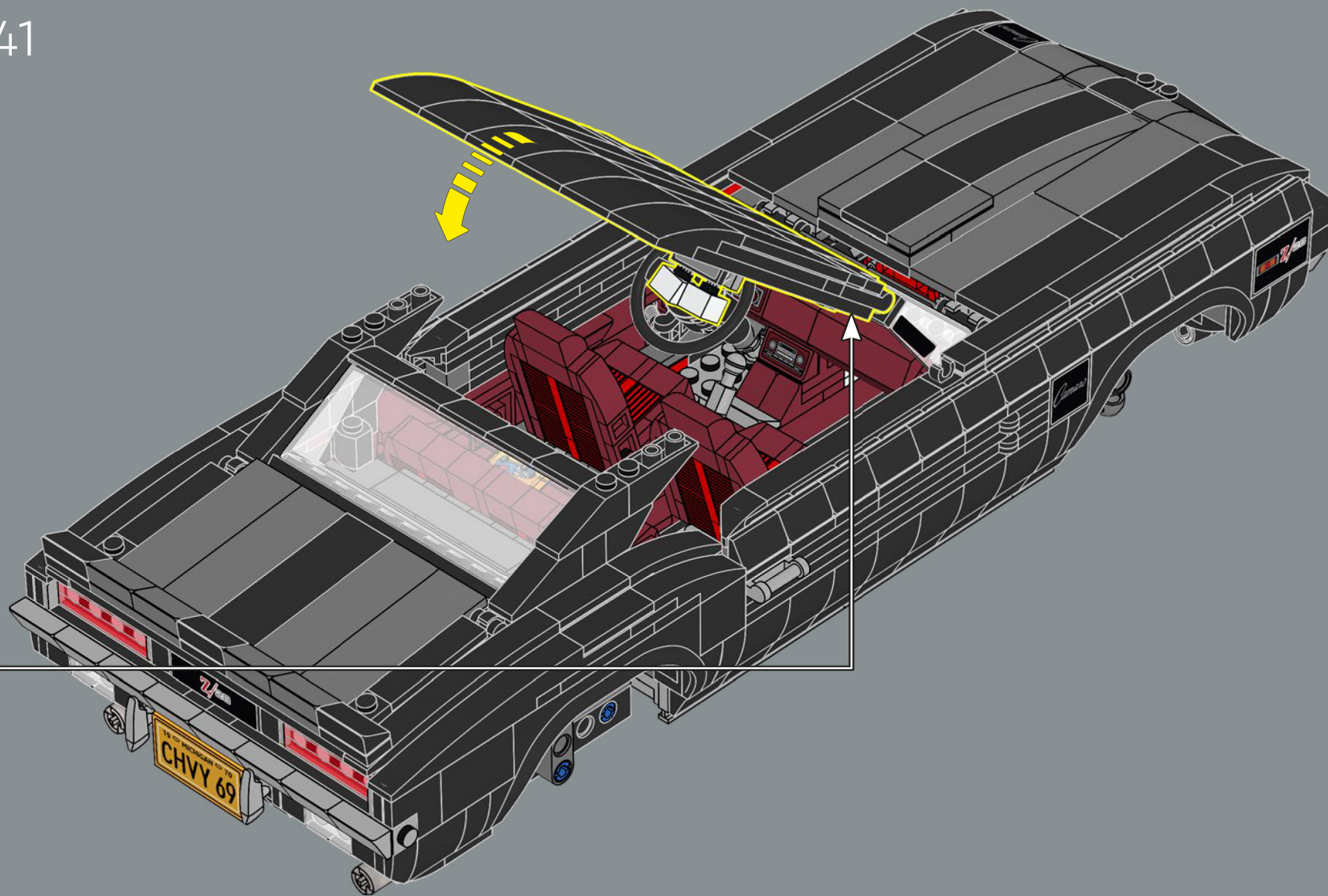

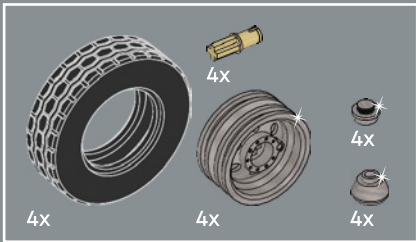
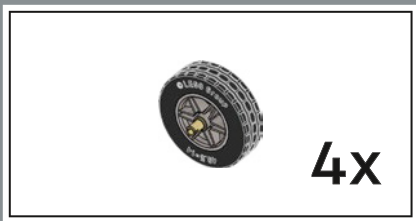

342

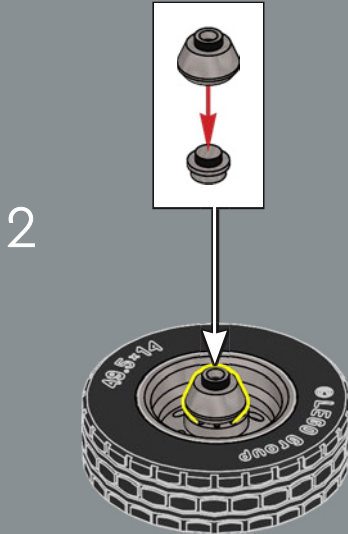
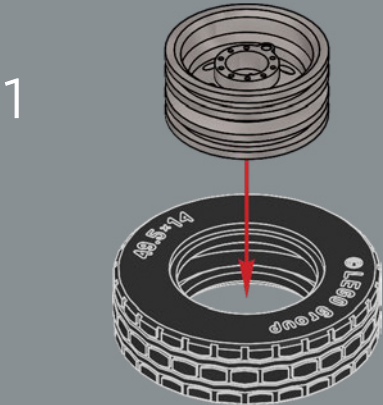

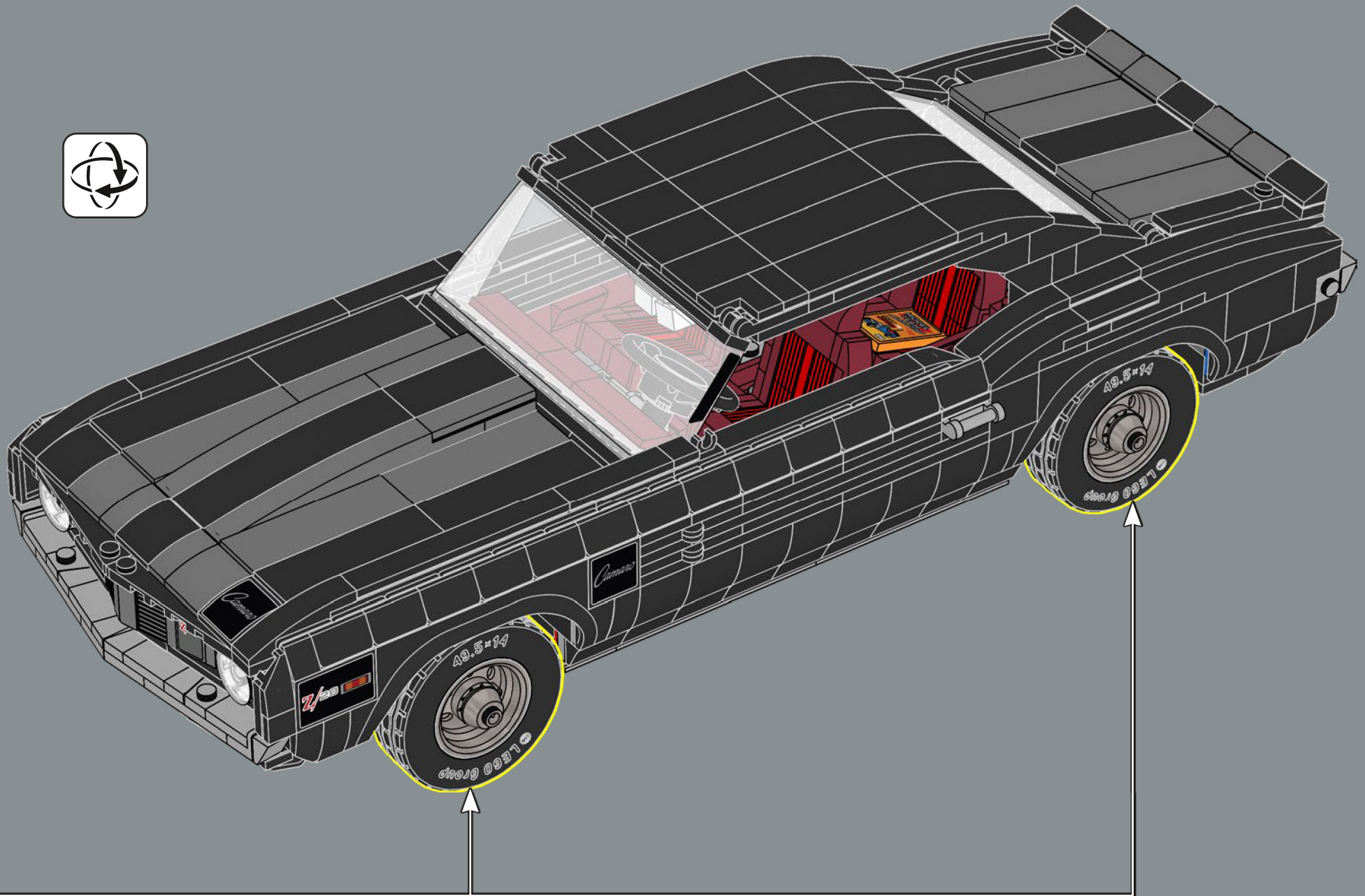



2x

343

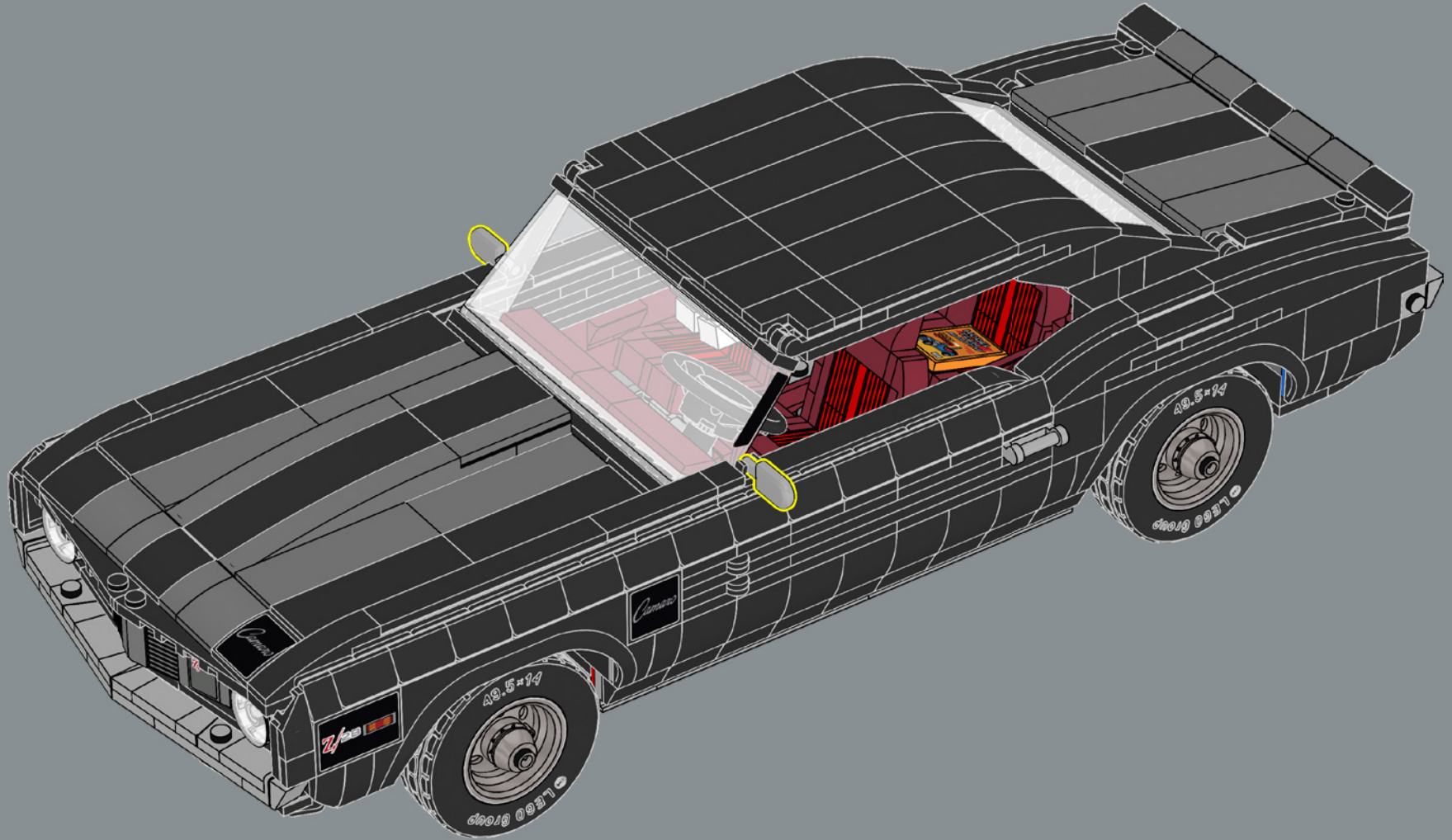

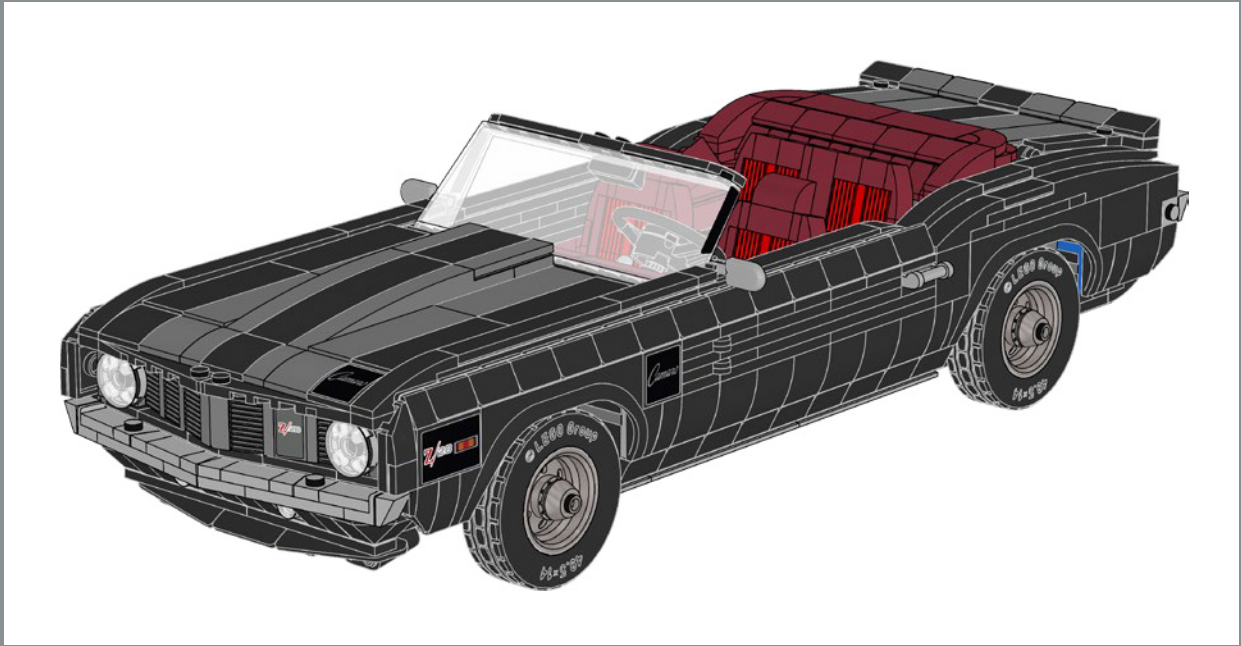

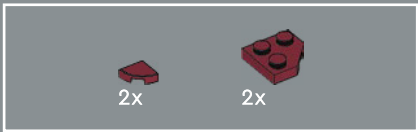

317

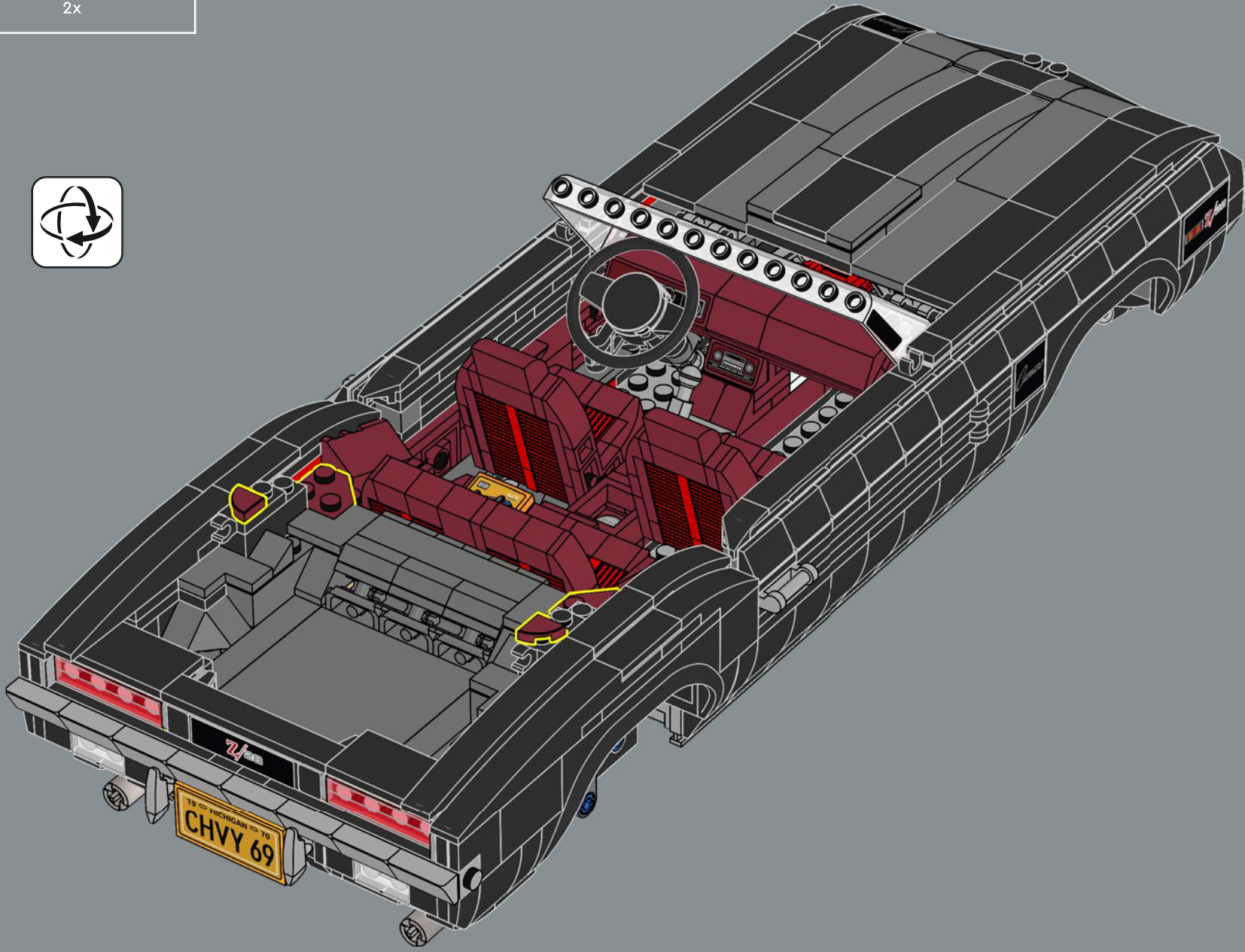

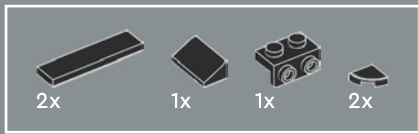

318

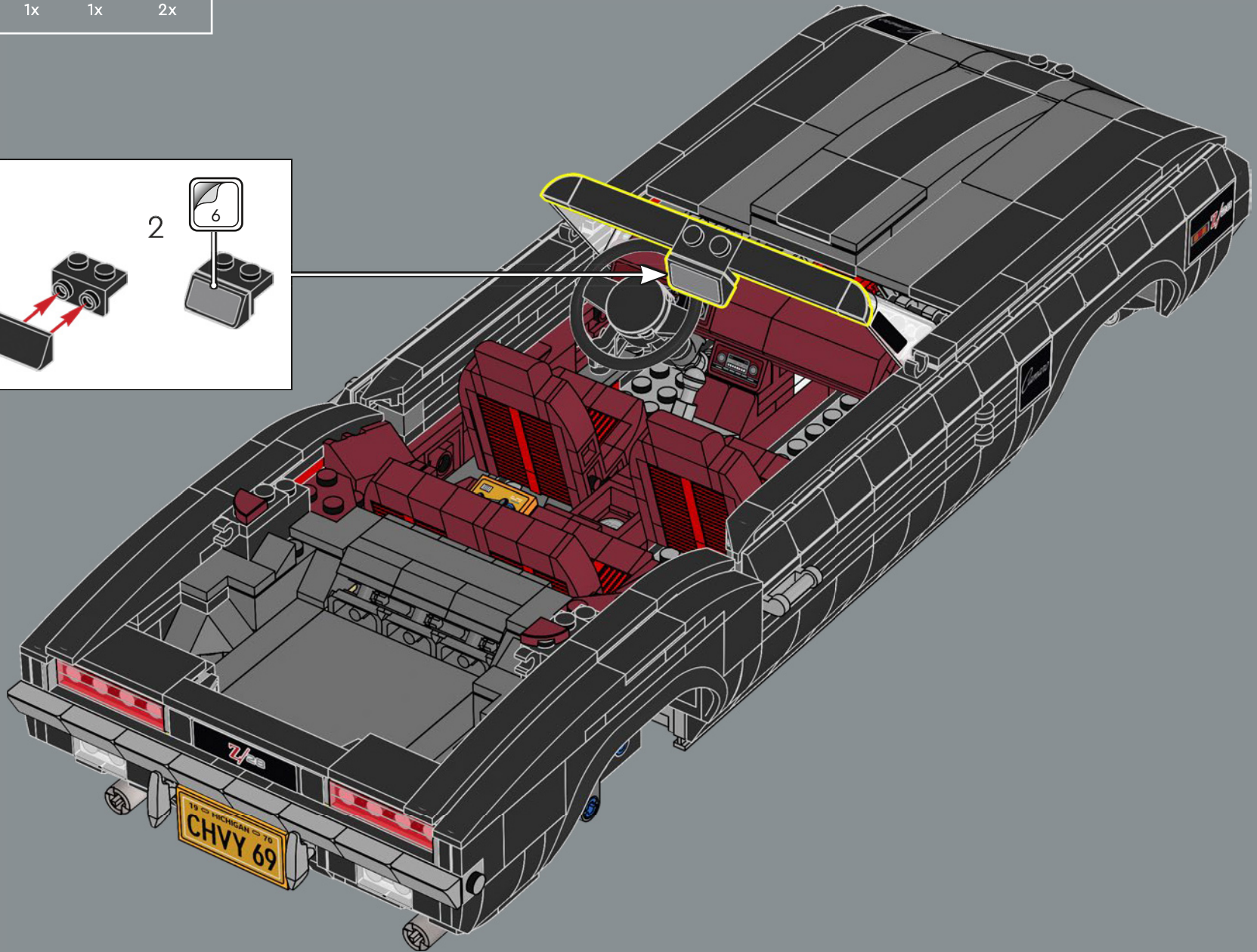
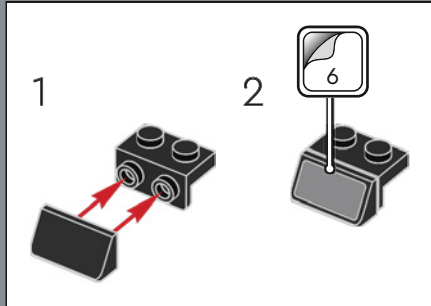

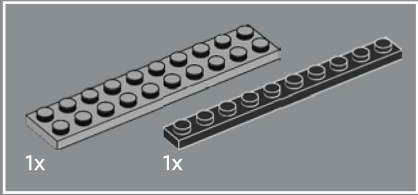

319

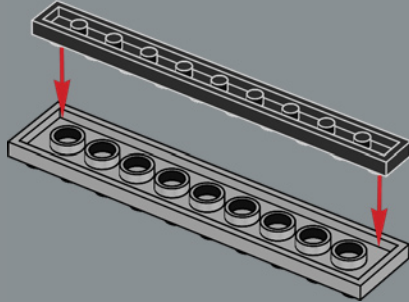

320

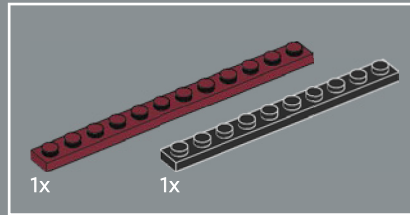
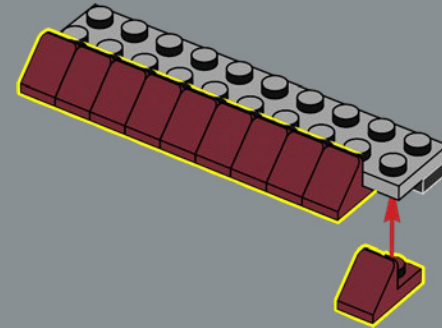

321

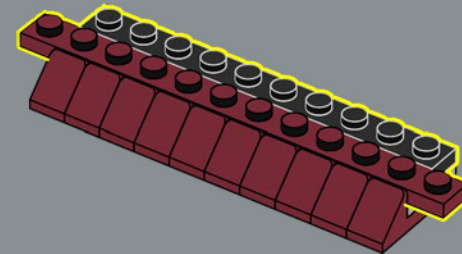

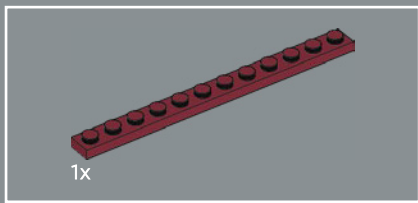

322

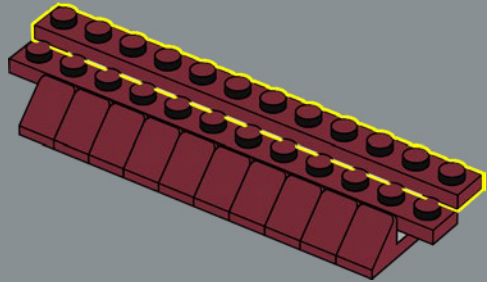

323

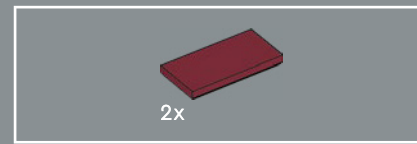
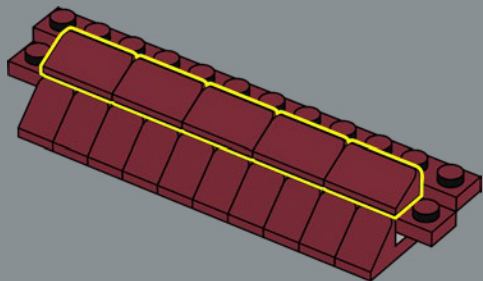

324

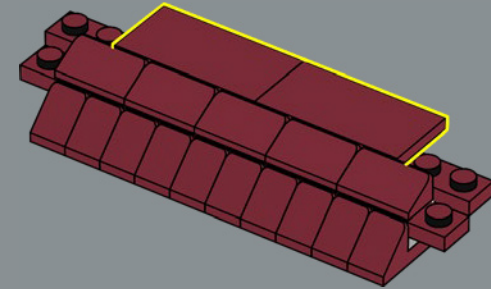

325

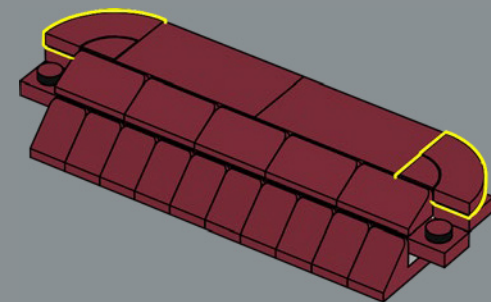

326

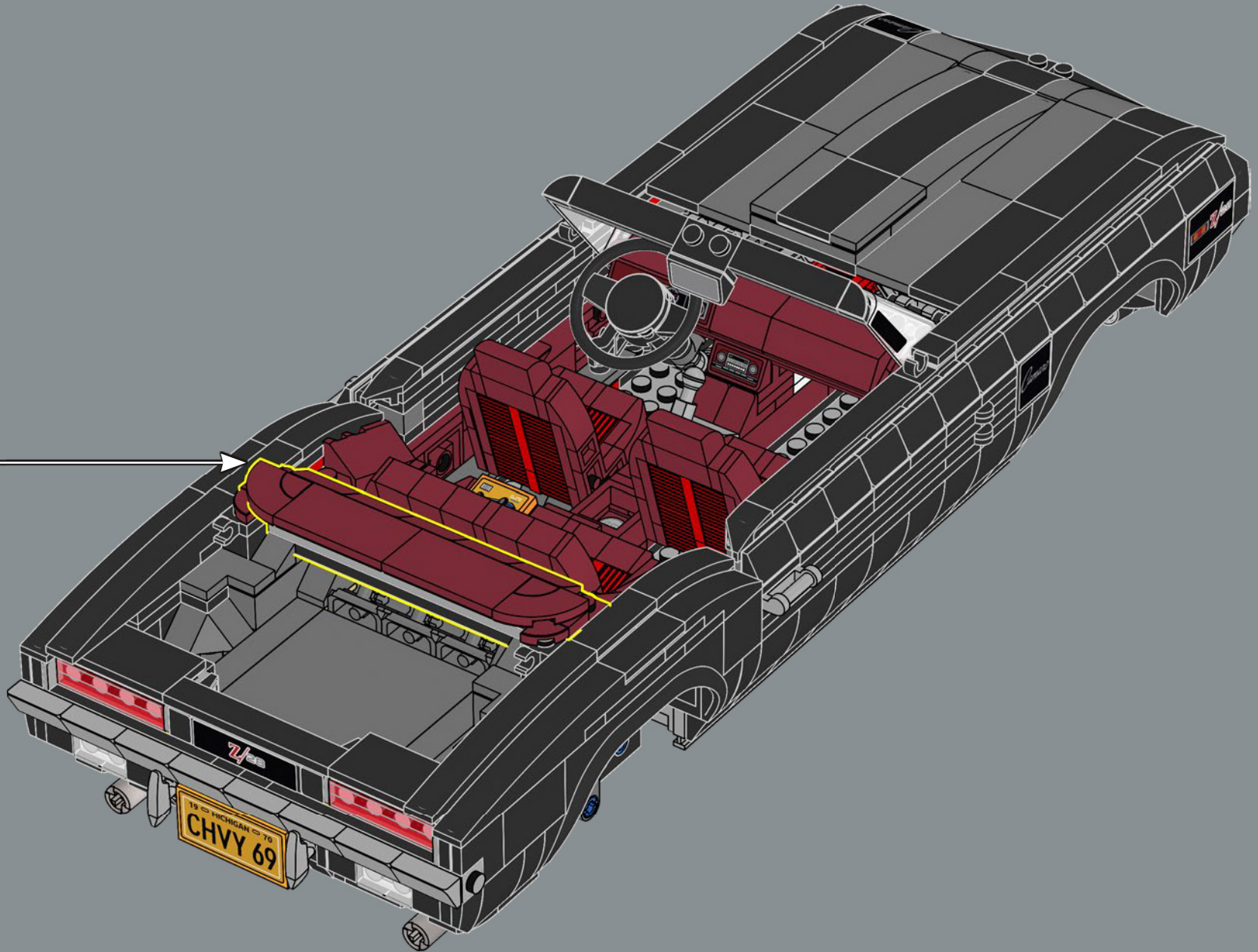

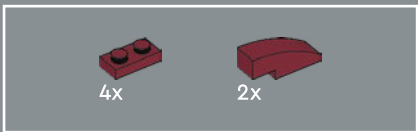

327

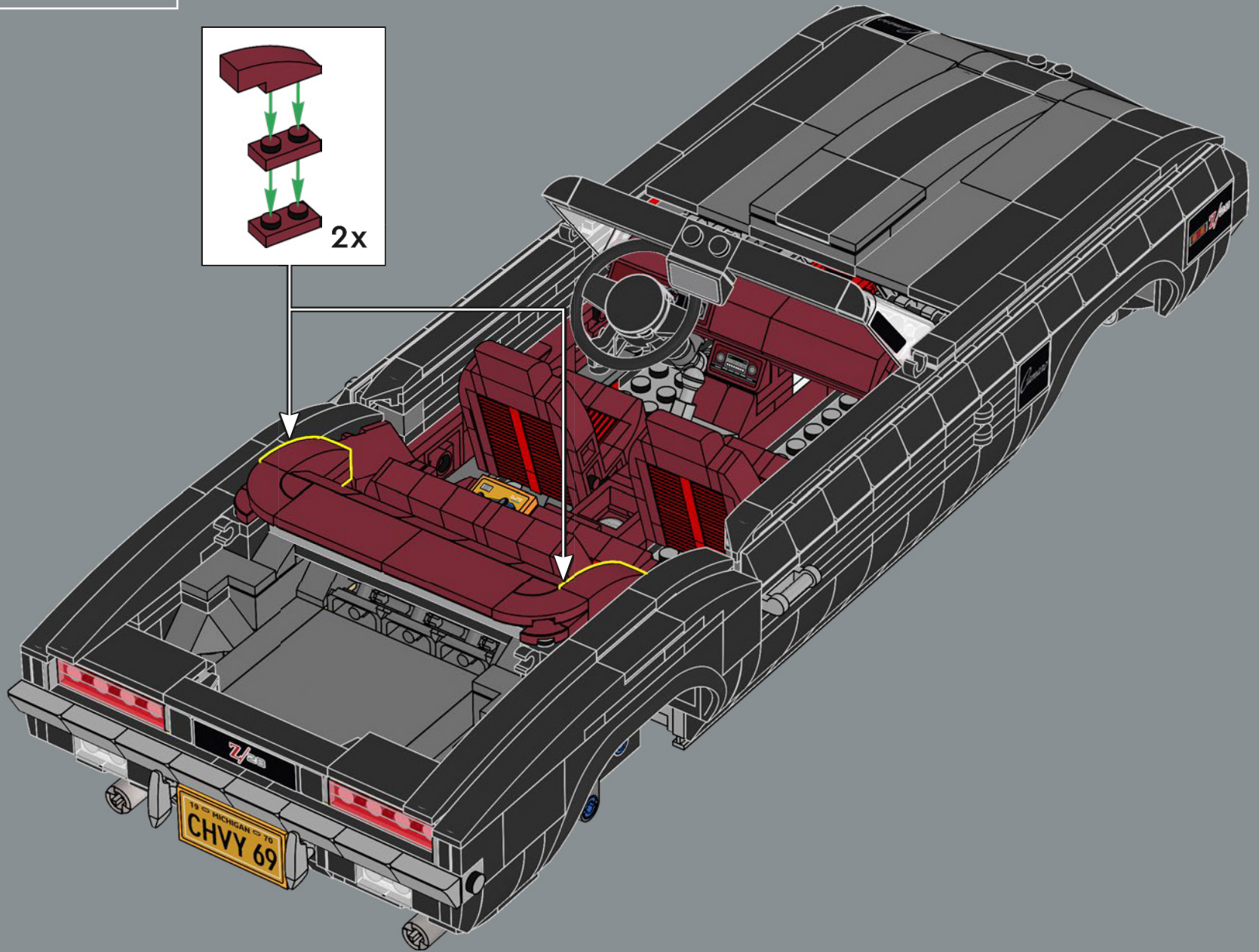
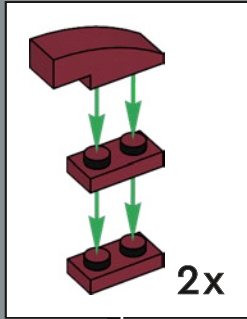

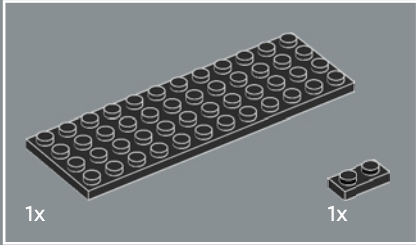
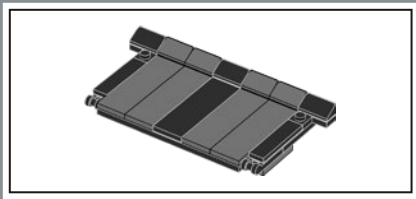

328

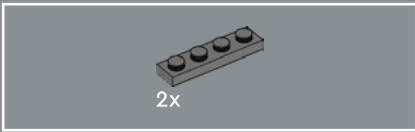
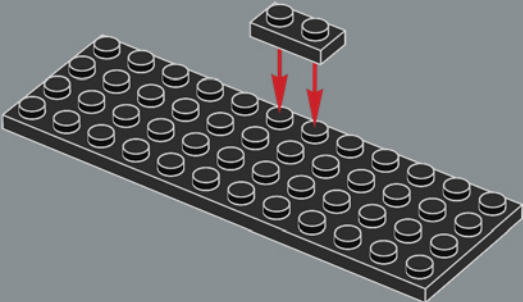

329

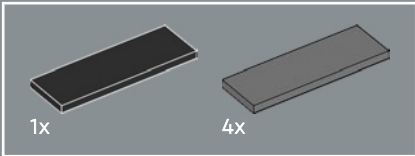
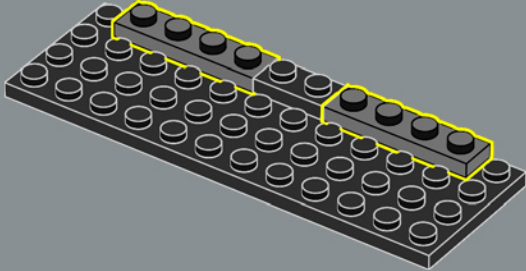

330

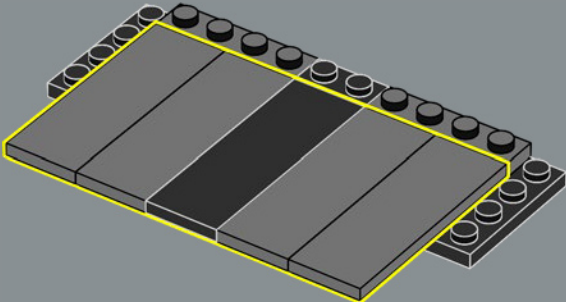

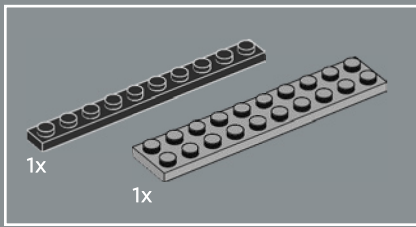

331

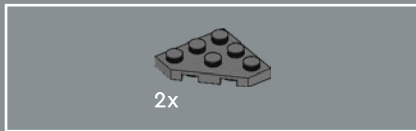
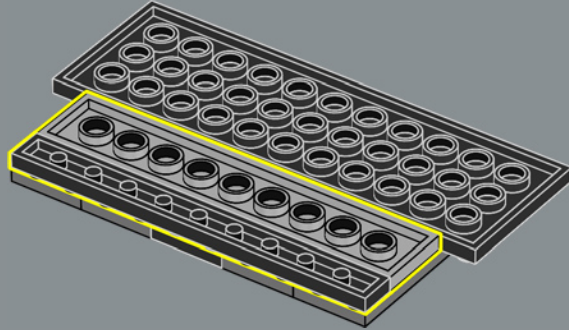

332

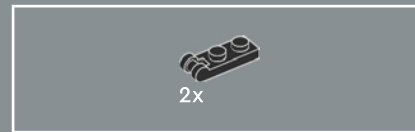
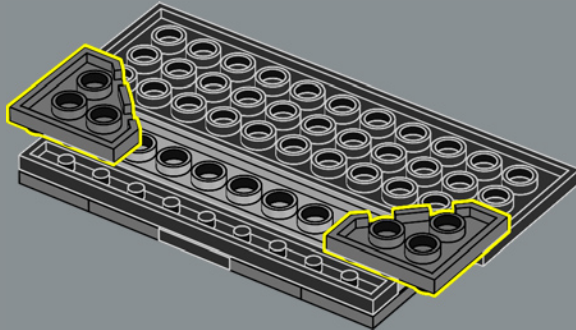

333

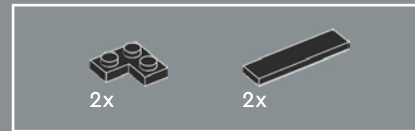
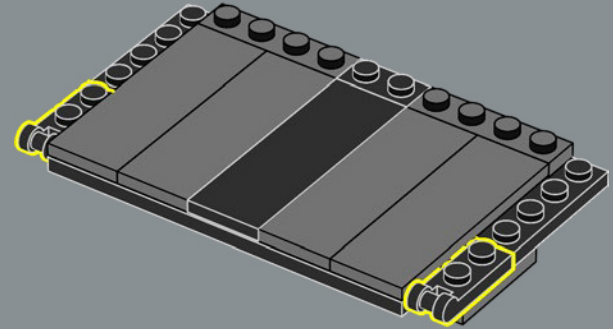

334

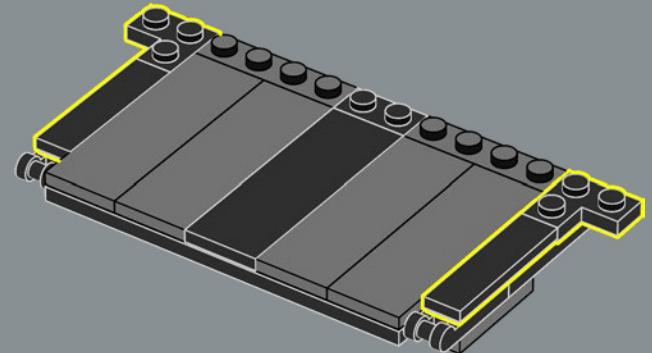



335

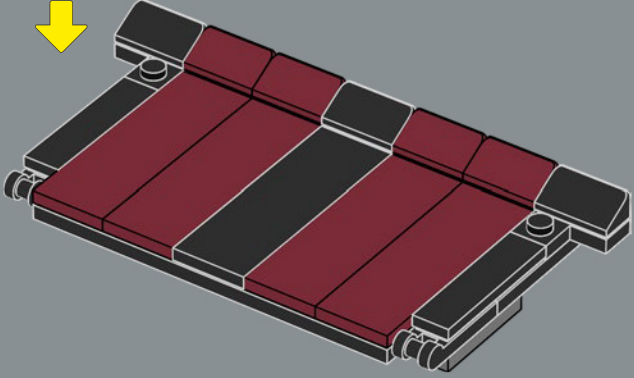
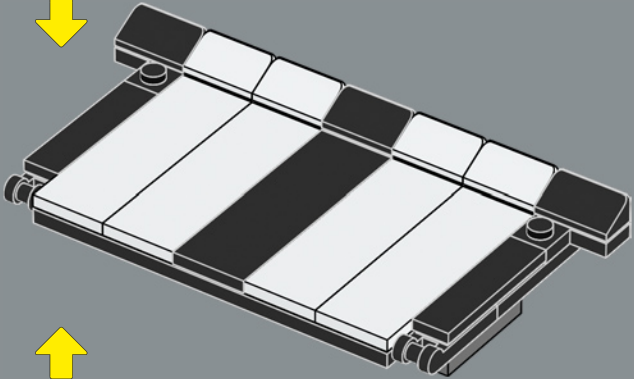
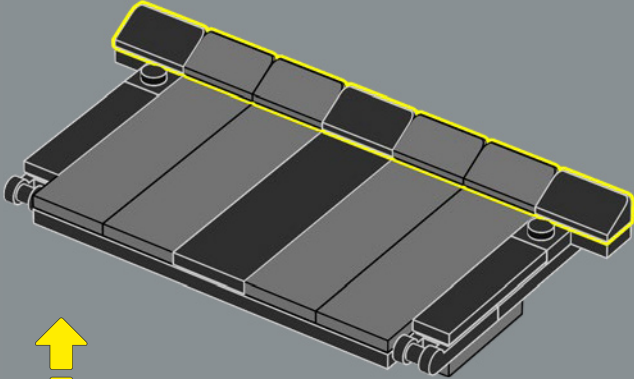

336

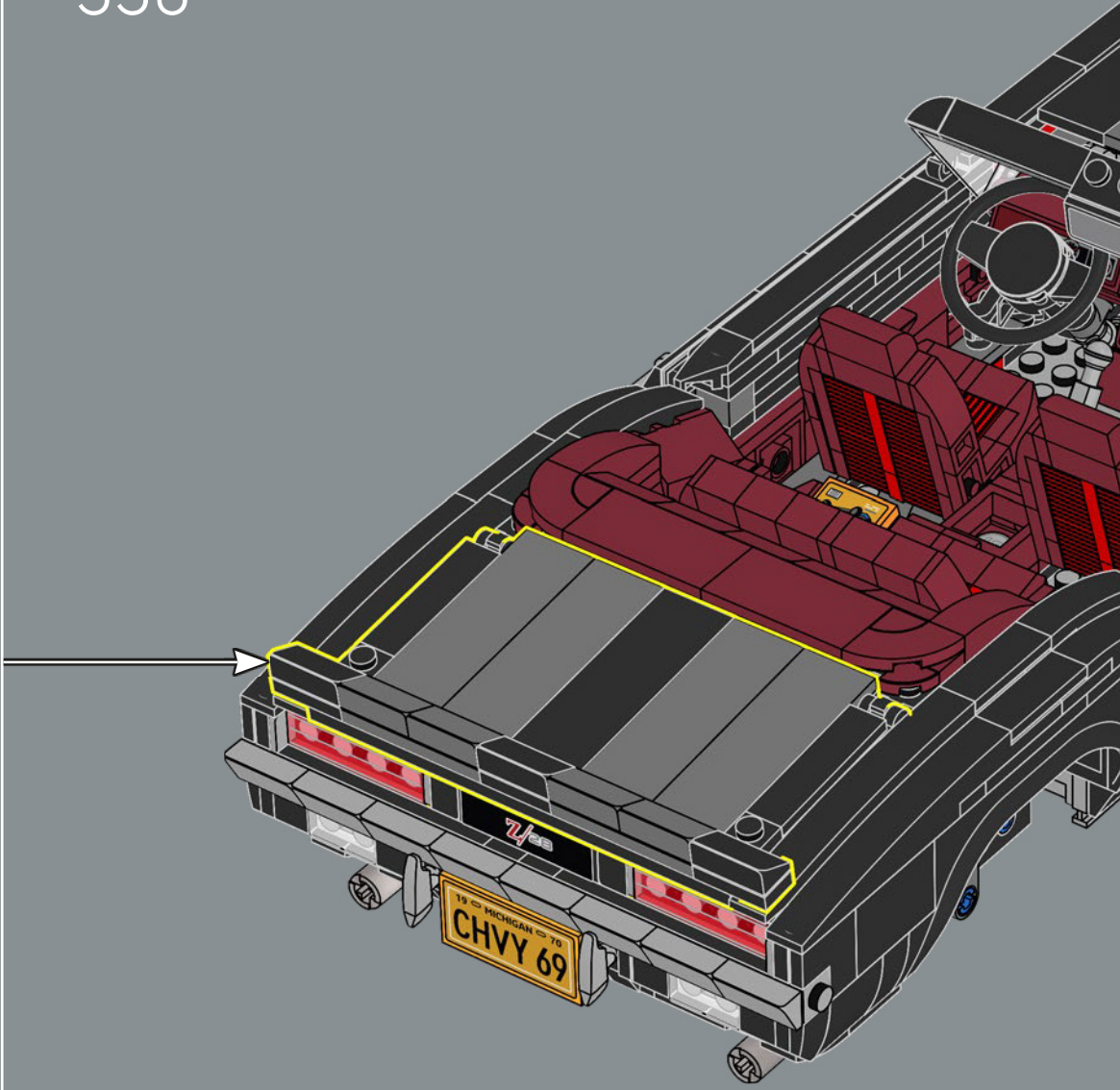

Une réplique en édition limitée de la Camaro Z11, la voiture de sécurité des 500 miles d'Indianapolis de 1969, reste l'un des modèles Camaro les plus recherchés.

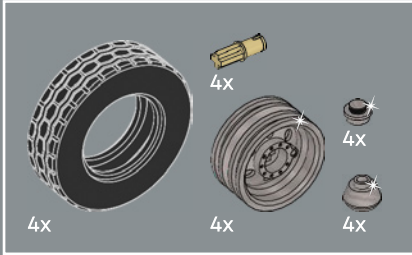
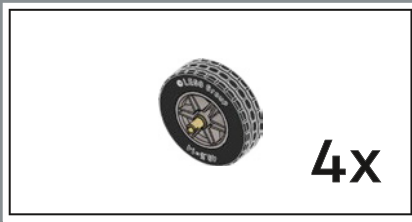

337

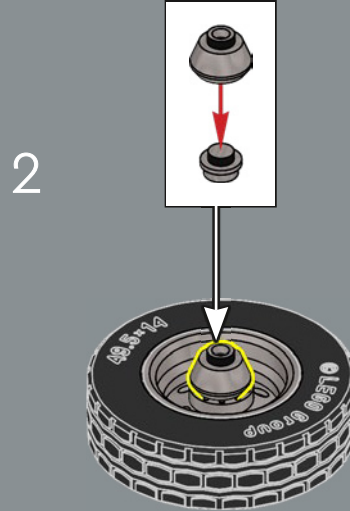
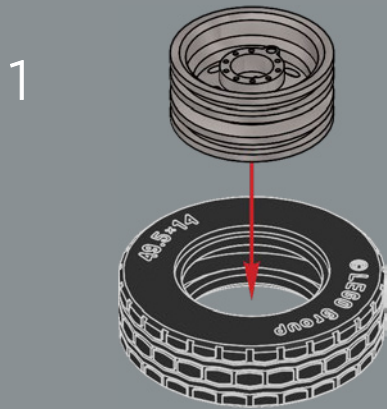

4x

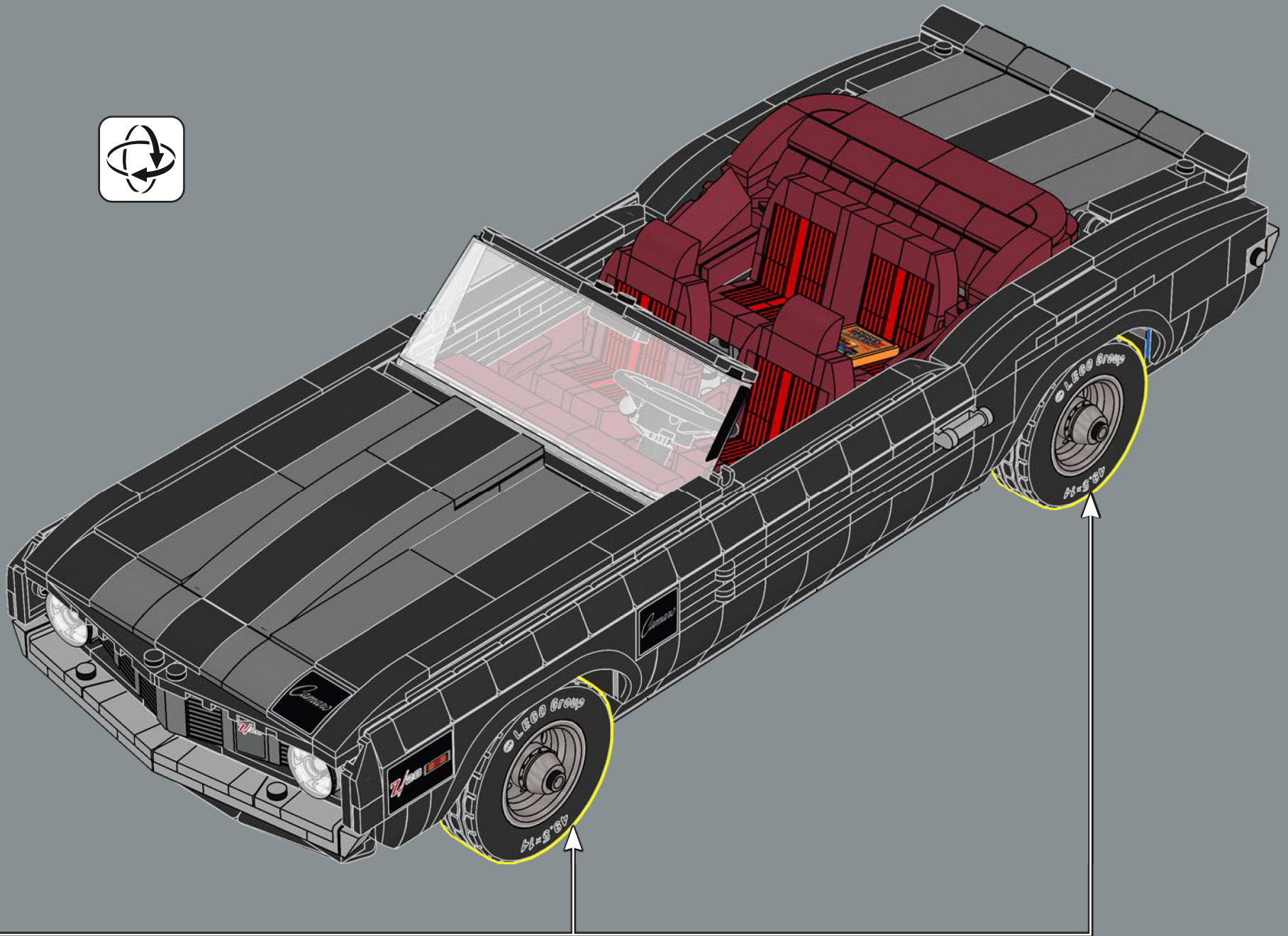



338

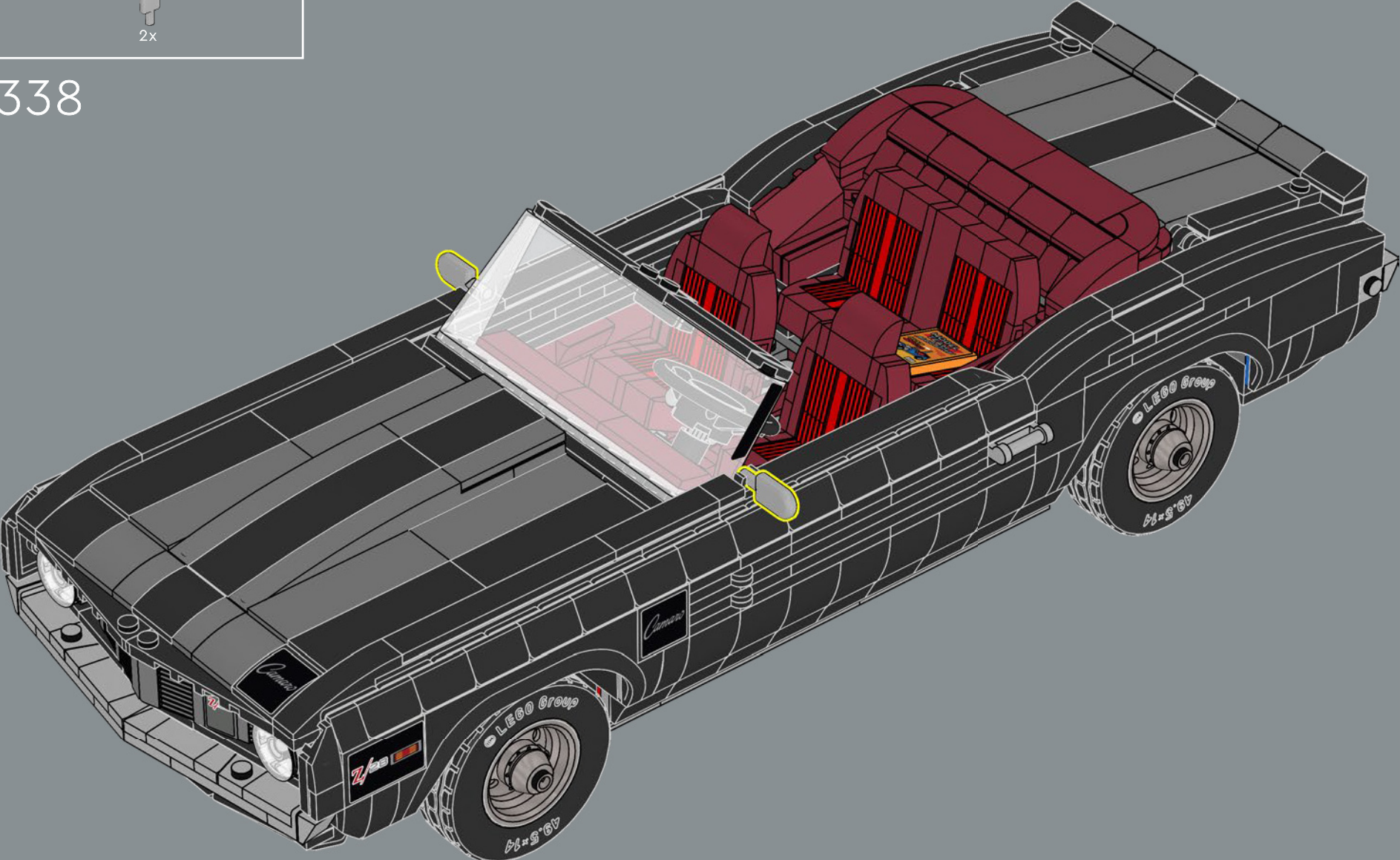

- 4x 4547489
- 2x 6034044
- 2x 6047220
- 4x 6276981
- 2x 6383985
- 4x 302201
- 2x 243101
- 2x 371001
- 2x 6104805
- 3x 302001
- 8x 6332042
- 2x 6035405
- 2x 6242241
- 3x 6347287
- 1x 6265740
- 2x 6146525
- 2x 614101
- 1x 6371416
- 1x 6289797
- 2x 4162465
- 8x 4118793
- 2x 6360037
- 8x 6024495
- 6x 4523145
- 8x 4121921
- 3x 4143409
- 3x 4249019
- 6x 6253003
- 2x 6013938
- 4x 4666579
- 2x 6416525
- 24x 6219677
- 2x 300321
- 2x 4558886
- 1x 654121
- 2x 370021
- 2x 6385920
- 1x 6275178
- 1x 330021
- 2x 307021
- 2x 302321
- 4x 6092565
- 2x 306921
- 6x 362321
- 2x 6378120
- 12x 371021
- 1x 303221
- 1x 303421
- 2x 6337002
- 2x 6347308
- 6x 6261351
- 5x 6168634
- 1x 6266205
- 8x 6168619
- 1x 6271820
- 3x 4142865
- 4x 6347789
- 1x 6130002
- 6x 393721
- 2x 300223
- 6x 6290531
- 1x 4212411
- 1x 6171063
- 2x 6057802
- 2x 306923
- 4x 6252060
- 2x 6196596
- 3x 303423
- 3x 6117968
- 4x 4206482
- 10x 6299413
- 2x 393723
- 2x 300524
- 2x 235724
- 2x 654124
- 14x 302324
- 2x 6195183
- 2x 6271167
- 1x 6170294
- 1x 6331822
- 2x 366624
- 6x 6248833
- 10x 300526
- 2x 4644456
- 4x 300426
- 6x 362226
- 2x 300226
- 5x 301026
- 2x 4584274
- 3x 370226
- 4x 4504382
- 53x 4548180
- 2x 4121966
- 4x 6267487
- 6x 366526
- 12x 6069000
- 1x 303926
- 2x 6176768
- 4x 428626
- 6x 428726
- 1x 6064228
- 5x 6181720
- 4x 6273589
- 2x 4107558
- 4x 302426
- 2x 6388352
- 6x 307026
- 44x 302326
- 8x 306926
- 2x 6214807
- 14x 6192346
- 4x 306826
- 2x 6312724
- 10x 302226
- 6x 242026
- 4x 6133722
- 4x 6195271
- 1x 403226
- 5x 6181713
- 2x 6184784
- 10x 6047276
- 26x 6053077
- 2x 6211476
- 2x 4618880
- 2x 6280394
- 1x 6319983
- 1x 6316923
- 1x 6331026
- 6x 6037746
- 6x 4647286
- 1x 6296083
- 4x 6037664
- 6x 243126
- 6x 371026
- 7x 302026
- 4x 4560182
- 2x 6350415
- 3x 663626
- 12x 366626
- 11x 6318582
- 6x 416226
- 1x 303226
- 1x 395826
- 14x 447726

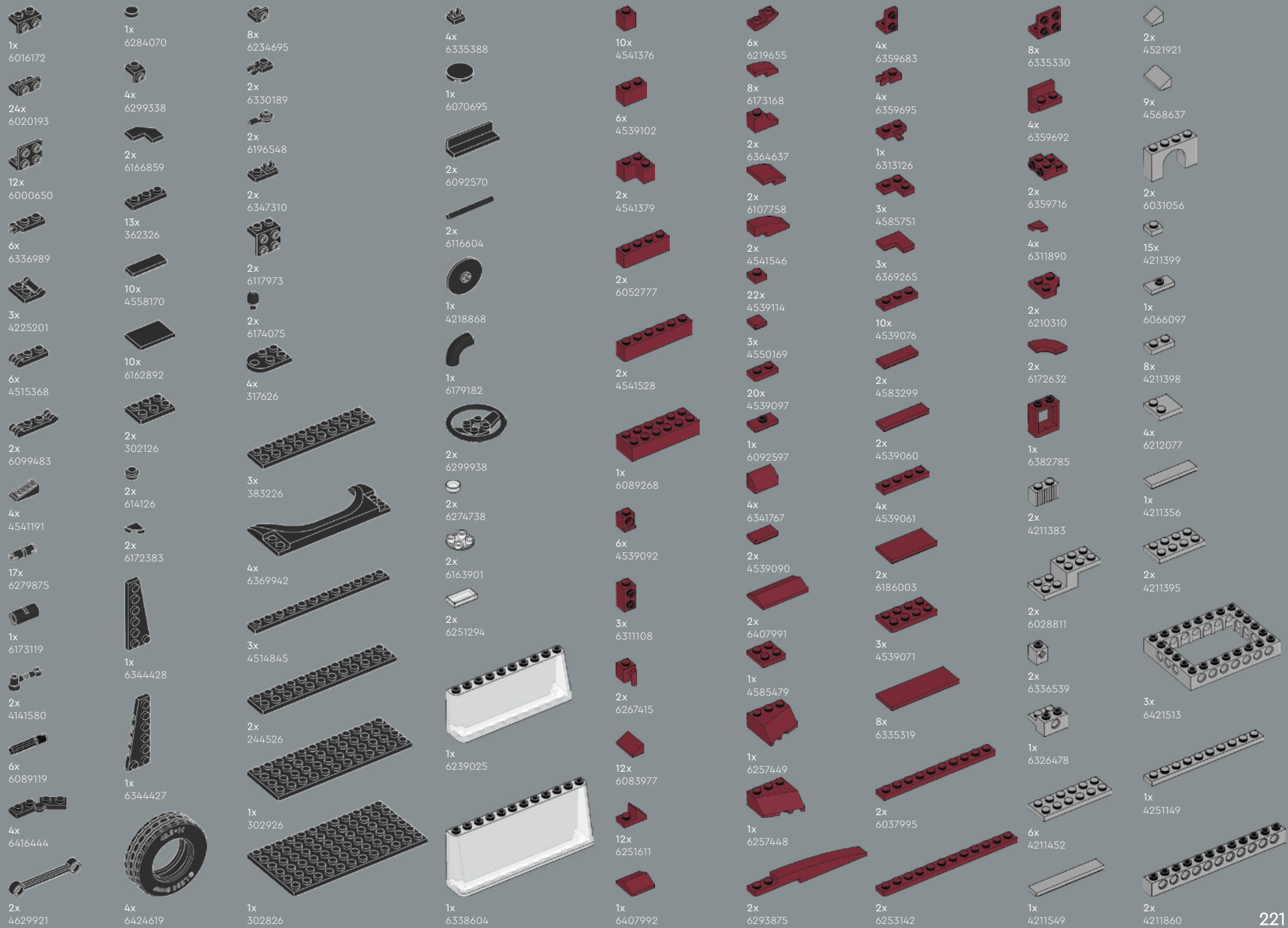

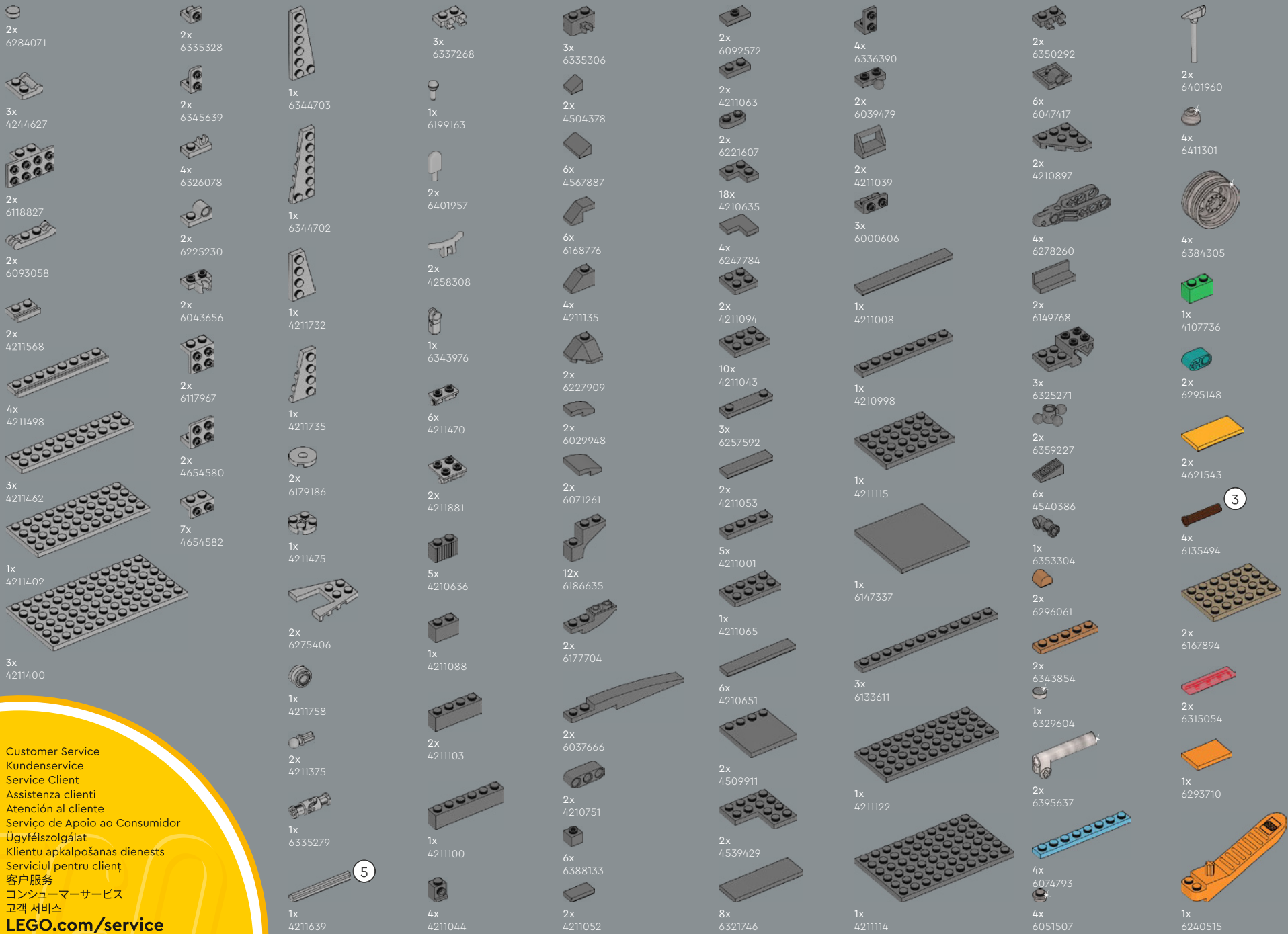

Customer Service
 Kundenservice
 Service Client
 Assistenza clienti
 Atención al cliente
 Serviço de Apoio ao Consumidor
 Ügyfélszolgálat
 Klientu apkalpošanas dienests
 Serviciul pentru clienț
 客户服务
 コンシューマーサービス
 고객 서비스
LEGO.com/service



FEEDBACK AND WIN



FEEDBACK AND WIN

Your feedback will help shape the future development of this product series.

Please visit:

FEEDBACK UND GEWINNEN

Dein Feedback trägt zur Weiterentwicklung dieser Produktreihe bei.

Geh auf:

COMMENTEZ ET GAGNEZ

Vos commentaires nous aideront à concevoir les futurs produits de cette gamme.

Rendez-vous sur :

COMENTA Y GANA

Tu opinión nos ayudará a dar forma al desarrollo de esta serie de productos en el futuro.

Visita:

反馈有奖

您的反馈将有助于我们在今后改进本系列产品。

请访问：

[LEGO.com/productfeedback](https://www.lego.com/productfeedback)

By completing, you will automatically enter a drawing to win a LEGO® set.

Terms & Conditions apply.

Durch Ausfüllen nimmst du automatisch an der Verlosung eines LEGO® Preises teil.

Es gelten die Teilnahmebedingungen.

En envoyant vos commentaires, vous serez automatiquement inscrit(e) à un tirage au sort qui vous permettra de remporter un prix LEGO®.

Offre soumise à conditions.

Al contestar, participarás automáticamente en el sorteo y podrás ganar un set LEGO®.

Sujeto a Términos y Condiciones.

完成我们的反馈调查，即可自动进入抽奖环节，赢取乐高®套装。

适用《条款和条件》。



LEGO and the LEGO logo are trademarks of the LEGO Group. ©2022 The LEGO Group.

General Motors trademarks used under license to the LEGO Group.